

Rail-to-Rail I/O, 100mA Output Single-Supply Amplifiers

Features

- Single-Supply Operation: 2.2 Volts to 6 Volts
- High Output Current: $\pm 100\text{mA}$
- Wide Bandwidth: 3.5 MHz
- Slew Rate: 6.2 V/ μs
- No Phase Reversal
- Unity Gain Stable
- Rail-to-Rail Input and Output

Applications

- Multimedia Audio
- LCD Driver
- ASIC Input or Output Amplifier
- Headphone Driver

General Description

The G1201 is dual rail-to-rail input and output single-supply amplifiers featuring 100mA output drive current. This high output current makes these amplifiers excellent for driving either resistive or capacitive loads. AC performance is very good with 3.5MHz bandwidth, 6.2V/ μs -slew rate and low distortion. All are guaranteed to operate from a +3 volt single supply as well as a +5 volt supply.

The very low input bias currents enable the G1201 to be used for integrators and diode amplification and other applications requiring low input bias current. Allowing low current applications to control high current loads.

Applications include audio amplification for computers, sound ports, sound cards and set-top boxes. The G1201 is very stable and capable of driving heavy capacitive loads.

The ability to swing rail-to-rail at the inputs and outputs enables designers to buffer CMOS ADC/DACs, ASICs or other wide output swing devices in single-supply systems.

Ordering Information

PART	TEMP. RANGE	PIN-PACKAGE
G1201	-40°C to +85°C	8 SOP

Pin Configuration

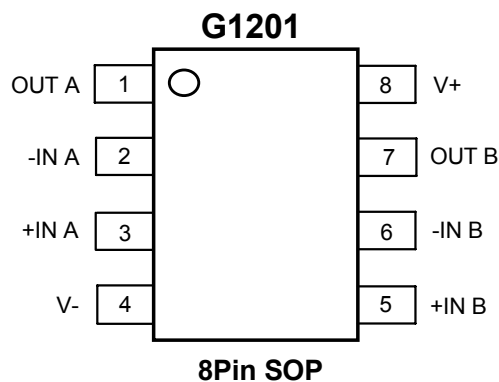

Rail-to-Rail is a registered trademark of Nippon Motorola, Ltd.

Absolute Maximum Ratings*

Supply Voltage (V_S).....+7V
 Input VoltageGND to V_S
 Differential Input Voltage**..... $\pm 6V$
 Storage Temperature Range.....-65°C to +150°C
 Operating Temperature Range.....-40°C to +85°C
 Junction Temperature Range.....-65°C to +150°C

Lead Temperature Range (Soldering, 60 sec)...+300°C
 θ_{JA}^1150°C/W
 θ_{JC}43°C/W
¹ θ_{JA} is specified for the worst case conditions, θ_{JA} is specified for device soldered onto a circuit board for surface-mount packages.

*Stresses above those listed under Absolute Maximum Ratings may cause permanent damage to the device. This is a stress rating only; the functional operation of the device at these or any other conditions above those indicated in the operational sections of this specification is not implied. Exposure to absolute maximum rating conditions for extended periods may affect device reliability.

**For supplies less than +6V, the differential input voltage is equal to $\pm V_S$.

Electrical Characteristics ($V_S = +3.0V$, $V_{CM} = 1.5V$, $T_A = +25^\circ C$ unless otherwise noted)

PARAMETER	SYMBOL	CONDITIONS	MIN	TYP	MAX	UNIT
Input Characteristics						
Offset Voltage	V_{OS}			5	15	mV
Input Bias Current	I_B			50	250	pA
Input Offset Current	I_{OS}			25	125	pA
Input Voltage Range	V_{CM}		0		3	V
Common-Mode Rejection Ratio	CMRR	$V_{CM} = 0V$ to $3V$		60		dB
Large Signal Voltage Gain	A_{VO}	$R_L = 2k\Omega$ $V_O = 0.5V$ to $2.5V$		80		dB
Output Characteristics						
Output Voltage High	V_{OH}	$I_L = 10mA$	2.85	2.91		V
Output Voltage Low	V_{OL}	$I_L = 10mA$		60	100	mV
Output Current	I_{OUT}			± 100		mA
Power Supply						
Power Supply Rejection Ratio	PSRR	$f_i = 1k$ $V_{ripple(PEAK)} = 1V$		63		dB
Supply Current/Amplifier	I_{SY}	$V_O = 0V$		1.5	2.5	mA
Dynamic Performance						
Slew Rate	SR	$R_L = 2k\Omega$		2.8		V/ μs
Settling Time	t_s	To 0.1%		2.5		μs
Gain Bandwidth Product	GBP			2.2		MHz
Channel Separation	CS	$f = 1kHz$ $R_L = 32\Omega$		70		dB
Total Harmonic Distortion	THD	$f = 1kHz$ $A_V = -1$ $R_L = 32\Omega$ $V_{O(P-P)} = 2.45V$		50		dB

Specifications subject to change without notice.

Electrical Characteristics ($V_S = +5.0V$, $V_{CM} = 2.5V$, $T_A = +25^\circ C$ unless otherwise noted)

PARAMETER	SYMBOL	CONDITIONS	MIN	TYP	MAX	UNIT
Input Characteristics						
Offset Voltage	V_{OS}			5	15	mV
Input Bias Current	I_B			50	500	pA
Input Offset Current	I_{OS}			25	250	pA
Input Voltage Range	V_{CM}		0		5	V
Common-Mode Rejection Ratio	CMRR	$V_{CM} = 0V$ to $5V$	40	65		dB
Large Signal Voltage Gain	A_{VO}	$R_L = 2k\Omega$ $V_O = 0.5V$ to $4.5V$	70	90		dB
Output Characteristics						
Output Voltage High	V_{OH}	$I_L = 10mA$	4.90	4.94		V
Output Voltage Low	V_{OL}	$I_L = 10mA$		50	100	mV
Output Current	I_{OUT}			± 100		mA
Power Supply						
Power Supply Rejection Ratio	PSRR	$f_i = 1kHz$ $V_{ripple(PK)} = 1V$	50	66		dB
Supply Current/Amplifier	I_{SY}	$V_O = 0V$		3.5	6	mA
Dynamic Performance						
Slew Rate	SR	$R_L = 2k\Omega$		6.2		V/ μs
Full-Power Bandwidth	BW_p	$R_L = 32\Omega$ $V_{O(P-P)} = 4.2V$ THD = 50dB		30		kHz
Settling Time	t_s	To 0.1%		1.3		μs
Gain Bandwidth Product	GBP			3.5		MHz
Channel Separation	CS	$f = 1kHz$, $R_L = 32\Omega$		70		dB
Total Harmonic Distortion	THD	$f = 1kHz$, $A_V = -1$, $R_L = 32\Omega$, $V_{O(P-P)} = 4.3V$		50		dB

Specifications subject to change without notice.

Caution

ESD (electrostatic discharge) sensitive device. Electrostatic charges as high as 2000V readily accumulate on the human body and test equipment and can discharge without detection.

Although the G1201 feature proprietary ESD protection circuitry, permanent damage may occur on devices subjected to high-energy electrostatic discharges. Therefore, proper ESD precautions are recommended to avoid performance degradation or loss of functionality.

Applications

Theory of Operation

The G1201 is an all-CMOS, high output current drive, rail-to-rail input/output operational amplifier. Its high output current drive and stability with heavy capacitive loads makes the G1201 an excellent choice as a drive amplifier.

Short-Circuit Protection

As a result of the design of the output stage for maximum load current capability, the G1201 does not have

any internal short-circuit protection circuitry. Direct connection of the G1201's output to the positive supply in single-supply applications will destroy the device. In those applications where some protection is needed, but not at the expense of reduced output voltage headroom, a low value resistor in series with the output, as shown in Figure 1, can be used. The resistor, connected within the feedback loop of the amplifier, will have very little effect on the performance of the amplifier other than limiting the maximum available output voltage swing.

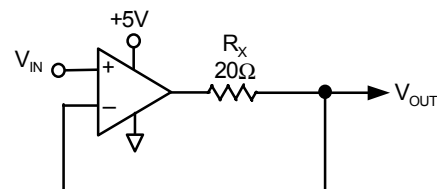

Figure 1. Output Short-Circuit Protection

Input Overvoltage Protection

As with any semiconductor device, whenever the condition exists for the input to exceed either supply voltage, the device's input overvoltage characteristic must be considered. When an overvoltage occurs, the amplifier could be damaged depending on the magnitude of the applied voltage and the magnitude of the fault current. Although not shown here, when the input voltage exceeds either supply by more than 0.6V, pn-junctions internal to the G1201 energize allowing current to flow from the input to the supplies. The G1201 does not have any internal current limiting resistors, so fault currents can quickly rise to damaging levels.

This input current is not inherently damaging to the device as long as it is limited to 5 mA or less. For the G1201, once the input voltage exceeds the supply by more than 0.6V the input current quickly exceeds 5 mA. If this condition continues to exist, an external series resistor should be added. The size of the resistor is calculated by dividing the maximum overvoltage by 5 mA. For example, if the input voltage could reach 10V, the external resistor should be $(10V / 5mA) = 2k\Omega$. This resistance should be placed in series with either or both inputs if they are exposed to an overvoltage condition.

A Single-Supply Headphone Amplifier

Because of its speed and large output drive, the G1201 make an excellent headphone driver, as illustrated in Figure 2. Its low supply operation and rail-to-rail inputs and outputs give a maximum signal swing on a single +5V supply. To ensure maximum signal swing available to drive the headphone, the amplifier inputs are biased to $V+/2$, which in this case is 2.5V. The 100kΩ resistor to the positive supply is equally split into two 50 kΩ resistors, with their common point bypassed by 10μF to prevent power supply noise from contaminating the audio signal.

The audio signal is then ac-coupled to each input through a 10μF capacitor. A large value is needed to ensure that the 20Hz audio information is not blocked. If the input already has the proper dc bias, the ac coupling and biasing resistors are not required. A 270μF capacitor is used at the output to couple the amplifier to the headphone. This value is much larger than that used for the input because of the low impedance of the headphones, which can range from 32Ω to 600Ω. An additional 16Ω resistor is used in series with the output capacitor to protect the op amp's output stage by limiting capacitor discharge current. When driving a 32Ω load, the circuit exhibits less than 0.3% THD+N at output drive levels of 4.2 V_{P-P}.

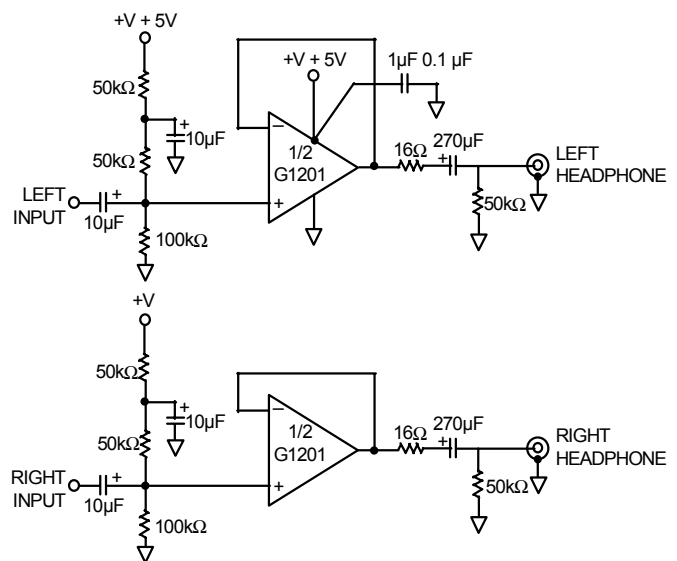
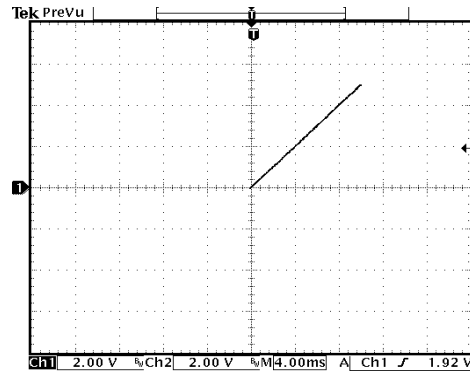
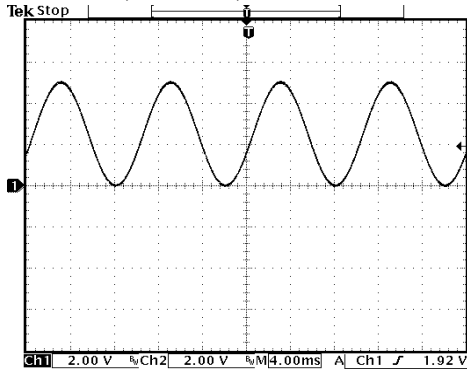

Figure 2. A Single-Supply, Stereo Headphone Driver

Input Common Mode Voltage Range Figure

Test Condition : $T_A = 25^\circ\text{C}$, $A_V = 1$

$V_+ = 5\text{V}$, $V_- = 0\text{V}$, $R_L = 2\text{K}\Omega$



$V_+ = 5\text{V}$, $V_- = 0\text{V}$, $R_L = 250\Omega$

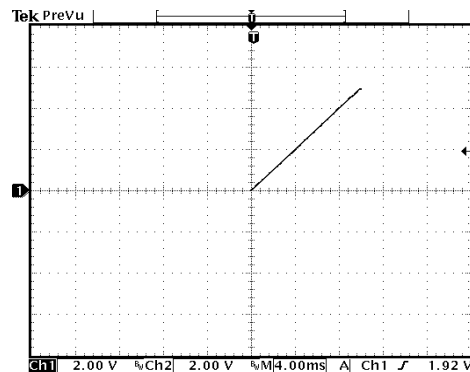
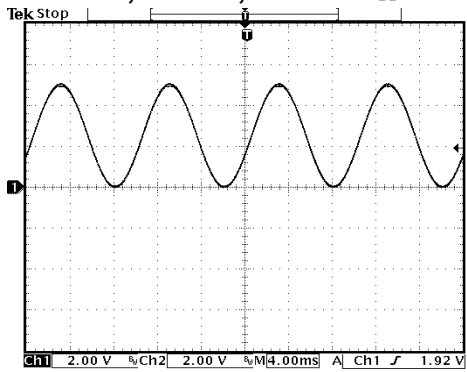

$V_+ = 3\text{V}$, $V_- = 0\text{V}$, $R_L = 2\text{K}\Omega$

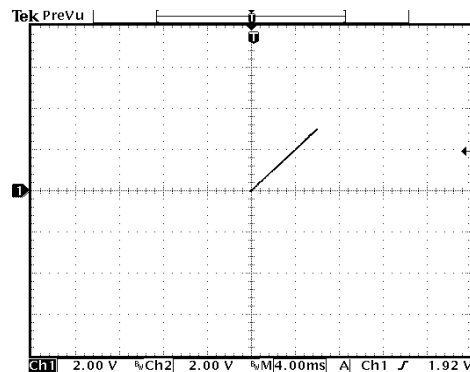
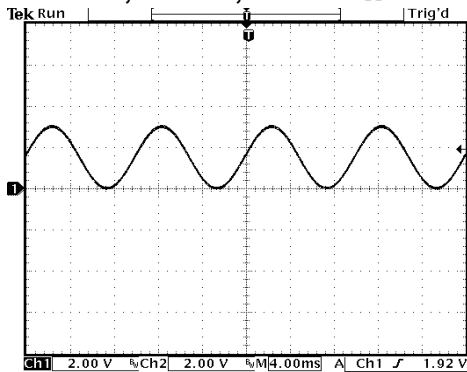

$V_+ = 3\text{V}$, $V_- = 0\text{V}$, $R_L = 250\Omega$

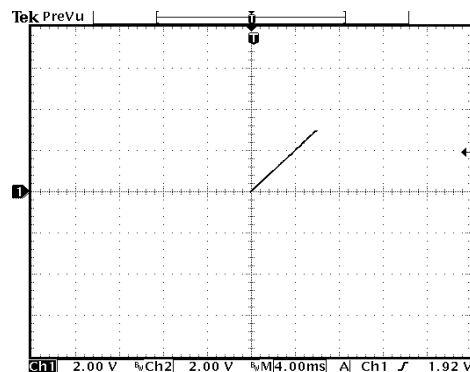
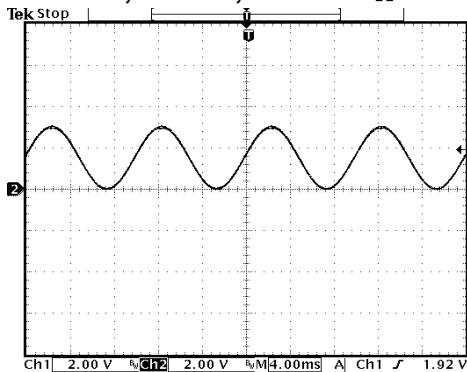

Output Swing Range Voltage Figure

Test Condition : TA=25°C, AV= -1

V+ = 2.5V , V- = - 2.5V , RL=2kΩ

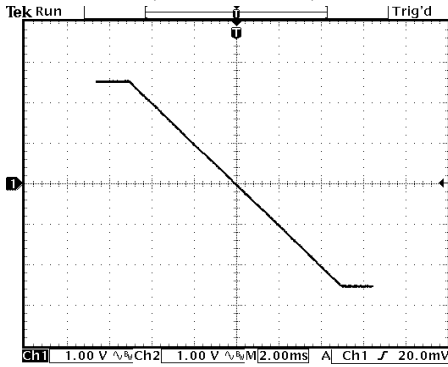

V+ = 1.5V , V- = - 1.5V , RL=2kΩ

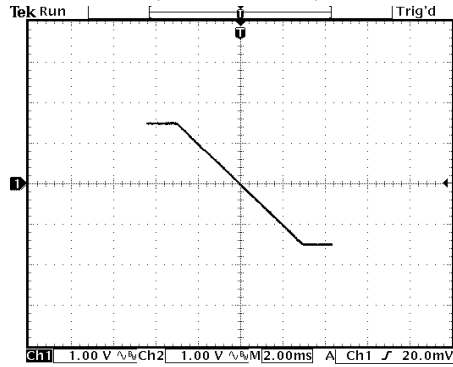

V+ = 2.5V , V- = - 2.5V , RL=250Ω

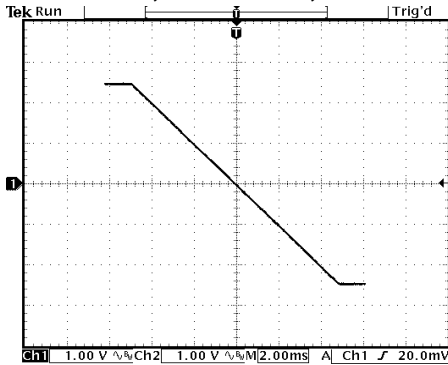

V+ = 1.5V , V- = - 1.5V , RL=250Ω

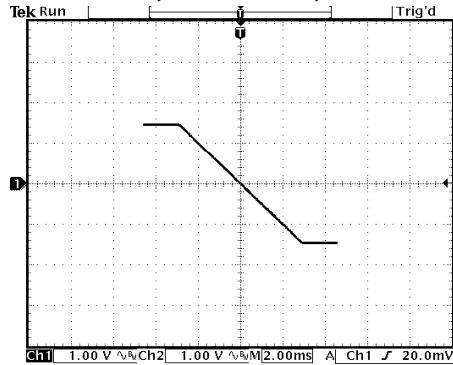

V+ = 2.5V , V- = - 2.5V , RL=32Ω

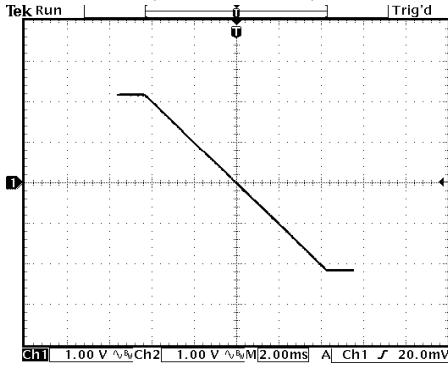

V+ = 1.5V , V- = - 1.5V , RL=32Ω

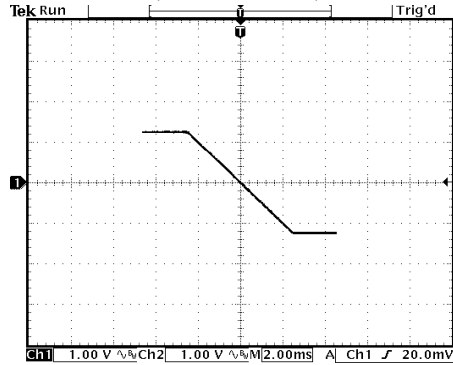

V+ = 2.5V , V- = - 2.5V , RL=16Ω

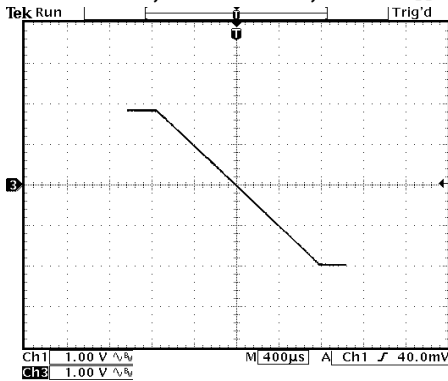

V+ = 1.5V , V- = - 1.5V , RL=16Ω

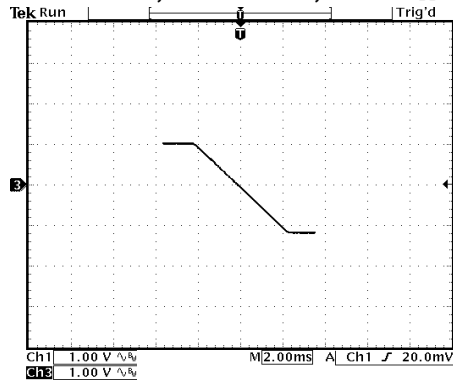

Large Signal Transient Response Figure

Test Condition : $T_A=25^{\circ}\text{C}$, $A_V=1$, $R_L = 2\text{k}\Omega$

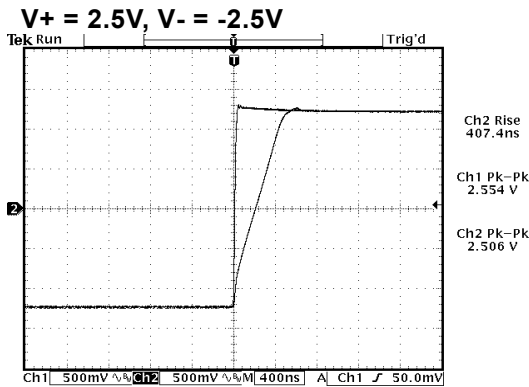

SR (rising) = $2.5\text{V}/408\text{ns} = 6.14\text{V}/\mu\text{s}$

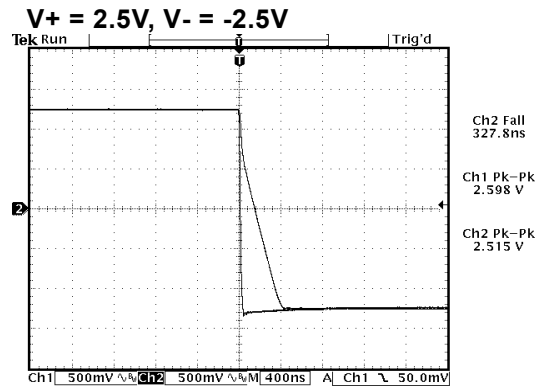

SR (falling) = $2.5\text{V}/327\text{ns} = 7.65\text{V}/\mu\text{s}$

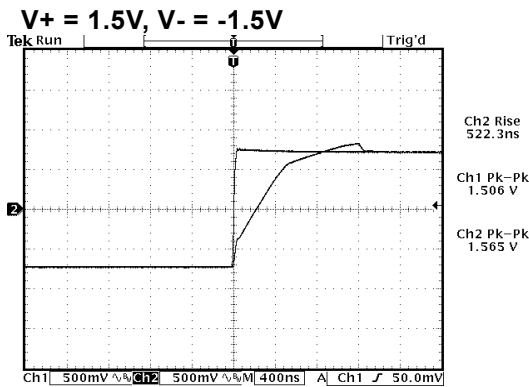

SR (rising) = $1.5\text{V}/522\text{ns} = 2.87\text{V}/\mu\text{s}$

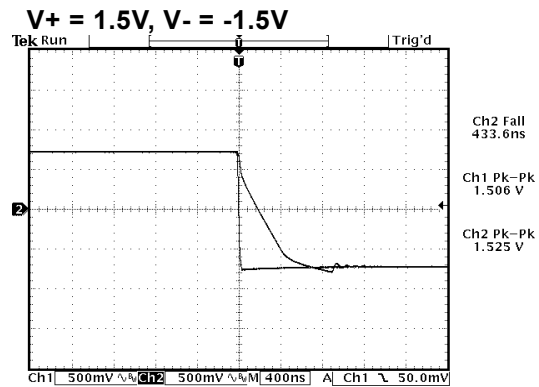

SR (falling) = $1.5\text{V}/434\text{ns} = 3.45\text{V}/\mu\text{s}$

Test Condition: $T_A=25^{\circ}\text{C}$, $V+ = 2.5\text{V}$, $V- = -2.5\text{V}$

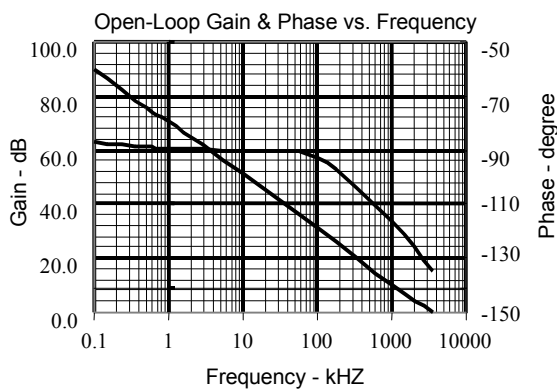

Test Condition: $T_A=25^{\circ}\text{C}$, $V+ = 2.5\text{V}$, $V- = -2.5\text{V}$

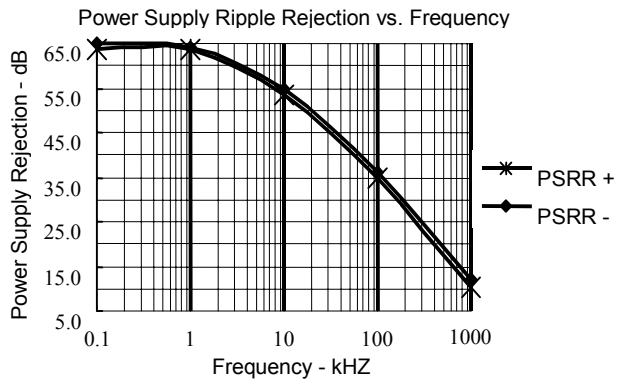

Package Information

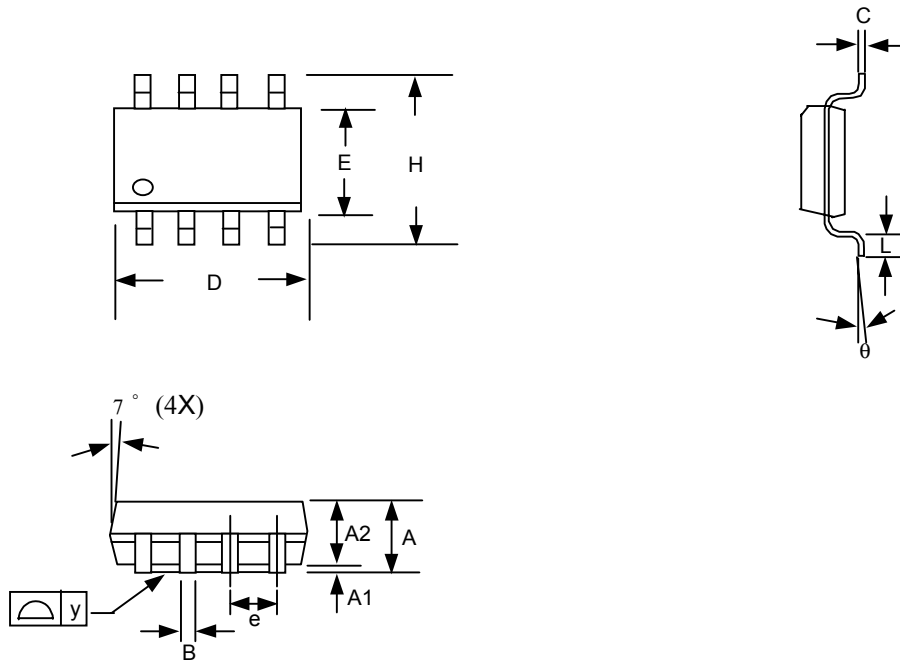

Note:

1. Package body sizes exclude mold flash and gate burrs
2. Dimension L is measured in gage plane
3. Tolerance 0.10mm unless otherwise specified
4. Controlling dimension is millimeter converted inch dimensions are not necessarily exact.

SYMBOL	DIMENSION IN MM			DIMENSION IN INCH		
	MIN.	NOM.	MAX.	MIN.	NOM.	MAX.
A	1.35	1.60	1.75	0.053	0.063	0.069
A1	0.10	----	0.25	0.004	----	0.010
A2	----	1.45	----	----	0.057	----
B	0.33	----	0.51	0.013	----	0.020
C	0.19	----	0.25	0.007	----	0.010
D	4.80	----	5.00	0.189	----	0.197
E	3.80	----	4.00	0.150	----	0.157
e	----	1.27	----	----	0.050	----
H	5.80	----	6.20	0.228	----	0.244
L	0.40	----	1.27	0.016	----	0.050
y	----	----	0.10	----	----	0.004
θ	0°	----	8°	0°	----	8°

Taping Specification

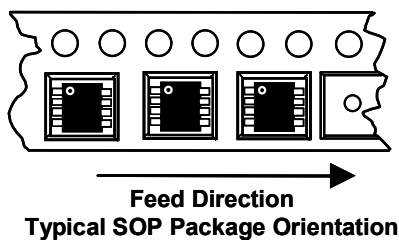

GMT Inc. does not assume any responsibility for use of any circuitry described, no circuit patent licenses are implied and GMT Inc. reserves the right at any time without notice to change said circuitry and specifications.