



**AO4701**

**P-Channel Enhancement Mode Field Effect Transistor  
with Schottky Diode**

**General Description**

The AO4701 uses advanced trench technology to provide excellent  $R_{DS(ON)}$  and low gate charge. A Schottky diode is provided to facilitate the implementation of a bidirectional blocking switch.

**Features**

- $V_{DS}$  (V) = -30V
- $I_D$  = -5A
- $R_{DS(ON)} < 49m\Omega$  ( $V_{GS} = 10V$ )
- $R_{DS(ON)} < 64m\Omega$  ( $V_{GS} = 4.5V$ )
- $R_{DS(ON)} < 120m\Omega$  ( $V_{GS} = 2.5V$ )

**SCHOTTKY**

$V_{DS}$  (V) = 30V,  $I_F = 3A$ ,  $V_F=0.5V@1A$

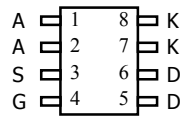

SOIC-8

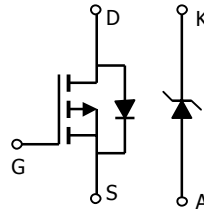

**Absolute Maximum Ratings  $T_A=25^\circ C$  unless otherwise noted**

Parameter	Symbol	MOSFET	Schottky	Units
Drain-Source Voltage	$V_{DS}$	-30		V
Gate-Source Voltage	$V_{GS}$	$\pm 12$		V
Continuous Drain Current <sup>A</sup>	$I_D$	$T_A=25^\circ C$	-5	A
		$T_A=70^\circ C$	-4.2	
Pulsed Drain Current <sup>B</sup>	$I_{DM}$	-30		
Schottky reverse voltage	$V_{KA}$		30	V
Continuous Forward Current <sup>A</sup>	$I_F$	$T_A=25^\circ C$	4.4	A
		$T_A=70^\circ C$	3.2	
Pulsed Forward Current <sup>B</sup>	$I_{FM}$		30	
Power Dissipation	$P_D$	$T_A=25^\circ C$	2	W
		$T_A=70^\circ C$	1.44	
Junction and Storage Temperature Range	$T_J, T_{STG}$	-55 to 150	-55 to 150	$^\circ C$

Parameter: Thermal Characteristics MOSFET		Symbol	Typ	Max	Units
Maximum Junction-to-Ambient <sup>A</sup>	$t \leq 10s$	$R_{\theta JA}$	48	62.5	$^\circ C/W$
Maximum Junction-to-Ambient <sup>A</sup>	Steady-State		74	110	
Maximum Junction-to-Lead <sup>C</sup>	Steady-State	$R_{\theta JL}$	35	40	
Thermal Characteristics Schottky					
Maximum Junction-to-Ambient <sup>A</sup>	$t \leq 10s$	$R_{\theta JA}$	49	62.5	$^\circ C/W$
Maximum Junction-to-Ambient <sup>A</sup>	Steady-State		72	110	
Maximum Junction-to-Lead <sup>C</sup>	Steady-State	$R_{\theta JL}$	37	42	

Electrical Characteristics ( $T_J=25^\circ\text{C}$  unless otherwise noted)

Symbol	Parameter	Conditions	Min	Typ	Max	Units
<b>STATIC PARAMETERS</b>						
$BV_{DSS}$	Drain-Source Breakdown Voltage	$I_D=-250\mu\text{A}$ , $V_{GS}=0\text{V}$	-30			V
$I_{DSS}$	Zero Gate Voltage Drain Current	$V_{DS}=-24\text{V}$ , $V_{GS}=0\text{V}$ $T_J=55^\circ\text{C}$			-1 -5	$\mu\text{A}$
$I_{GSS}$	Gate-Body leakage current	$V_{DS}=0\text{V}$ , $V_{GS}=\pm 12\text{V}$			$\pm 100$	nA
$V_{GS(th)}$	Gate Threshold Voltage	$V_{DS}=V_{GS}$ , $I_D=-250\mu\text{A}$	-0.7	-1	-1.3	V
$I_{D(ON)}$	On state drain current	$V_{GS}=-4.5\text{V}$ , $V_{DS}=-5\text{V}$	-25			A
$R_{DS(ON)}$	Static Drain-Source On-Resistance	$V_{GS}=-10\text{V}$ , $I_D=-5\text{A}$ $T_J=125^\circ\text{C}$		42.5	49	$\text{m}\Omega$
		$V_{GS}=-4.5\text{V}$ , $I_D=-4\text{A}$		54	64	$\text{m}\Omega$
		$V_{GS}=-2.5\text{V}$ , $I_D=-1\text{A}$		83	120	$\text{m}\Omega$
$g_{FS}$	Forward Transconductance	$V_{DS}=-5\text{V}$ , $I_D=-5\text{A}$	7	11		S
$V_{SD}$	Diode Forward Voltage	$I_S=-1\text{A}$ , $V_{GS}=0\text{V}$		-0.75	-1	V
$I_S$	Maximum Body-Diode Continuous Current				-3	A
<b>DYNAMIC PARAMETERS</b>						
$C_{iss}$	Input Capacitance	$V_{GS}=0\text{V}$ , $V_{DS}=-15\text{V}$ , $f=1\text{MHz}$		952		pF
$C_{oss}$	Output Capacitance			103		pF
$C_{rSS}$	Reverse Transfer Capacitance			77		pF
$R_g$	Gate resistance	$V_{GS}=0\text{V}$ , $V_{DS}=0\text{V}$ , $f=1\text{MHz}$		5.9		$\Omega$
<b>SWITCHING PARAMETERS</b>						
$Q_g$	Total Gate Charge	$V_{GS}=-4.5\text{V}$ , $V_{DS}=-15\text{V}$ , $I_D=-4\text{A}$		9.5		nC
$Q_{gs}$	Gate Source Charge			2		nC
$Q_{gd}$	Gate Drain Charge			3.1		nC
$t_{D(on)}$	Turn-On Delay Time	$V_{GS}=-10\text{V}$ , $V_{DS}=-15\text{V}$ , $R_L=3.6\Omega$ , $R_{GEN}=6\Omega$		12		ns
$t_r$	Turn-On Rise Time			4		ns
$t_{D(off)}$	Turn-Off Delay Time			37		ns
$t_f$	Turn-Off Fall Time			12		ns
$t_{rr}$	Body Diode Reverse Recovery Time	$I_F=-5\text{A}$ , $dI/dt=100\text{A}/\mu\text{s}$		21		ns
$Q_{rr}$	Body Diode Reverse Recovery Charge	$I_F=-5\text{A}$ , $dI/dt=100\text{A}/\mu\text{s}$		13		nC
<b>SCHOTTKY PARAMETERS</b>						
$V_F$	Forward Voltage Drop	$I_F=1.0\text{A}$		0.45	0.5	V
$I_{rm}$	Maximum reverse leakage current	$V_R=30\text{V}$		0.007	0.05	mA
		$V_R=30\text{V}$ , $T_J=125^\circ\text{C}$		3.2	10	
		$V_R=30\text{V}$ , $T_J=150^\circ\text{C}$		12	20	
$C_T$	Junction Capacitance	$V_R=15\text{V}$		37		pF

A: The value of  $R_{\theta JA}$  is measured with the device mounted on 1in<sup>2</sup> FR-4 board with 2oz. Copper, in a still air environment with  $T_A=25^\circ\text{C}$ . The value in any a given application depends on the user's specific board design. The current rating is based on the  $t \leq 10\text{s}$  thermal resistance rating.

B: Repetitive rating, pulse width limited by junction temperature.

C. The  $R_{\theta JA}$  is the sum of the thermal impedance from junction to lead  $R_{\theta JL}$  and lead to ambient.

D. The static characteristics in Figures 1 to 6,12,14 are obtained using 80 $\mu\text{s}$  pulses, duty cycle 0.5% max.

E. These tests are performed with the device mounted on 1 in<sup>2</sup> FR-4 board with 2oz. Copper, in a still air environment with  $T_A=25^\circ\text{C}$ . The

TYPICAL ELECTRICAL AND THERMAL CHARACTERISTICS

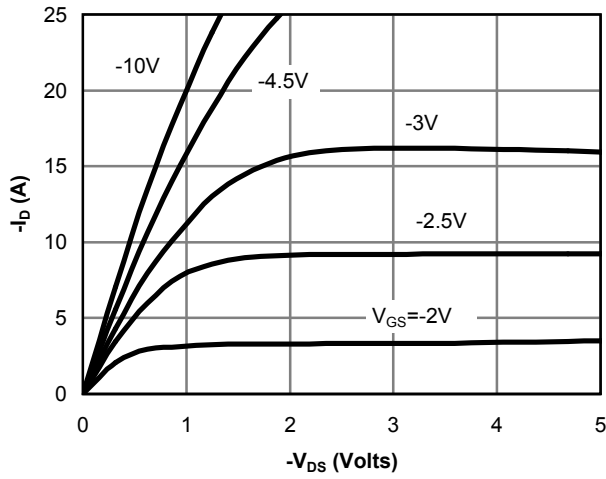

Fig 1: On-Region Characteristics

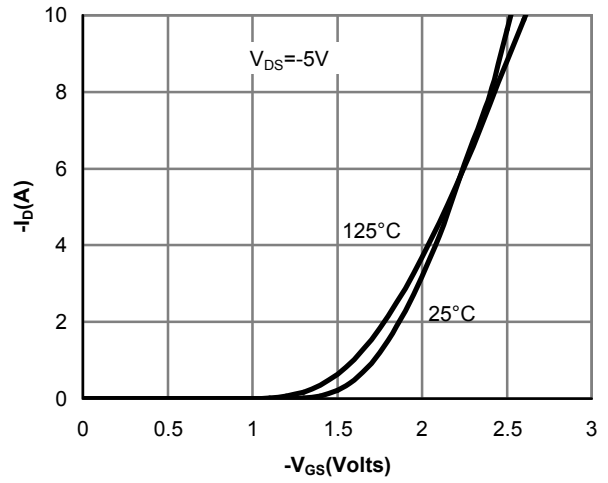

Figure 2: Transfer Characteristics

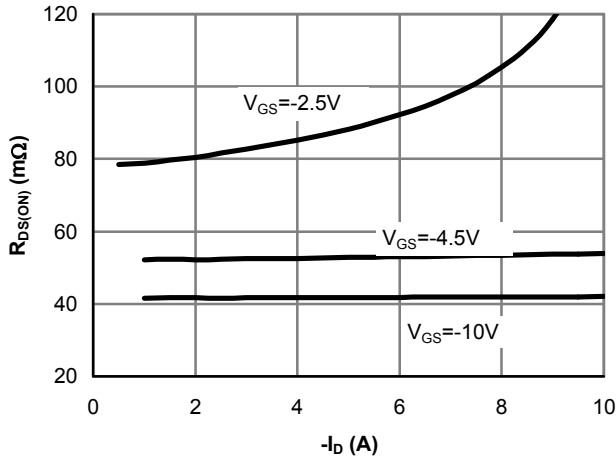

Figure 3: On-Resistance vs. Drain Current and Gate Voltage

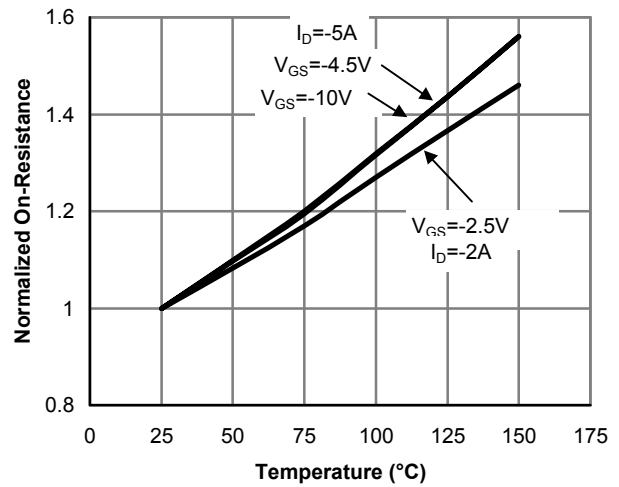

Figure 4: On-Resistance vs. Junction Temperature

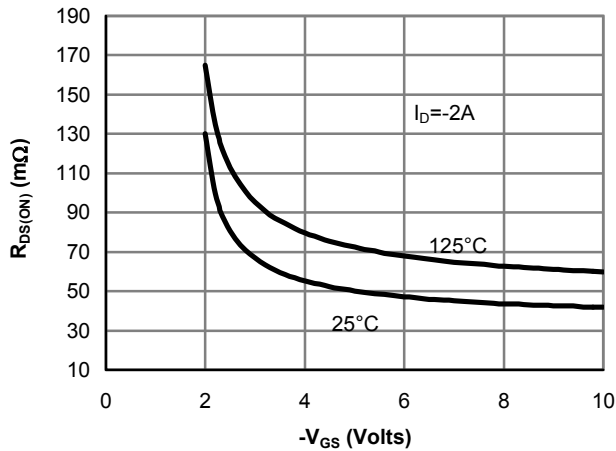

Figure 5: On-Resistance vs. Gate-Source Voltage

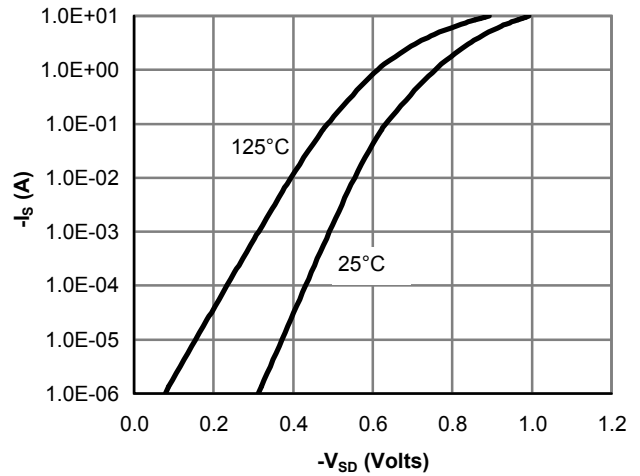

Figure 6: Body-Diode Characteristics

**AO4701**

---



i 3

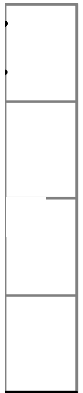

50 175

perature

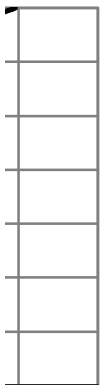

1.0 1.2

stics

TYPICAL ELECTRICAL AND THERMAL CHARACTERISTICS

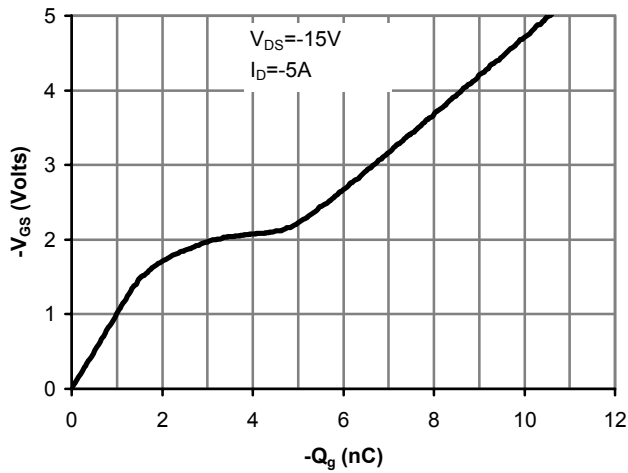

Figure 7: Gate-Charge Characteristics

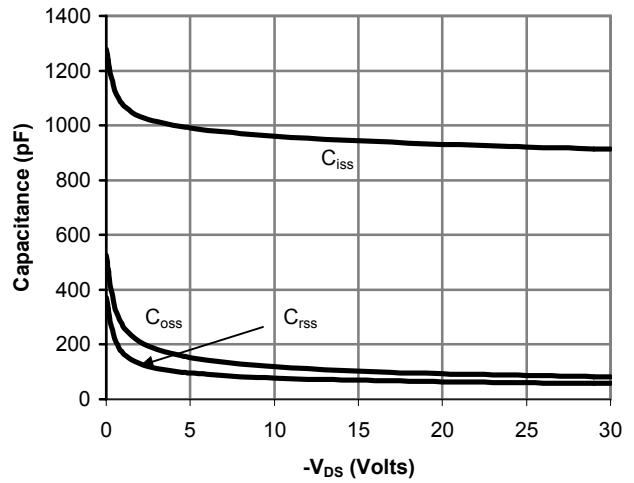

Figure 8: Capacitance Characteristics

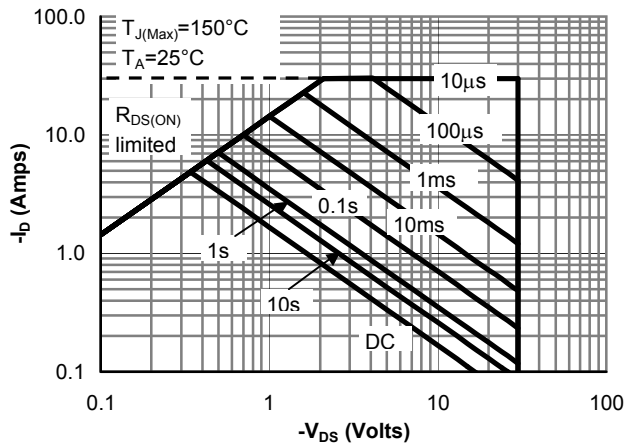

Figure 9: Maximum Forward Biased Safe Operating Area (Note E)

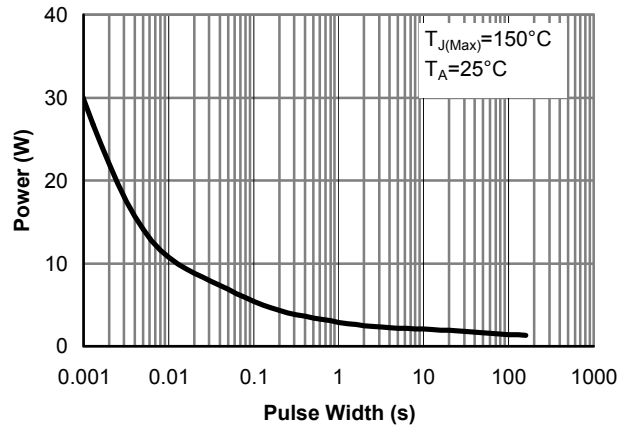

Figure 10: Single Pulse Power Rating Junction-to-Ambient (Note E)

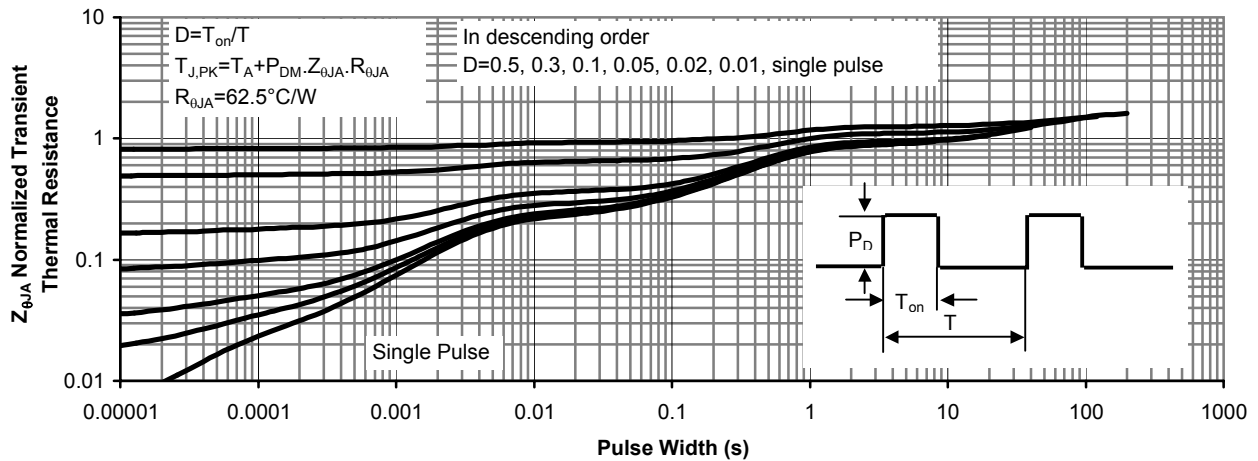

Figure 11: Normalized Maximum Transient Thermal Impedance

TYPICAL ELECTRICAL AND THERMAL CHARACTERISTICS: SCHOTTKY

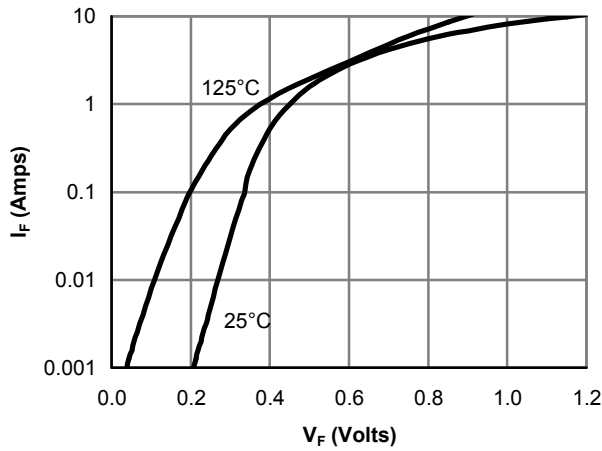

Figure 12: Schottky Forward Characteristics

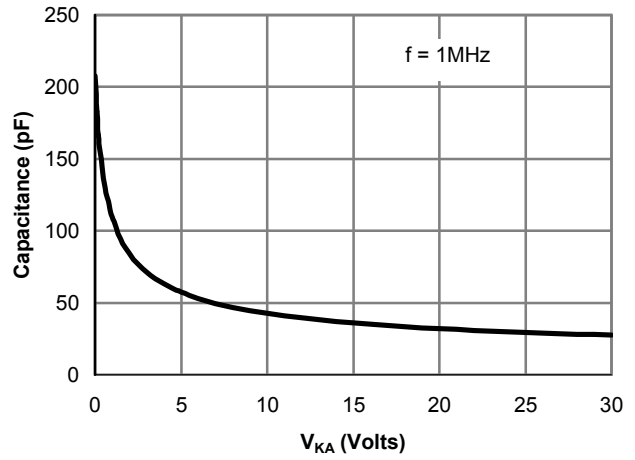

Figure 13: Schottky Capacitance Characteristics

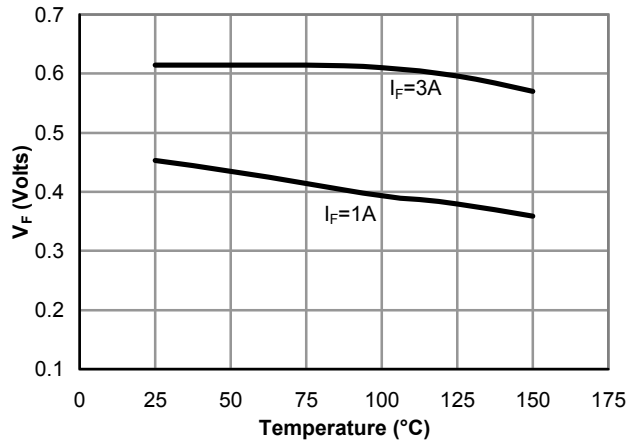

Figure 14: Schottky Forward Drop vs. Junction Temperature

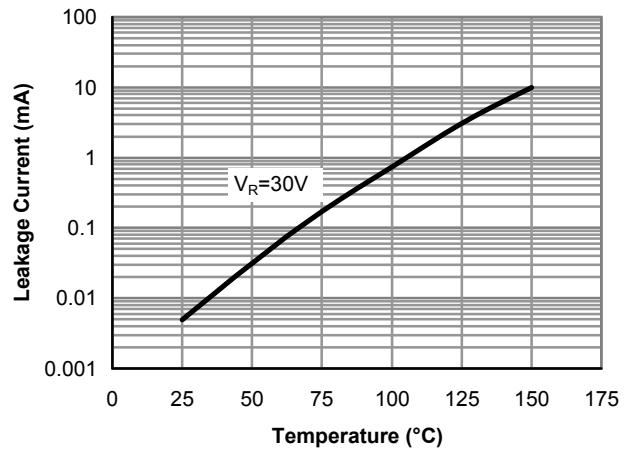

Figure 15: Schottky Leakage current vs. Junction Temperature

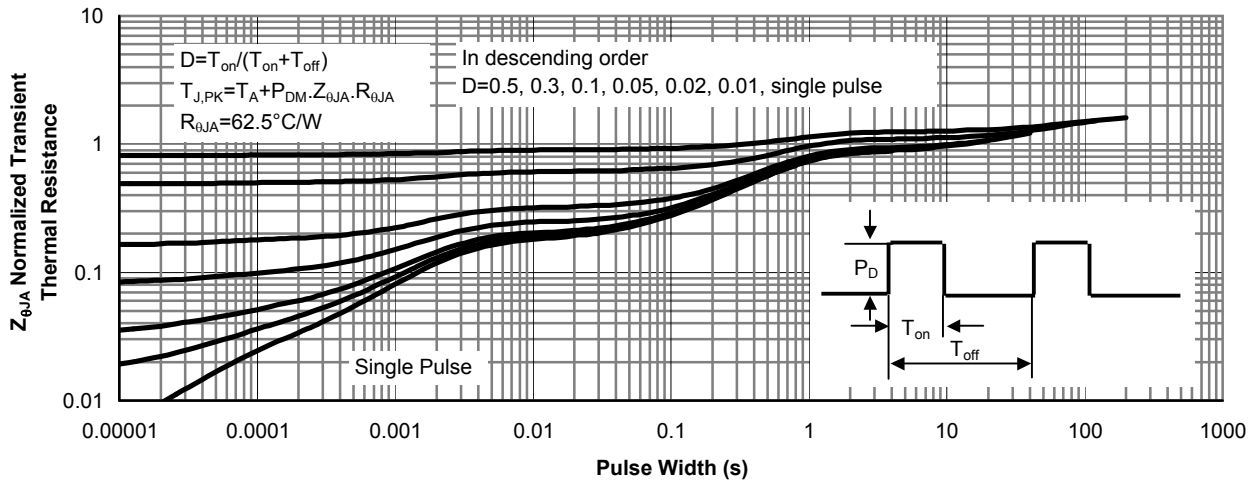
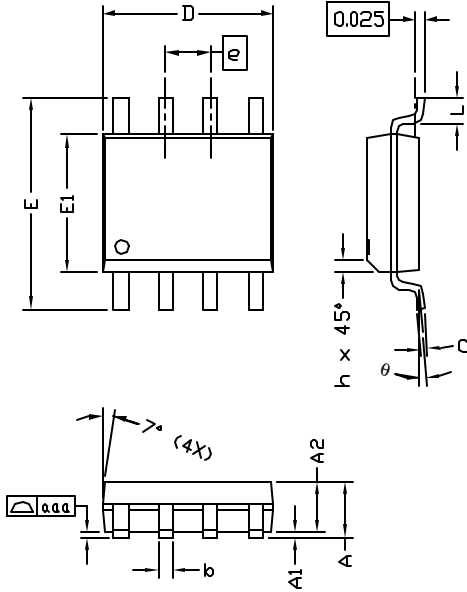

Figure 15: Schottky Normalized Maximum Transient Thermal Impedance



**ALPHA & OMEGA**  
SEMICONDUCTOR, INC.

## SO-8 Package Data



SYMBOLS	DIMENSIONS IN MILLIMETERS			DIMENSIONS IN INCHES		
	MIN	NOM	MAX	MIN	NOM	MAX
A	1.45	1.50	1.55	0.057	0.059	0.061
A1	0.00	—	0.10	0.000	—	0.004
A2	—	1.45	—	—	0.057	—
b	0.33	—	0.51	0.013	—	0.020
c	0.19	—	0.25	0.007	—	0.010
D	4.80	—	5.00	0.189	—	0.197
E1	3.80	—	4.00	0.150	—	0.157
e	1.27 BSC			0.050 BSC		
E	5.80	—	6.20	0.228	—	0.244
h	0.25	—	0.50	0.010	—	0.020
L	0.40	—	1.27	0.016	—	0.050
aaa	—	—	0.10	—	—	0.004
θ	0°	—	8°	0°	—	8°

- NOTE:
- LEAD FINISH: 150 MICROINCHES ( 3.8 um) MIN. THICKNESS OF Tin/Lead (SOLDER) PLATED ON LEAD
  - TOLERANCE ±0.10 mm (4 mil) UNLESS OTHERWISE SPECIFIED
  - COPLANARITY : 0.10 mm
  - DIMENSION L IS MEASURED IN GAGE PLANE

### PACKAGE MARKING DESCRIPTION

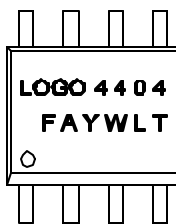

- NOTE:
- LOGO - AOS LOGO
  - 4701 - PART NUMBER CODE.
  - F - FAB LOCATION
  - A - ASSEMBLY LOCATION
  - Y - YEAR CODE
  - W - WEEK CODE
  - L N - ASSEMBLY LOT CODE

### SO-8 PART NO. CODE

PART NO.	CODE
AO4701	4701

### RECOMMENDED LAND PATTERN

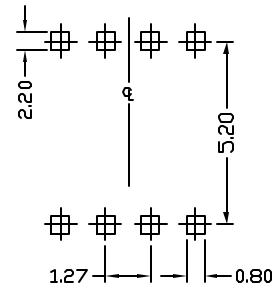

UNIT: mm



SO-8 Carrier Tape

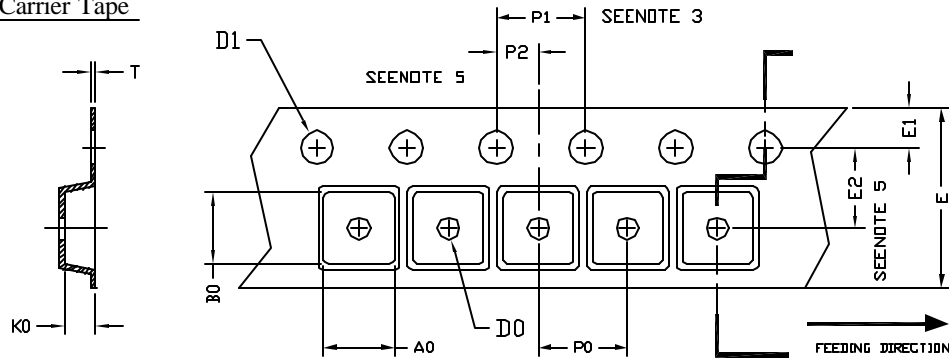

UNIT: MM

PACKAGE	A0	B0	K0	D0	D1	E	E1	E2	P0	P1	P2	T
SO-8 (12 mm)	6.40 ±0.10	5.20 ±0.10	2.10 ±0.10	1.60 ±0.10	1.30 ±0.10	12.00 ±0.30	1.75 ±0.10	5.50 ±0.05	8.00 ±0.10	4.00 ±0.10	2.00 ±0.05	0.25 ±0.05

SO-8 Reel

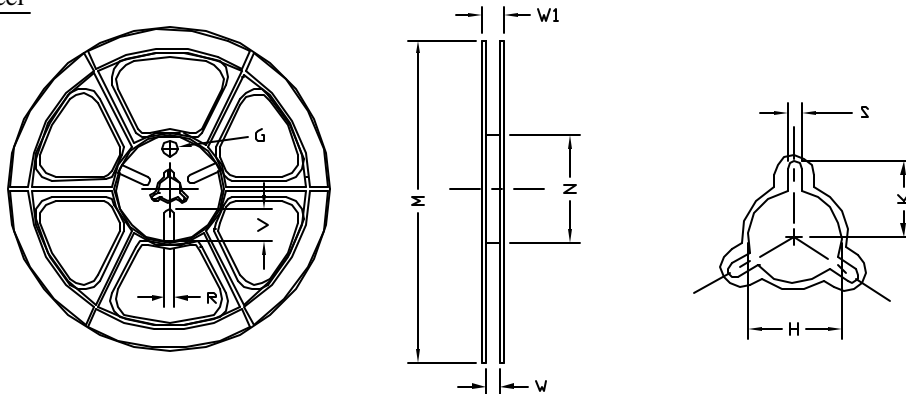

UNIT: MM

TAPE SIZE	REEL SIZE	M	N	W	W1	H	K	S	G	R	V
12 mm	φ330	φ330.00 ±0.50	φ97.00 ±0.10	13.00 ±0.30	17.40 ±1.00	φ13.00 +0.50 -0.20	10.60	2.00 ±0.50	---	---	---

SO-8 Tape

Leader / Trailer  
& Orientation

