



Major Ratings and Characteristics

| Characteristics | 6CWQ04FN | Units |
|--|------------|------------|
| $I_{F(AV)}$ Rectangular waveform | 7 | A |
| V_{RRM} | 40 | V |
| I_{FSM} @ $t_p=5\mu s$ sine | 500 | A |
| V_F @ 3 Apk, $T_J = 125^\circ C$ (per leg) | 0.49 | V |
| T_J range | -40 to 150 | $^\circ C$ |

Description/ Features

The 6CWQ04FN surface mount, center tap, Schottky rectifier series has been designed for applications requiring low forward drop and small foot prints on PC board. Typical applications are in disk drives, switching power supplies, converters, free-wheeling diodes, battery charging, and reverse battery protection.

- Popular D-PAK outline
- Center tap configuration
- Small foot print, surface mountable
- Low forward voltage drop
- High frequency operation
- Guard ring for enhanced ruggedness and long term reliability

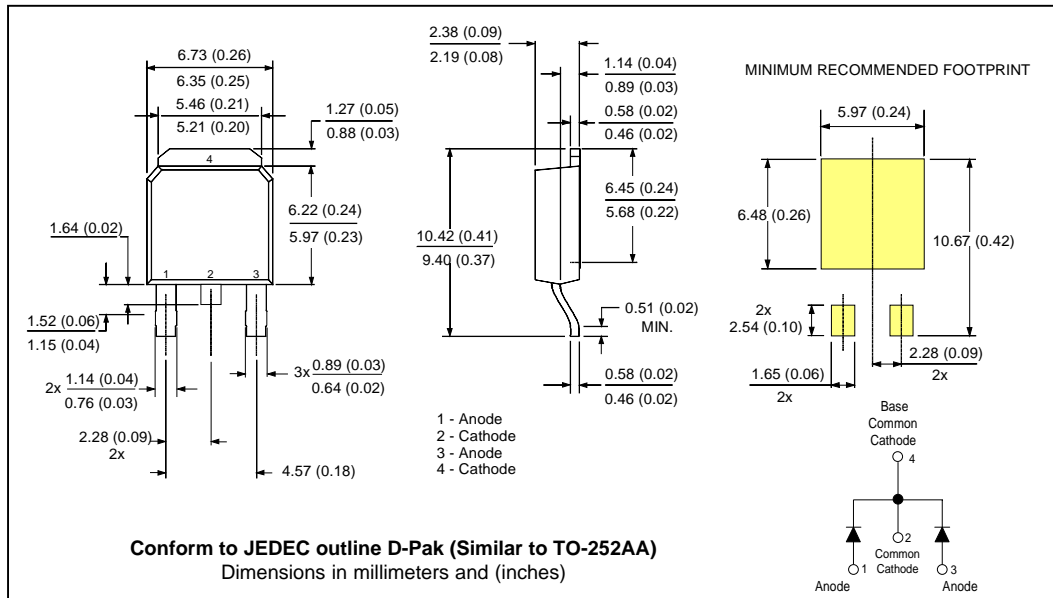

Voltage Ratings

| Part number | 6CWQ04FN |
|---|----------|
| V_R Max. DC Reverse Voltage (V) | 40 |
| V_{RWM} Max. Working Peak Reverse Voltage (V) | |

Absolute Maximum Ratings

| Parameters | 6CWQ... | Units | Conditions |
|--|-----------|-------|--|
| $I_{F(AV)}$ Max. Average Forward (Per Leg) Current * See Fig. 5 (Per Device) | 3.5 7 | A | 50% duty cycle @ $T_C = 135^\circ\text{C}$, rectangular wave form |
| I_{FSM} Max. Peak One Cycle Non-Repetitive Surge Current (Per Leg) * See Fig. 7 | 500 80 | A | 5 μs Sine or 3 μs Rect. pulse 10ms Sine or 6ms Rect. pulse Following any rated load condition and with rated V_{RWM} applied |
| E_{AS} Non-Repet. Avalan. Energy (Per Leg) | 8.0 | mJ | $T_J = 25^\circ\text{C}$, $I_{AS} = 1$ Amp, $L = 16$ mH |
| I_{AR} Repetitive Avalanche Current (Per Leg) | 1.0 | A | Current decaying linearly to zero in 1 μsec Frequency limited by T_J max. $V_A = 1.5 \times V_R$ typical |

Electrical Specifications

| Parameters | 6CWQ... | Units | Conditions |
|--|---------|------------------|---|
| V_{FM} Max. Forward Voltage Drop (Per Leg) * See Fig. 1 (1) | 0.53 | V | @ 3A $T_J = 25^\circ\text{C}$ |
| | 0.67 | V | @ 6A |
| | 0.49 | V | @ 3A $T_J = 125^\circ\text{C}$ |
| | 0.62 | V | @ 6A |
| I_{RM} Max. Reverse Leakage Current (Per Leg) * See Fig. 2 (1) | 2 | mA | $T_J = 25^\circ\text{C}$ |
| | 24 | mA | $T_J = 125^\circ\text{C}$ $V_R = \text{rated } V_R$ |
| $V_{F(TO)}$ Threshold Voltage | 0.34 | V | $T_J = T_J \text{ max.}$ |
| r_t Forward Slope Resistance | 37.33 | m Ω | |
| C_T Typ. Junction Capacitance (Per Leg) | 189 | pF | $V_R = 5V_{DC}$, (test signal range 100Khz to 1Mhz) 25°C |
| L_S Typical Series Inductance (Per Leg) | 5.0 | nH | Measured lead to lead 5mm from package body |
| dv/dt Max. Voltage Rate of Change | 10000 | V/ μs | (Rated V_R) |

(1) Pulse Width < 300 μs , Duty Cycle <2%

Thermal-Mechanical Specifications

| Parameters | 6CWQ... | Units | Conditions |
|---|------------|--------------------|---------------------------|
| T_J Max. Junction Temperature Range (*) | -40 to 150 | $^\circ\text{C}$ | |
| T_{stg} Max. Storage Temperature Range | -40 to 150 | $^\circ\text{C}$ | |
| R_{thJC} Max. Thermal Resistance (Per Leg) Junction to Case (Per Device) | 4.70 | $^\circ\text{C/W}$ | DC operation * See Fig. 4 |
| | 2.35 | | |
| wt Approximate Weight | 0.3 (0.01) | g (oz.) | |
| Case Style | D-Pak | | Similar to TO-252AA |

(*) $\frac{dP_{tot}}{dT_J} < \frac{1}{R_{th(j-a)}}$ thermal runaway condition for a diode on its own heatsink

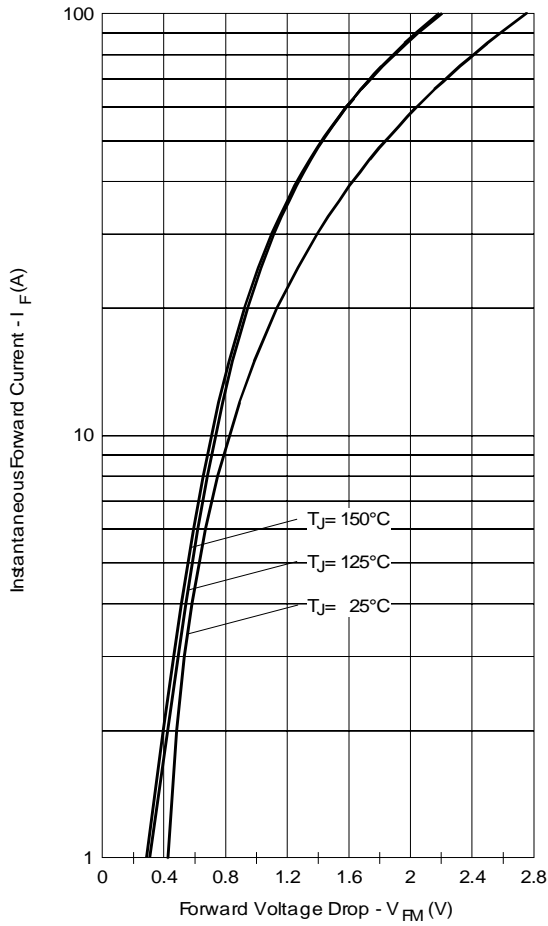

Fig. 1 - Max. Forward Voltage Drop Characteristics (Per Leg)

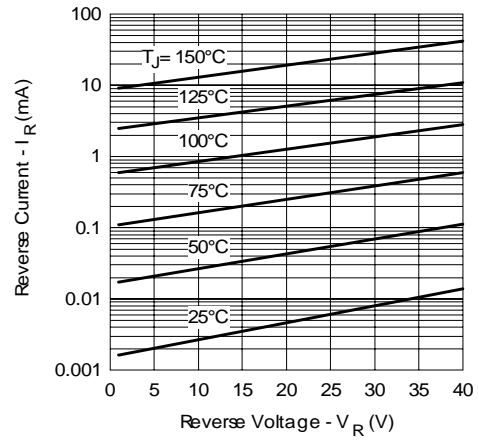

Fig. 2 - Typical Values Of Reverse Current Vs. Reverse Voltage (Per Leg)

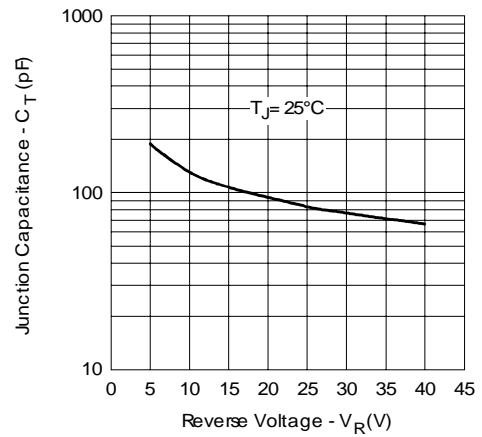

Fig. 3 - Typical Junction Capacitance Vs. Reverse Voltage (Per Leg)

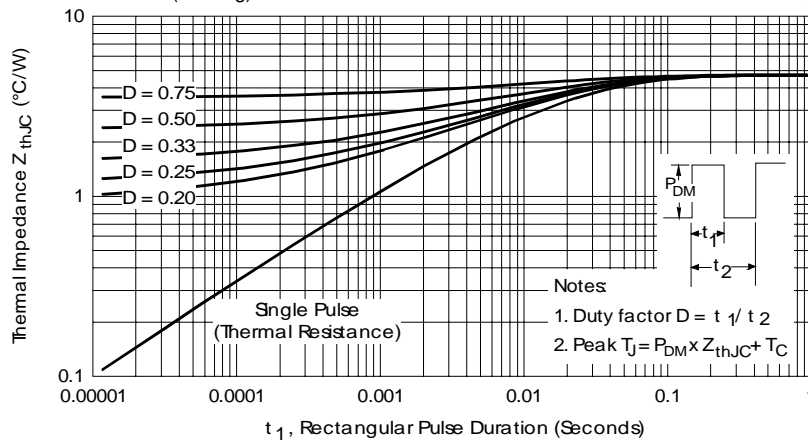

Fig. 4 - Max. Thermal Impedance Z_{thJC} Characteristics (Per Leg)

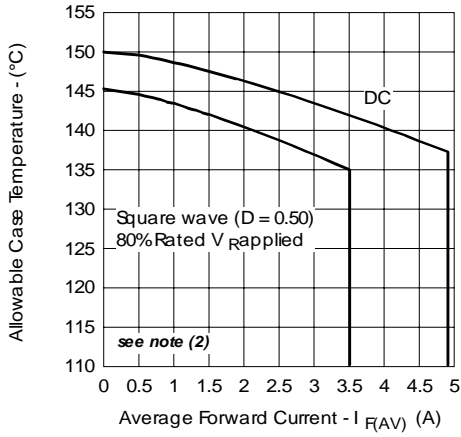

Fig. 5 - Max. Allowable Case Temperature Vs. Average Forward Current (Per Leg)

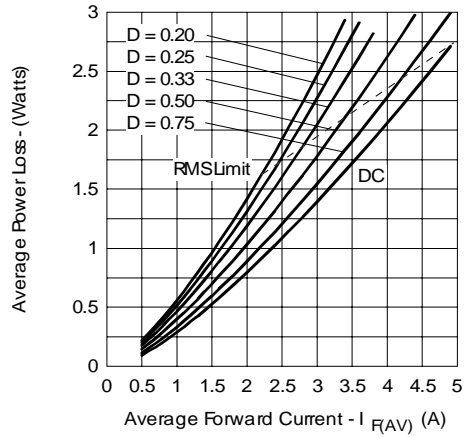

Fig. 6 - Forward Power Loss Characteristics (Per Leg)

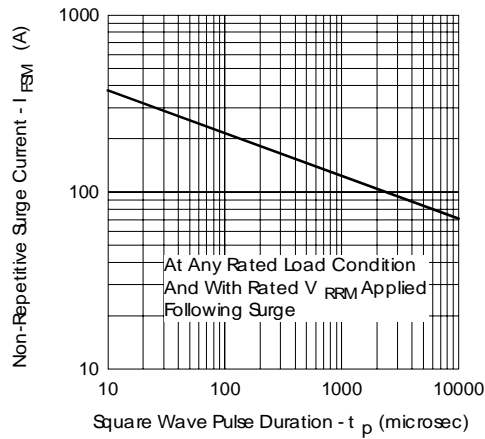

Fig. 7 - Max. Non-Repetitive Surge Current (Per Leg)

- (2) Formula used: $T_C = T_J - (Pd + Pd_{REV}) \times R_{thJC}$;
 $Pd = \text{Forward Power Loss} = I_{F(AV)} \times V_{FM} @ (I_{F(AV)}/D)$ (see Fig. 6);
 $Pd_{REV} = \text{Inverse Power Loss} = V_{R1} \times I_R (1 - D); I_R @ V_{R1} = 80\% \text{ rated } V_R$

6CWQ04FN

Bulletin PD-20527 rev. F 03/03

International
IOR Rectifier

Data and specifications subject to change without notice.
This product has been designed and qualified for Industrial Level.
Qualification Standards can be found on IR's Web site.

International
IOR Rectifier

IR WORLD HEADQUARTERS: 233 Kansas St., El Segundo, California 90245, USA Tel: (310) 252-7105
TAC Fax: (310) 252-7309
Visit us at www.irf.com for sales contact information. 03/03