

## 9GHz Frequency Divider by 4 Fixed Modulus Prescaler

### GaAs Monolithic Microwave IC

#### Description

The CND2047 is a low power consumption very high speed divider by 4 GaAs prescaler manufactured with a 0.7 $\mu$ m self aligned implanted MESFET process. The design is full differential input/output that allows direct drive into 50 $\Omega$  load.

The CND2047 is available in a low cost SOIC8 RoHS compliant plastic package.

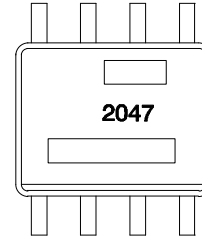

SOIC8 plastic package

#### Main Features

- Very broad operating frequency range
- Low power dissipation: 300mW
- Single supply operation: 3V to 5V
- Low phase noise: -139dBc/Hz at 1KHz

#### Main Characteristics

Tamb= +25 $^{\circ}$ C

Symbol	Parameter	Min	Typ	Max	Unit
Vdd	Drain voltage	3	5	6	V
Pdiss	Power dissipation	120	300	400	mW
Fmax	Maximum input frequency	8	9		GHz

ESD Protections: Electrostatic discharge sensitive device observe handling precautions!

## Electrical Characteristics in SOIC8 package

Guaranteed electrical specifications over the temperature range of -40°C to +85°C but tested at Tamb=25°C under configuration described in Fig.1 (Vdd=5V; Differential inputs; Pin=0dBm; Zo=50 Ω)

Symbol	Parameter	Min	Typ	Max	Unit
Fmax	Maximum input frequency	8.5	9		GHz
Idd	Supply current		60	75	mA

Typical design information over the temperature range of -40°C to +85°C (Vdd=5, Zo=50 Ω)

Symbol	Parameter	Min	Typ	Max	Unit
Fmax	Maximum input frequency				
	Differential input Pin= -5dBm	8	8.5		GHz
	Pin= 0dBm	8.5	9		GHz
	Single input Pin= -5dBm	7.25	7.75		GHz
	Pin= 0dBm	7.75	8.25		GHz
Pout	Output power	-4	-1.5		dBm
Idd	Supply current		60	75	mA

Typical design information over the temperature range of -40°C to +85°C. (Vdd=3.3V, Zo=50 Ω)

Symbol	Parameter	Min	Typ	Max	Unit
Fmax	Maximum input frequency				
	Differential input Pin= -5dBm	7	7.5		GHz
	Pin= 0dBm	7.5	8		GHz
	Single input Pin= -5dBm	6.5	7		GHz
	Pin= 0dBm	6.75	7.25		GHz
Pout	Output power	-7	-4.5		dBm
Idd	Supply current		40	55	mA

**Absolute Maximum Ratings (1)**

Tamb= 25°C

Symbol	Parameter	Values	Units
Vdd	Drain voltage	7	V
Pin	Maximum input power	15	dBm
Top	Operating temperature range	-40 to +85	°C
Tstg	Storage temperature range	-65 to +175	°C

(1) Operation of this device above anyone of these parameters may cause permanent damage

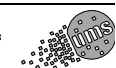

Typical Characteristics

Tamb= 25°C, Zo=50 Ω, Vdd=5V

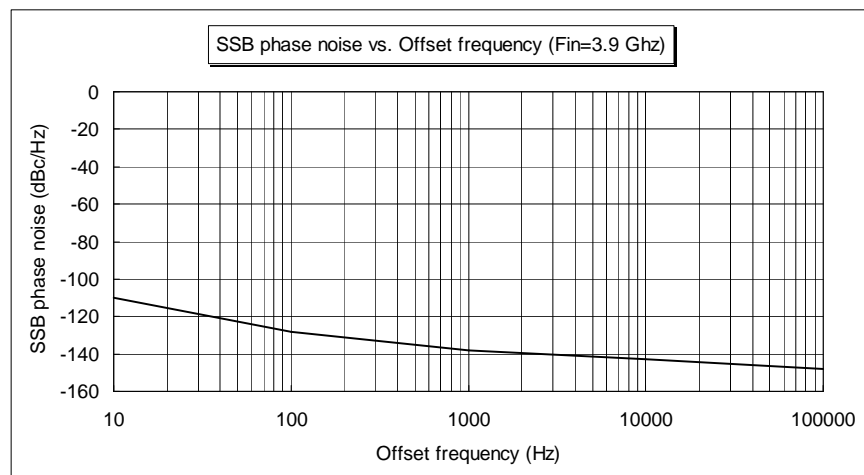
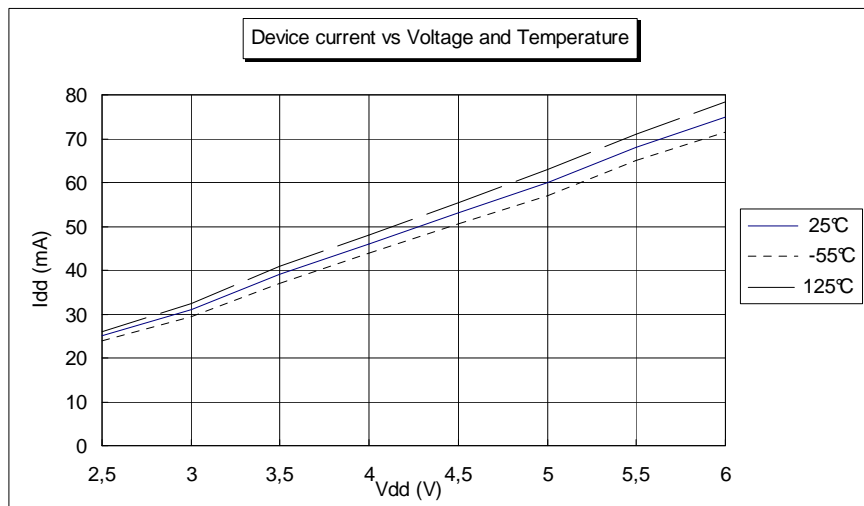
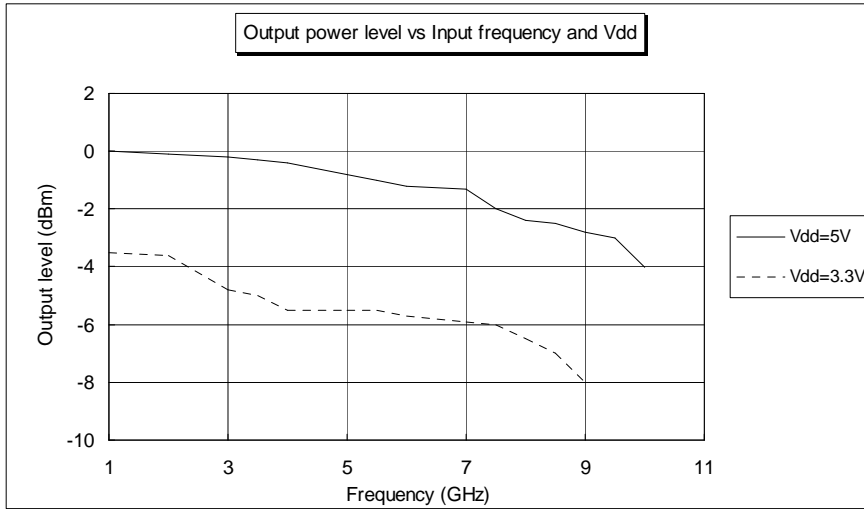

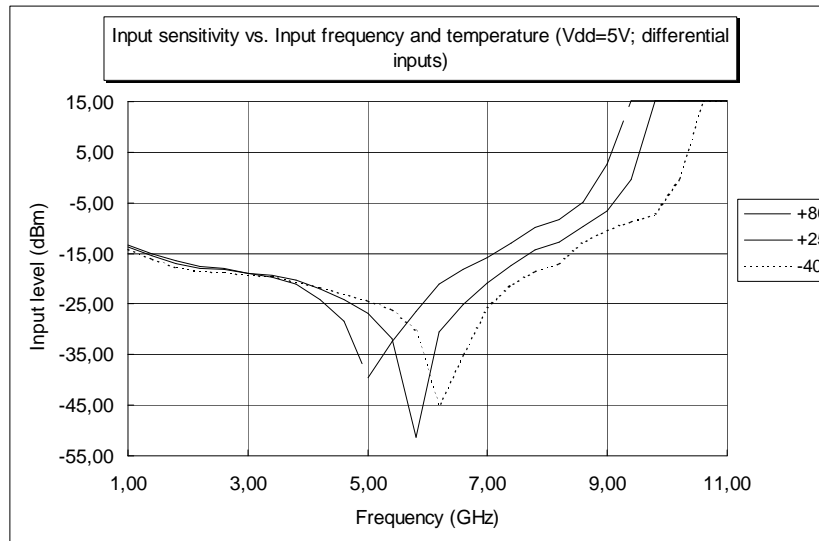

**SOIC8 package**

Typical bias tuning

T<sub>amb</sub>=25°C

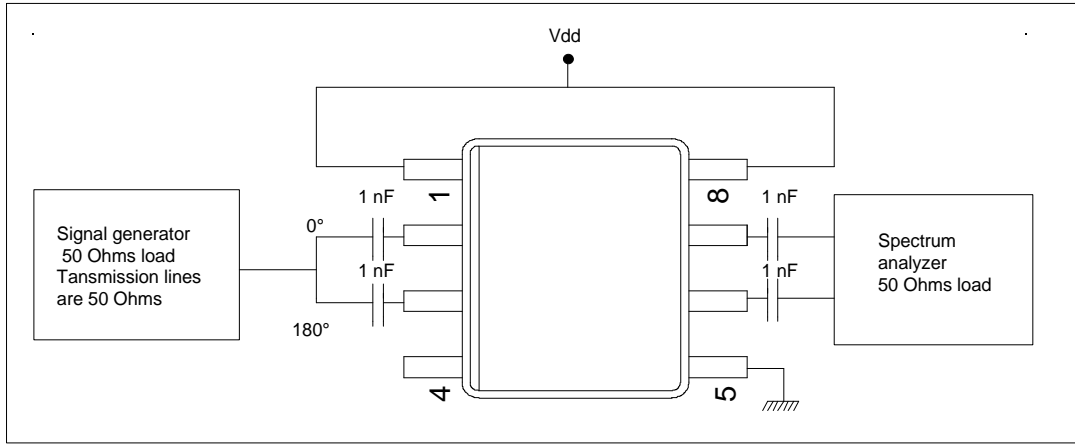

Fig.1: Typical measurement and RF biasing configuration (Differential inputs)

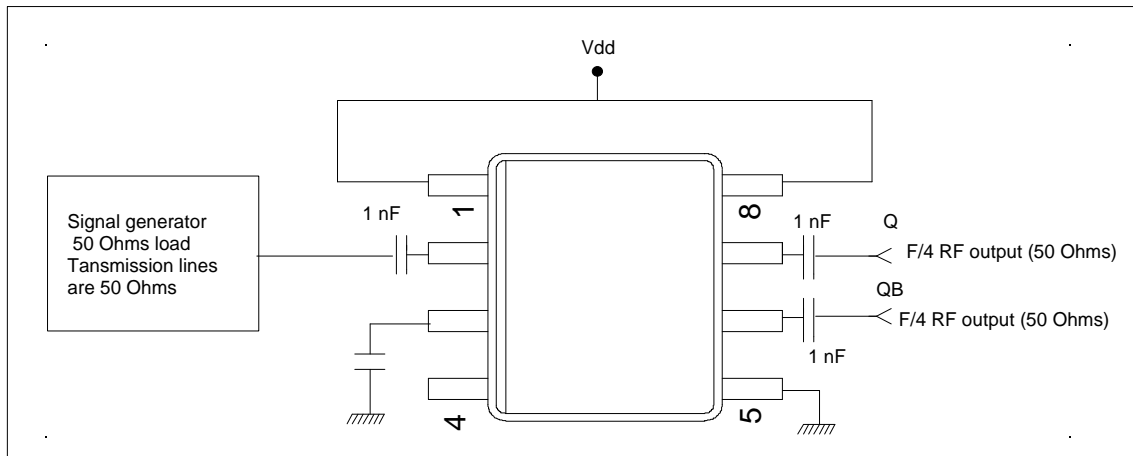

Fig.2: RF biasing configuration with single input

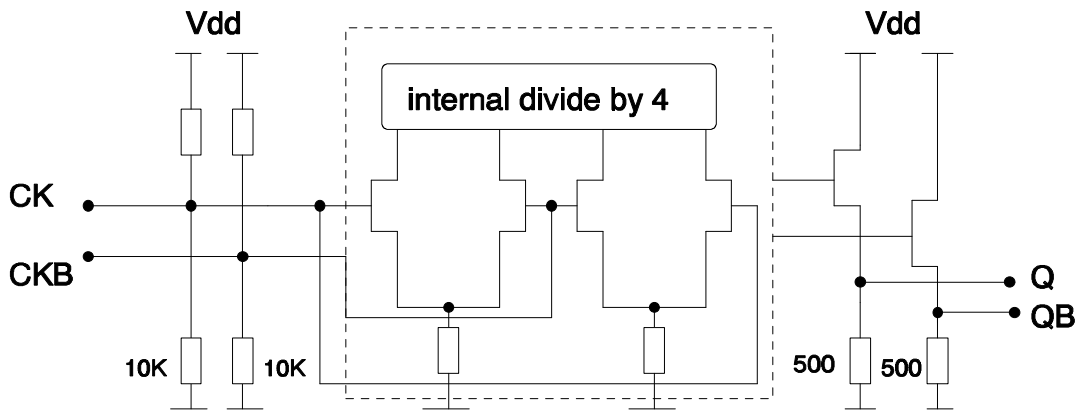
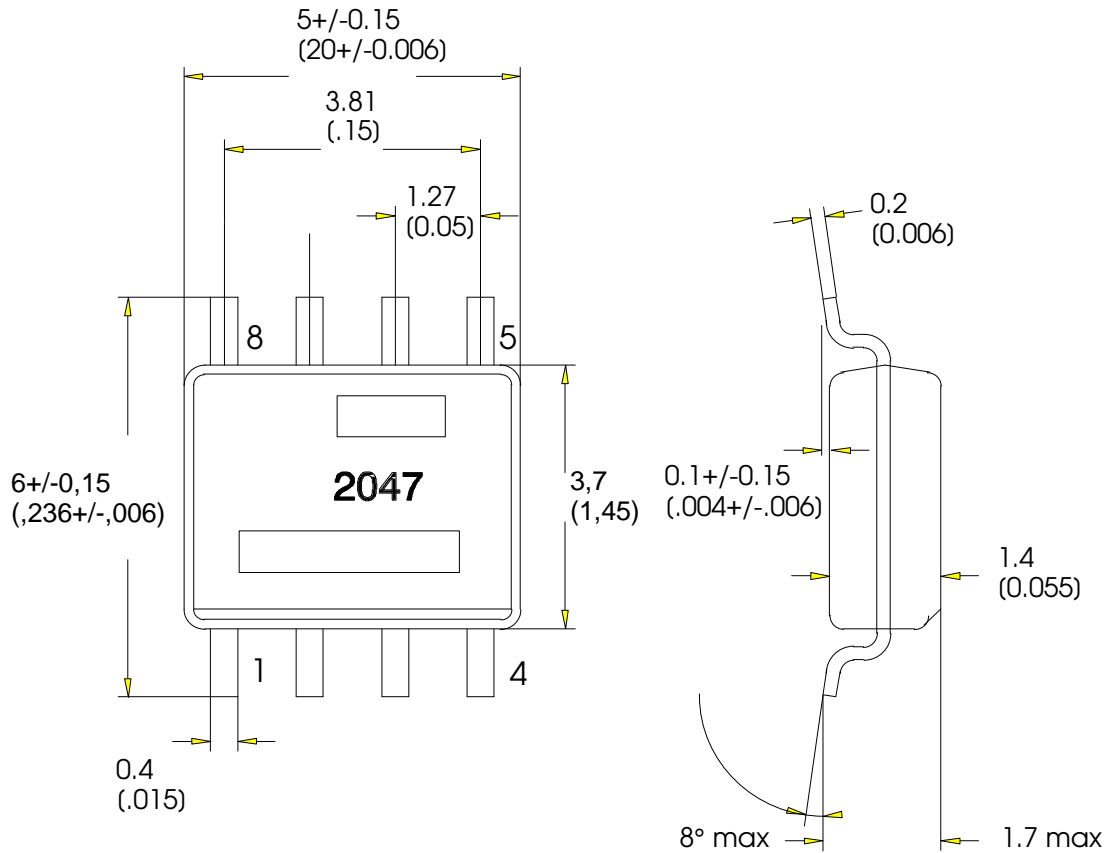

Fig.3: Chip block diagram

**SOIC8 Mechanical Data**



unité: mm

Unit: (In)

Tolérance générale: +/-0.05

(general tolerance: +/-0.002)

Pin out	Signal
1	Vdd
2	CK
3	CKB
4	Ground
5	Ground
6	QB
7	Q
8	Vdd

## Ordering Information

SOIC8 RoHS compliant package: CND2047-DAG/XY  
Stick: XY = 20 Tape& reel: XY = 21

Information furnished is believed to be accurate and reliable. However **United Monolithic Semiconductors S.A.S.** assumes no responsibility for the consequences of use of such information nor for any infringement of patents or other rights of third parties which may result from its use. No license is granted by implication or otherwise under any patent or patent rights of **United Monolithic Semiconductors S.A.S.**. Specifications mentioned in this publication are subject to change without notice. This publication supersedes and replaces all information previously supplied. **United Monolithic Semiconductors S.A.S.** products are not authorised for use as critical components in life support devices or systems without express written approval from **United Monolithic Semiconductors S.A.S.**