

The documentation and process conversion measures necessary to comply with this revision shall be completed by 19 July 2004.

INCH-POUND

MIL-PRF-19500/420H  
 19 April 2004  
 SUPERSEDING  
 MIL-PRF-19500/420G  
 30 December 2002

PERFORMANCE SPECIFICATION SHEET

\* SEMICONDUCTOR DEVICE, DIODE, SILICON, POWER, RECTIFIER, TYPES 1N5550 THROUGH 1N5554, 1N5550US THROUGH 1N5554US, JAN, JANTX, JANTXV, JANS, JANHCA, JANHCB, JANHCC, JANHCD, JANHCE, JANKCA, JANKCD, AND JANKCE

This specification is approved for use by all Departments and Agencies of the Department of Defense.

\* The requirements for acquiring the product described herein shall consist of this specification sheet and MIL-PRF-19500.

1. SCOPE

\* 1.1 Scope. This specification covers the performance requirements for silicon, general purpose, semiconductor diodes. Four levels of product assurance are provided for each encapsulated device type as specified in MIL-PRF-19500. Two levels of product assurance are provided for each unencapsulated device type.

1.2 Physical dimensions. See figure 1 (similar to DO-41) for 1N5550 through 1N5554, figure 2 for 1N5550US through 1N5554US, and figures 3, 4, 5, 6, and 7 for JANHC and JANKC die.

1.3 Maximum ratings. Unless otherwise specified,  $T_C = +25^\circ\text{C}$  and ratings apply to all case outlines.

Col. 1	Col. 2	Col. 3	Col. 4	Col. 5	Col. 6	Col. 7	Col. 8
Type	$V_{(BR)}$	$V_{RWM}$ and $V_{(BR)min}$	$I_{O1}$ $T_L = +55^\circ\text{C};$ $L = .375$ inch (1) (2) (3)	$I_{FSM}$ $I_O = 2$ A dc $t_p = 1/120$ s $T_A = +55^\circ\text{C}$	$T_J$	$I_{O2}$ $T_A =$ $+55^\circ\text{C}$ (2) (4)	$T_{STG}$
		<u>V dc</u>	<u>A dc</u>	<u>A(pk)</u>	<u>°C</u>	<u>A dc</u>	<u>°C</u>
1N5550, 1N5550US	200	200	5	100	-65 to +200	3	-65 to +175
1N5551, 1N5551US	400	400	5	100	-65 to +200	3	-65 to +175
1N5552, 1N5552US	600	600	5	100	-65 to +200	3	-65 to +175
1N5553, 1N5553US	800	800	5	100	-65 to +200	3	-65 to +175
1N5554, 1N5554US	1,000	1,000	5	100	-65 to +200	3	-65 to +175

- (1) Derate linearly at 41.6 mA/°C above  $T_L = +55^\circ\text{C}$  at  $L = .375$  inch (9.53 mm).
- (2) An  $I_O$  of up to 6 A dc is allowable provided that appropriate heat sinking or forced air cooling maintains the maximum junction temperature at or below  $+200^\circ\text{C}$  as proven by the junction temperature rise test (see 6.5).  
 Barometric pressure reduced:  
 1N5550, 1N5551, 1N5552 - 8 mmHg (100,000 feet).  
 1N5553, 1N5554 - 33 mmHg (70,000 feet).
- (3) Does not apply to surface mount devices.
- (4) Derate linearly at 25 mA/°C above  $T_A = +55^\circ\text{C}$ .

\* Comments, suggestions, or questions on this document should be addressed to Defense Supply Center, Columbus, ATTN: DSCC-VAC, P.O. Box 3990, Columbus, OH 43216-5000, or emailed to [Semiconduction@dsccl.dla.mil](mailto:Semiconduction@dsccl.dla.mil). Since contact information can change, you may want to verify the currency of this address information using the ASSIST Online database at <http://www.dodssp.daps.mil>.

MIL-PRF-19500/420H

1.4 Primary electrical characteristics. Unless otherwise specified,  $T_A = +25^\circ\text{C}$ .

Type	$V_f$ at $I_f = 9.0 \text{ A(pk)}$ 1 percent duty cycle, 8.3 ms max pulse width		$I_{R1}$		$I_{R2}$ at $T_A = +100^\circ\text{C}$		$R_{\theta JL}$ $R_{\theta JEC}$
	Min V(pk)	Max V(pk)	$\mu\text{A dc (max) at } V_R \text{ (V dc)}$		$\mu\text{A dc (max) at } V_R \text{ (V dc)}$		See (1)
1N5550, 1N5550US	0.6	1.2	1.0	200	75	200	
1N5551, 1N5551US	0.6	1.2	1.0	400	75	400	
1N5552, 1N5552US	0.6	1.2	1.0	600	75	600	
1N5553, 1N5553US	0.6	1.3	1.0	800	75	800	
1N5554, 1N5554US	0.6	1.3	1.0	1,000	75	1,000	

(1)  $R_{\theta JL} \leq 22^\circ\text{C/W}$  for  $L = .375 \text{ inch (9.52 mm)}$ .

$R_{\theta JEC} \leq 11^\circ\text{C/W}$  for  $L = 0 \text{ (US version)}$ .

2. APPLICABLE DOCUMENTS

\* 2.1 General. The documents listed in this section are specified in sections 3, 4, or 5 of this specification. This section does not include documents cited in other sections of this specification or recommended for additional information or as examples. While every effort has been made to ensure the completeness of this list, document users are cautioned that they must meet all specified requirements of documents cited in sections 3, 4, or 5 of this specification, whether or not they are listed.

2.2 Government documents.

\* 2.2.1 Specifications, standards, and handbooks. The following specifications, standards, and handbooks form a part of this document to the extent specified herein. Unless otherwise specified, the issues of these documents are those cited in the solicitation or contract.

\* DEPARTMENT OF DEFENSE SPECIFICATIONS

MIL-PRF-19500 - Semiconductor Devices, General Specification for.

\* DEPARTMENT OF DEFENSE STANDARDS

MIL-STD-750 - Test Methods for Semiconductor Devices.

\* (Copies of these documents are available online at <http://assist.daps.dla.mil/quicksearch/> or [www.dodssp.dap.mil](http://www.dodssp.dap.mil) or from the Standardization Document Order Desk, 700 Robbins Avenue, Building 4D, Philadelphia, PA 19111-5094.)

2.3 Order of precedence. In the event of a conflict between the text of this document and the references cited herein, the text of this document takes precedence. Nothing in this document, however, supersedes applicable laws and regulations unless a specific exemption has been obtained.

MIL-PRF-19500/420H

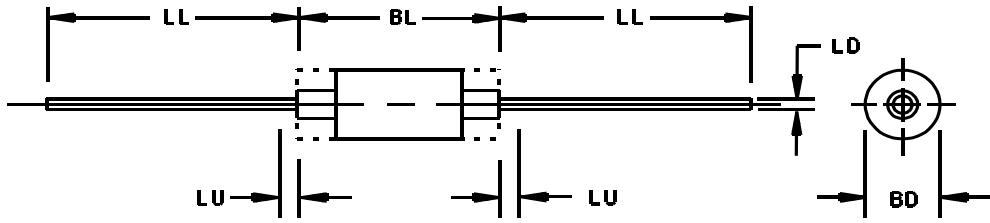

Ltr	Dimensions				Notes
	Inches		Millimeters		
	Min	Max	Min	Max	
BL	.130	.300	3.30	7.62	3
BD	.115	.180	2.92	4.57	3, 4
LD	.037	.042	0.94	1.07	
LL	.900	1.300	22.86	33.02	
LU		.050		1.27	

NOTES:

1. Dimensions are in inches.
2. Millimeters are given for general information only.
3. Dimensions BL and BD include all components of the diode periphery except the sections of leads over which the diameter is controlled.
4. Dimension BD shall be measured at the largest diameter.
5. Dimension LU shall include the sections of the lead over which the diameter is uncontrolled. This uncontrolled area is defined as the zone between the edge of the diode body and extending .050 inch (1.27 mm) onto the leads.
6. In accordance with ASME Y14.5M, diameters are equivalent to  $\phi$ x symbology.

\* FIGURE 1. Physical dimensions of diode 1N5550 through 1N5554, (similar to DO-41).

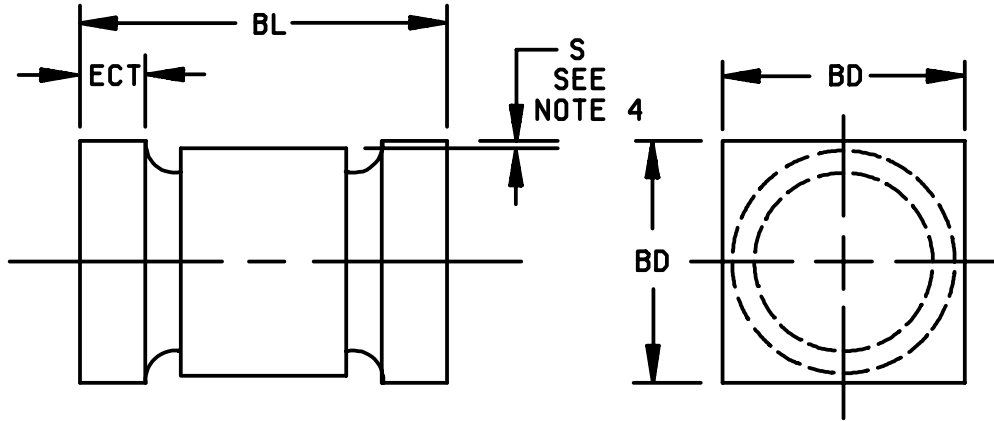

Ltr	Dimensions			
	Inches		Millimeters	
	Min	Max	Min	Max
BL	.200	.275	5.08	6.99
BD	.137	.180	3.48	4.57
ECT	.019	.034	0.48	0.86
S	.003		0.08	

NOTES:

1. Dimensions are in inches.
2. Millimeters are given for general information only.
3. Dimensions are pre-solder dip.
4. Minimum clearance of glass body to mounting surface on all orientations.
5. In accordance with ASME Y14.5M, diameters are equivalent to  $\phi x$  symbology.

\* FIGURE 2. Physical dimensions of 1N5550US through 1N5554US.

MIL-PRF-19500/420H

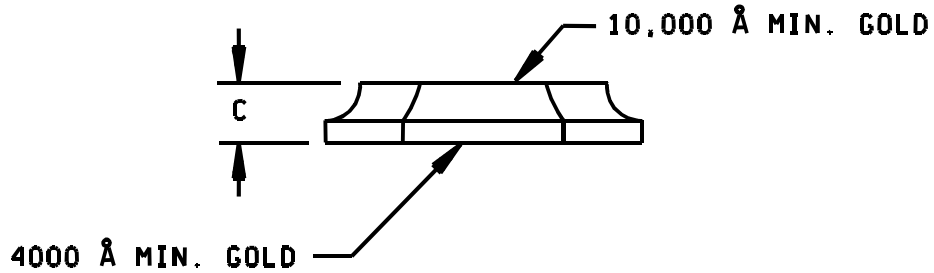
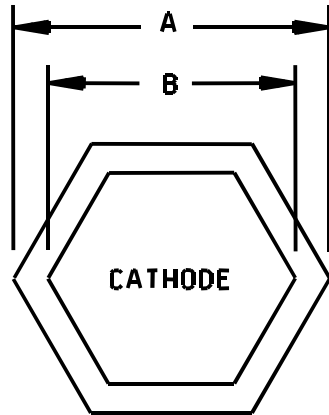

Ltr	Dimensions			
	Inches		Millimeters	
	Min	Max	Min	Max
A	.085	.091	2.16	2.31
B	.072	.078	1.83	1.98
C	.008	.014	0.20	0.36

NOTES:

1. Dimensions are in inches.
2. Millimeters are given for general information only.
3. The physical characteristics are:  
 Top (cathode) Au Thickness = 10,000Å minimum,  
 Back (anode) Au Thickness = 4,000Å minimum.
4. In accordance with ASME Y14.5M, diameters are equivalent to  $\phi x$  symbology.

\* FIGURE 3. JANHCA and JANKCA (A-version) die dimensions.

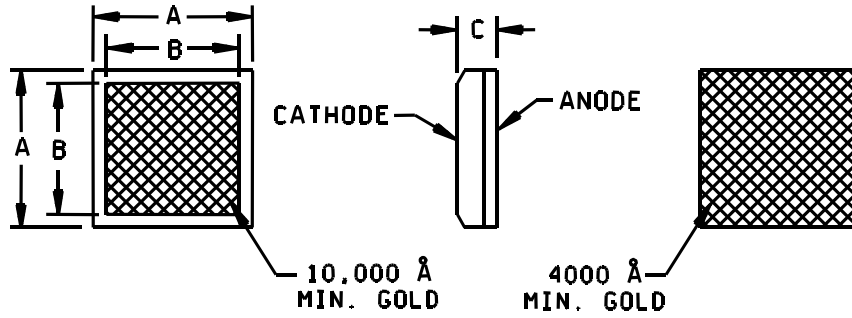

Ltr	Dimensions			
	Inches		Millimeters	
	Min	Max	Min	Max
A	.088	.092	2.24	2.34
B	.070	.077	1.78	1.96
C	.007	.035	0.18	0.89

NOTES:

1. Dimensions are in inches.
2. Millimeters are given for general information only.
3. The physical characteristics are  
 Top (cathode) Au Thickness = 10,000Å minimum,  
 Back (anode) Au Thickness = 4,000Å minimum.
4. In accordance with ASME Y14.5M, diameters are equivalent to  $\phi$ x symbology.

\* FIGURE 4. JANHCB (B-version) die dimensions.

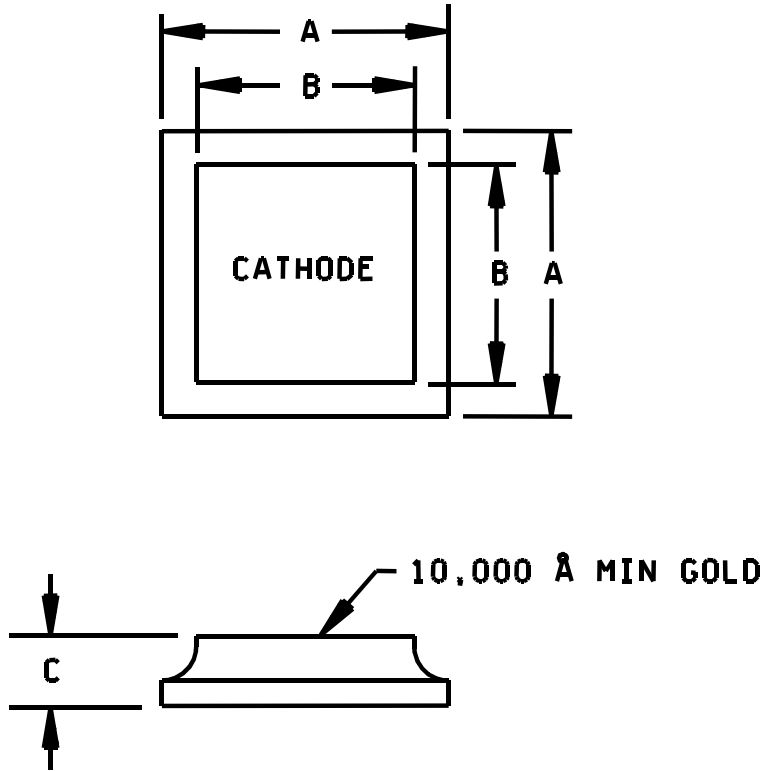

Ltr	Dimensions			
	Inches		Millimeters	
	Min	Max	Min	Max
A	.060	.065	1.52	1.65
B	.052	.058	1.32	1.47
C	.008	.014	0.20	0.36

NOTES:

1. Dimensions are in inches.
2. Millimeters are given for general information only.
3. The physical characteristics are  
 Top (cathode) Au Thickness = 10,000Å minimum,  
 Back (anode) Au Thickness = 4,000Å minimum.
4. In accordance with ASME Y14.5M, diameters are equivalent to  $\phi x$  symbology.

\* FIGURE 5. JANHCC (C-version) die dimensions.

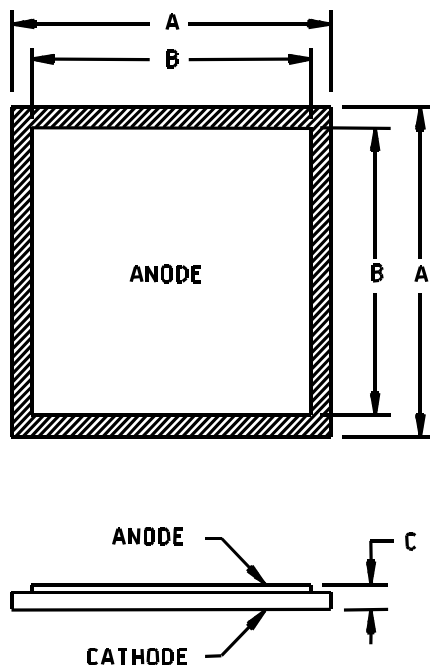

Ltr	Inches		Millimeters	
	Min	Max	Min	Max
A	.081	.087	2.05	2.20
B	.055	.061	1.40	1.55
C	.007	.012	0.18	0.30

NOTES:

1. Dimensions are in inches.
2. Millimeters are given for general information only.
3. The physical characteristics are
  - Top (anode) Al Thickness = 60,000Å minimum.
  - Back (cathode) Au Thickness = 2,500Å minimum,
4. In accordance with ASME Y14.5M, diameters are equivalent to  $\phi$ x symbology.

\* FIGURE 6. JANHCD and JANKCD (D-version) die dimensions.



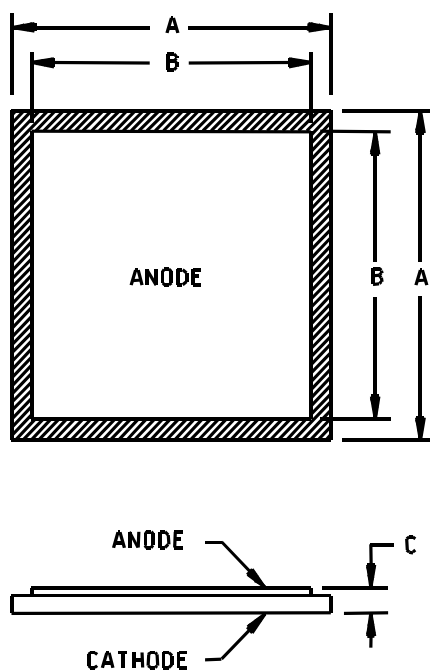

Ltr	Inches		Millimeters	
	Min	Max	Min	Max
A	.081	.087	2.05	2.20
B	.055	.061	1.40	1.55
C	.007	.012	0.18	0.30

NOTES:

1. Dimensions are in inches.
2. Millimeters are given for general information only.
3. The physical characteristics are
  - Top (anode) Al Thickness = 60,000Å minimum.
  - Back (cathode) Al/Ti/Ni/Ag Thickness = 2,500Å minimum,
4. In accordance with ASME Y14.5M, diameters are equivalent to  $\phi$ x symbology.

\* FIGURE 7. JANHCE and JANKCE (E-version) die dimensions.

### 3. REQUIREMENTS

3.1 General. The individual item requirements shall be as specified in MIL-PRF-19500 and as modified herein.

3.2 Qualification. Devices furnished under this specification shall be products that are manufactured by a manufacturer authorized by the qualifying activity for listing on the applicable qualified manufacturer's list (QML) before contract award (see 4.2 and 6.3).

3.3 Abbreviations, symbols, and definitions. Abbreviations, symbols, and definitions used herein shall be as specified in MIL-PRF-19500 and as follows:

\* EC .....End cap.

3.4 Interface and physical dimensions. The interface and physical dimensions shall be as specified in MIL-PRF-19500 and on figure 1 (similar to DO-41) for 1N5550 through 1N5554, figure 2 for 1N5550US through 1N5554US, and figures 3, 4, 5, 6, and 7 (JANHC and JANKC).

3.4.1 Lead finish. Unless otherwise specified, lead or end cap finish shall be solderable in accordance with MIL-PRF-19500, MIL-STD-750, and herein. When solder alloy is used for finish the maximum lead temperature is limited to 175°C maximum. Where a choice of finish is desired, it shall be specified in the acquisition document (see 6.2).

3.4.2 Diode construction. These devices shall be constructed utilizing non-cavity double plug construction with high temperature metallurgical bonding between both sides of the silicon die and terminal pins. Metallurgical bond shall be in accordance with the requirements of category I in MIL-PRF-19500. US version devices shall be structurally identical to the non-surface mount devices except for lead terminations.

3.5 Marking. Marking shall be in accordance with MIL-PRF-19500.

3.5.1 Marking of US version. For US version only, all marking may be omitted from the device except for the cathode marking. All marking which is omitted from the body of the device shall appear on the label of the initial container.

3.5.2 Polarity. The polarity shall be indicated with a contrasting color band to denote the cathode end. Alternately for surface mount (US) devices, a minimum of three evenly spaced contrasting color dots around the periphery of the cathode end may be used. No color coding will be permitted.

3.6 Electrical performance characteristics. Unless otherwise specified herein, the electrical performance characteristics are as specified in 1.3, 1.4, and table I herein.

3.7 Electrical test requirements. The electrical test requirements shall be the subgroups specified in table I herein.

3.8 Workmanship. Semiconductor devices shall be processed in such a manner as to be uniform in quality and shall be free from other defects that will affect life, serviceability, or appearance.

### 4. VERIFICATION

4.1 Classification of inspections. The inspection requirements specified herein are classified as follows:

- a. Qualification inspection (see 4.2).
- b. Screening (see 4.3).
- c. Conformance inspection (see 4.4).

MIL-PRF-19500/420H

4.2 Qualification inspection. Qualification inspection shall be in accordance with MIL-PRF-19500 and as specified herein.

4.2.1 Group E qualification. Group E qualification shall be performed herein for qualification or requalification only. In case qualification was awarded to a prior revision of the specification sheet that did not request the performance of table II tests, the tests specified in table II herein shall be performed on the first inspection lot to this revision to maintain qualification.

4.2.2 JANHC and JANKC die. Qualification shall be in accordance with appendix G of MIL-PRF-19500 and as specified herein.

\* 4.3 Screening (JANS, JANTXV and JANTX levels only). Screening shall be in accordance with table IV of MIL-PRF-19500 (appendix E), and as specified herein. Specified electrical measurements shall be made in accordance with table I herein. Devices that exceed the limits of table I herein shall not be acceptable.

Screen (see table IV of MIL-PRF-19500)	JANS level	JANTXV and JANTX level
1a	Required	Not required
1b	Required	Required (JANTXV only)
2	Optional	Not required
3a	Required	Required
3b	Not applicable	Not applicable
(1) 3c	Thermal impedance (see 4.3.1 and 4.4.1)	Thermal impedance (see 4.3.1 and 4.4.1)
4	Not applicable	Not applicable
5	Not applicable	Not applicable
6	Not applicable	Not applicable
7a	Not applicable	Not applicable
7b	Optional	Optional
8	Required	Not required
9	$V_{F1}$ and $I_{R1}$	Not applicable
10	Method 1038 of MIL-STD-750, condition A	Method 1038 of MIL-STD-750, condition A
11	$V_{F1}$ and $I_{R1}$ ; $\Delta V_{F1} \leq \pm 0.1$ V dc $\Delta I_{R1} \leq 250$ nA dc or 100 percent of initial value whichever is greater.	$V_{F1}$ and $I_{R1}$
12	Required, see 4.3.2	Required, see 4.3.2
(2) 13	Subgroups 2 and 3 of table I herein; $\Delta I_{R1} \leq 100$ percent of initial reading or 250 nA dc, whichever is greater. $\Delta V_{F1} \leq \pm 1$ V dc change from initial value. Scope display evaluation (see 4.5.3)	Subgroup 2 of table I herein; $\Delta I_{R1} \leq 100$ percent of initial reading or 250 nA dc, whichever is greater. $\Delta V_{F1} \leq \pm 1$ V dc change from initial value. Scope display evaluation (see 4.5.3)
14a	Not applicable	Not applicable
(3) 14b	Required	Required
15	Required	Not required
16	Required	Not required

- (1) Thermal impedance shall be performed any time after sealing provided temperature cycling is performed in accordance with MIL-PRF-19500, screen 3 prior to this thermal test.
- (2)  $Z_{\theta JX}$  is not required in screen 13, if already previously performed.
- (3) For clear glass diodes, the hermetic seal (gross leak) may be performed at any time after temperature cycling.

\* 4.3.1 Thermal impedance  $Z_{\theta JX}$  measurements for screening. The  $Z_{\theta JX}$  measurements shall be performed in accordance with method 3101 of MIL-STD-750. The maximum screen limit shall be developed by the supplier using statistical methods and it shall not exceed the table I, subgroup 2 herein. See 4.4.1 for test conditions.

4.3.1.1 Thermal impedance ( $Z_{\theta JX}$  measurements) for initial qualification or requalification. The  $Z_{\theta JX}$  measurements shall be performed in accordance with method 3101 of MIL-STD-750 (read and record date  $Z_{\theta JX}$ ).  $Z_{\theta JX}$  shall be supplied on one lot (500 pieces minimum and a thermal response curve shall be submitted.) Twenty-two of these samples shall be serialized and provided to the qualifying activity for correlation prior to shipment of parts. Measurements conditions shall be in accordance with 4.4.1.

\* 4.3.2 Power burn-in conditions. Power burn-in conditions are as follows (see 4.5.2, 4.5.2.1) adjust  $I_O$  to achieve the required  $T_J$ .

4.3.3 Screening (JANHC and JANKC). Screening of die shall be in accordance with appendix G of MIL-PRF-19500. As a minimum, die shall be 100-percent probed to ensure compliance with table I, subgroup 2. Burn-in duration for the JANKC level follows JANS requirements; the JANHC follows JANTX requirements.

\* 4.4 Conformance inspection. Conformance inspection shall be in accordance with MIL-PRF-19500 and as specified herein.

4.4.1 Group A inspection. Group A inspection shall be conducted in accordance with MIL-PRF-19500 and table I herein. The following test conditions shall be used for  $Z_{\theta JX}$ , table I:  $Z_{\theta JX} \leq 1.5^\circ\text{C/W}$ .

- a.  $I_M$  ..... 1 mA to 10 mA.
- b.  $I_H$  ..... 5 A minimum.
- c.  $t_H$  ..... 10 ms.
- d.  $t_{MD}$  ..... 100  $\mu\text{s}$  maximum.
- e.  $t_{SW}$  ..... 5  $\mu\text{s}$  maximum.

MIL-PRF-19500/420H

\* 4.4.2 Group B inspection. Group B inspection shall be conducted in accordance with the tests and conditions specified for subgroup testing in table VIa (JANS) and table VIb (JAN, JANTX and JANTXV) of MIL-PRF-19500. Electrical measurements (end-points) requirements shall be in accordance with the applicable inspections of table I, subgroup 2 herein. For delta requirements see table III herein.

\* 4.4.2.1 Group B inspection, table VIa (JANS) of MIL-PRF-19500. For B5, if a failure occurs, resubmission shall be at the test conditions of the original sample.

<u>Subgroup</u>	<u>Method</u>	<u>Condition</u>
B3	1056	0°C to +100°C, 25 cycles.
B3	1051	-55°C to +175°C, 100 cycles.
B3	4066	I <sub>FSM</sub> = rated I <sub>FSM</sub> (see col. 5 of 1.3); 10 surges of 8.3 ms each at 1 minute intervals, superimposed on I <sub>O</sub> = 0, V <sub>RWM</sub> = 0.
B4	1037	I <sub>O</sub> = I <sub>O2</sub> rated minimum (see col. 4 of 1.3) V <sub>R</sub> = rated V <sub>RWM</sub> (see col. 3 of 1.3 and 4.5.5); 2,000 cycles.
B5	1027	I <sub>O</sub> = I <sub>O2</sub> rated minimum (see col. 4 of 1.3); apply V <sub>R</sub> = rated V <sub>RWM</sub> (see col. 3 of 1.3 and 4.5.2) adjust I <sub>O</sub> to achieve T <sub>J</sub> minimum; f = 50-60 Hz.  Option 1: T <sub>A</sub> = + 30°C max. ; T <sub>J</sub> = 225°C minimum; t = 216 hours; n = 45 c = 0.  or Option 2: T <sub>A</sub> = + 100°C max. ; T <sub>J</sub> = 275°C minimum; t = 96 hours, n = 22, c = 0.
* B6	3101 or 4081	R <sub>θJL</sub> (maximum) ≤ 22°C/W; L = .375 inch (9.53 mm). For surface mount devices (US version), R <sub>θJEC</sub> ≤ 11°C/W.
B7		Peak reverse power, see 4.5.5. P <sub>RM</sub> ≥ 1,000 W. Test shall be performed on each subplot; sampling plan n = 10, c = 0, electrical end-points, see table I, subgroup 2 herein.

\* 4.4.2.2 Group B inspection, table VIb (JAN, JANTX and JANTXV of MIL-PRF-19500).

<u>Subgroup</u>	<u>Method</u>	<u>Condition</u>
B2	1056	0°C to +100°C, 10 cycles.
* B2	1051	-55°C to +175°C, 25 cycles.
B3	1027	T <sub>J</sub> = 150°C minimum (see 4.5.2.1). Adjust I <sub>O</sub> to achieve the required T <sub>J</sub> ; apply V <sub>R</sub> = rated V <sub>RWM</sub> (see col. 3 of 1.3), f = 50-60 Hz (see 4.5.2).
B5		Not applicable .

4.4.3 Group C inspection. Group C inspection shall be conducted in accordance with the tests and conditions specified for subgroup testing in table VII of MIL-PRF-19500. Electrical measurements (end-points) shall be in accordance with table I, subgroup 2 herein. See table III herein for delta limits when applicable.

\* 4.4.3.1 Group C inspection, table VII of MIL-PRF-19500.

<u>Subgroup</u>	<u>Method</u>	<u>Condition</u>
C2	1056	0°C to +100°C, 10 cycles.
C2	1051	-55°C to +175°C, 25 cycles.
C2	2036	Tension: Test condition A; weight = 5 pounds; t = 30 seconds. Lead fatigue: Test condition E; weight 2 pounds.
NOTE: Both tension and lead fatigue are not applicable for US devices.		

\* C5            3101        See 4.5.5.  
                  or  
                  4081

C6            1027         $T_J = 150^\circ\text{C}$  minimum (see 4.5.2.1).  $I_O = I_{O2} = 3$  A dc minimum; adjust  $I_O$  to achieve the required  $T_J$ ; apply  $V_R = \text{rated } V_{RWM}$  (see col. 3 of 1.3),  $f = 50\text{-}60$  Hz (see 4.5.2.1).

\* 4.4.4 Group E inspection. Group E inspection shall be conducted in accordance with the conditions specified for subgroup testing in appendix E, table IX of MIL-PRF-19500 and as specified herein. Electrical measurements (end-points) shall be in accordance with table I, subgroup 2 herein. See table III for delta limits when applicable.

4.5 Methods of inspection. Methods of inspection shall be as specified in appropriate tables and as follows.

4.5.1 Pulse measurements. Conditions for pulse measurement shall be as specified in section 4 of MIL-STD-750.

4.5.2 Burn-in and life tests. These tests shall be conducted with a half-sine waveform of the specified peak voltage impressed across the diode in the reverse direction followed by a half-sine waveform of the specified average rectified current. The forward conduction angle of the rectified current shall be neither greater than 180 degrees, nor less than 150 degrees.

\* 4.5.2.1 Free air burn-in. Deliberate heat sinking, baffles to create an oven, forced air-cooling or heating is prohibited unless otherwise approved by the qualifying activity. The use of a current limiting or ballast resistor is permitted provided that each DUT still sees the full  $P_t$  (minimum) and that the minimum applied voltage, where applicable, is maintained through out the burn-in period.  $T_J = 135^\circ\text{C}$  minimum for screening and  $T_J = 150^\circ\text{C}$  for 4.4.2 and 4.4.3 life tests. Use method 3100 of MIL-STD-750 to measure  $T_J$ .

4.5.3 Scope display evaluation. Scope display evaluation shall be sharp and stable in accordance with method 4023 of MIL-STD-750. Scope display may be performed on ATE (automatic test equipment) for screening only, with the approval of the qualifying activity. Scope display in table I, subgroup 4 shall be performed on a scope. The reverse current ( $I_{BR}$ ) over the knee shall be 500  $\mu\text{A}$  peak.

4.5.4 Thermal resistance. Thermal resistance measurements shall be conducted in accordance with test method 3101 or 4081 of MIL-STD-750. Read and record data in accordance with group E herein and shall be included in the qualification report. Forced moving air or draft shall not be permitted across the devices during test. The maximum limit under these test condition shall be  $R_{\theta JL} \leq 22^{\circ}\text{C/W}$  for  $L = .375$  (9.53 mm);  $R_{\theta JEC} \leq 11^{\circ}\text{C/W}$  for  $L = 0$  (US version). The following conditions shall apply:

- a.  $I_H$  ..... 2 A minimum.
- b.  $t_H$  ..... Thermal equilibrium.
- c.  $I_M$  ..... 1.0 mA to 10 mA.
- d.  $t_{MD}$  ..... 100  $\mu\text{s}$  maximum.

The device shall be allowed to reach equilibrium at current  $I_H$  before the measurement shall be made ( $t_H \geq 25$  sec).

LS = Lead spacing = .375 inch (9.53 mm) minimum for leaded devices and LS = 0 minimum for unleaded devices as defined (see figure 8):

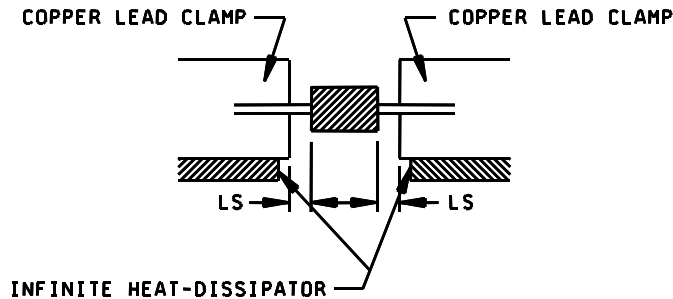

FIGURE 8. Mounting arrangement.

4.5.5 Peak reverse power test. A 20 microsecond half-sine waveform of current shall be used and peak reverse power shall be determined by the product of peak reverse voltage and peak reverse current. A 20 microsecond square waveform may also be used with the approval of the qualifying activity (see figure 9).

MIL-PRF-19500/420H

\* TABLE I. Group A inspection.

Inspection <u>1/</u>	MIL-STD-750		Symbol	Limits		Unit
	Method	Conditions		Min	Max	
<u>Subgroup 1</u>						
Visual and mechanical inspection	2071					
<u>Subgroup 2</u>						
Thermal impedance	3101	See 4.3.1 and 4.4.1.	$Z_{\theta JX}$		1.5	°C/W
Forward voltage	4011	$I_F = 9.0$ A(pk); duty cycle $\leq 2$ percent (pulsed see 4.5.1); $t_p \leq 8.3$ ms	$V_{F1}$			
1N5550, 1N5550US				0.6	1.2	V(pk)
1N5551, 1N5551US				0.6	1.2	V(pk)
1N5552, 1N5552US				0.6	1.2	V(pk)
1N5553, 1N5553US				0.6	1.3	V(pk)
1N5554, 1N5554US				0.6	1.3	V(pk)
Forward voltage	4011	$I_F = 1.5$ A dc	$V_{F1}$	0.5	1.0	V dc
Reverse current leakage	4016	DC method	$I_{R1}$			
1N5550, 1N5550US		$V_R = 200$ V dc			1.0	$\mu$ A dc
1N5551, 1N5551US		$V_R = 400$ V dc			1.0	$\mu$ A dc
1N5552, 1N5552US		$V_R = 600$ V dc			1.0	$\mu$ A dc
1N5553, 1N5553US		$V_R = 800$ V dc			1.0	$\mu$ A dc
1N5554, 1N5554US		$V_R = 1,000$ V dc			1.0	$\mu$ A dc
Breakdown voltage (diodes)	4021		$V_{BR1}$			
1N5550, 1N5550US		$I_R = 50$ $\mu$ A dc		200		V dc
1N5551, 1N5551US		$I_R = 50$ $\mu$ A dc		400		V dc
1N5552, 1N5552US		$I_R = 50$ $\mu$ A dc		600		V dc
1N5553, 1N5553US		$I_R = 50$ $\mu$ A dc		800		V dc
1N5554, 1N5554US		$I_R = 50$ $\mu$ A dc		1,000		V dc

See footnote at end of table.



TABLE I. Group A inspection - Continued.

Inspection <u>1</u> /	MIL-STD-750		Symbol	Limits		Unit
	Method	Conditions		Min	Max	
<u>Subgroup 3</u>						
High temperature operation:		$T_A = +100^\circ\text{C}$				
Reverse current leakage		DC method	$I_{R2}$			
Reverse current leakage	4016	DC method				
1N5550, 1N5550US		$V_R = 200\text{ V dc}$			75	$\mu\text{A dc}$
1N5551, 1N5551US		$V_R = 400\text{ V dc}$			75	$\mu\text{A dc}$
1N5552, 1N5552US		$V_R = 600\text{ V dc}$			75	$\mu\text{A dc}$
1N5553, 1N5553US		$V_R = 800\text{ V dc}$			75	$\mu\text{A dc}$
1N5554, 1N5554US		$V_R = 1,000\text{ V dc}$			75	$\mu\text{A dc}$
Forward voltage	4011	$I_F = 9.0\text{ A(pk)}$ ; duty cycle $\leq 2$ percent (pulsed see 4.5.1); $t_p \leq 8.3\text{ ms}$	$V_{F2}$			
1N5550, 1N5550US					1.2	V(pk)
1N5551, 1N5551US					1.2	V(pk)
1N5552, 1N5552US					1.2	V(pk)
1N5553, 1N5553US					1.3	V(pk)
1N5554, 1N5554US					1.3	V(pk)
Low temperature operation:		$T_A = -55^\circ\text{C}$				
Forward voltage	4011	$I_F = 9.0\text{ A(pk)}$ ; duty cycle $\leq 2$ percent (pulsed); $t_p \leq 8.3\text{ ms}$	$V_{F3}$		1.5	V(pk)
Forward voltage	4011	$I_F = 1.5\text{ A dc}$	$V_{F4}$	0.5	1.2	V dc
Breakdown voltage (diodes)	4021		$V_{BR2}$			
1N5550, 1N5550US		$I_R = 50\ \mu\text{A dc}$		200		V dc
1N5551, 1N5551US		$I_R = 50\ \mu\text{A dc}$		400		V dc
1N5552, 1N5552US		$I_R = 50\ \mu\text{A dc}$		600		V dc
1N5553, 1N5553US		$I_R = 50\ \mu\text{A dc}$		800		V dc
1N5554, 1N5554US		$I_R = 50\ \mu\text{A dc}$		1,000		V dc
<u>Subgroup 4</u>						
Reverse recovery time	4031	Condition B1	$t_{rr}$		2.0	$\mu\text{s}$
Scope display evaluation	4023	See 4.5.3, $n = 116$ , $c = 0$				

See footnote at end of table.

TABLE I. Group A inspection - Continued.

Inspection <u>1/</u>	MIL-STD-750		Symbol	Limits		Unit
	Method	Conditions		Min	Max	
<u>Subgroups 5</u> Not applicable						
<u>Subgroup 6</u> Forward surge	4066	I <sub>FSM</sub> = rated (see col. 6 of 1.3); 10 surges of 8.3 ms each at 1 minute intervals, superimposed on I <sub>O</sub> = 0, V <sub>RSM</sub> = 0				
Electrical measurement <u>Subgroup 7</u> Not applicable		See table I, subgroup 2.				

1/ For sampling plan, see MIL-PRF-19500.

MIL-PRF-19500/420H

\* TABLE II. Group E inspection (all quality levels) for qualification and requalification only.

Inspection	MIL-STD-750		Sampling plan
	Method	Conditions	
<u>Subgroup 1</u>			45 devices c = 0
Thermal shock	1056	20 cycles, condition D except low temperature shall be achieved using liquid nitrogen (-195°C). Perform a visual for cracked glass.	
Temperature cycling	1051	500 cycles, condition C, -65°C to +175°C.	
Electrical measurements		See table I, subgroup 2 herein.	
<u>Subgroup 2</u>			22 devices c = 0
Steady state dc blocking life	1048	1,000 hours, condition A; $V_R = V_{RWM}$	
Electrical measurements		See table I, subgroup 2 and table III herein.	
* <u>Subgroup 3</u>			3 devices c = 0
DPA (Decap analysis)	2101	Cross section and scribe and break. Separate samples shall be used for each test.	
* <u>Subgroup 4</u>			
Thermal impedance curves		Each supplier shall submit their (typical) maximum design thermal impedance curves. In addition, optional test conditions and $Z_{\theta JX}$ limit shall be provided to the qualifying activity in the qualification report.	
Junction temperature rise (see 4.5.2.1)		See figures 10, 11, and 12; $\Delta T_J \leq 120^\circ\text{C}$ ; $L = .375$ inch; $T_L = 55^\circ\text{C}$ ; $I_O = 5$ A dc.	
<u>Subgroup 5</u>			22 devices c = 0
Barometric pressure, reduced (altitude operation)	1001	Pressure (see 1.3); $t = 1$ min. DC method; $V_R = V_{RWM}$ (see 1.3); $I_{R1} = 1.0$ $\mu\text{A}$ dc maximum	
Electrical measurement		See table I, subgroup 2 and table III herein.	
* <u>Subgroup 6</u>			n = 3, c = 0
ESD	1020		

See footnotes at end of table.

MIL-PRF-19500/420H

\* TABLE II. Group E inspection (all quality levels) for qualification and requalification only - Continued.

Inspection	MIL-STD-750		Sampling plan
	Method	Conditions	
* <u>Subgroup 8</u> Peak reverse power  Electrical measurement		See 4.5.5 herein. Peak reverse power ( $P_{RM}$ )= shall be characterized by the supplier and this data shall be available to the Government. Test shall be performed on each subplot.  During the $P_{RM}$ test, the voltage ( $V_{BR}$ ) shall be monitored to verify it has not collapsed. Any collapse in $V_{BR}$ during or after the $P_{RM}$ test or rise in leakage current ( $I_R$ ) after the test that exceeds $I_{R1}$ in table I shall be considered a failure to that level of applied $P_{RM}$ . Progressively higher levels of $P_{RM}$ shall be applied until failure occurs on all devices within the chosen sample size to characterize each subplot.	n = 45
<u>Subgroup 9</u> <sup>1/</sup> Resistance to glass cracking	1057	Step stress to destruction by increasing cycles or up to a maximum of 25 cycles.	
* <u>Subgroup 10</u> Forward surge  Electrical measurement	4066	$I_{FSM} = 80$ A(pk); 10 surges of 8.3 ms each at 1 minute intervals, superimposed on $I_O = 2$ A dc; $V_{RWM} =$ rated $V_{RWM}$ (see col. 3 of 1.3). $T_A = +100^\circ\text{C}$ .  See table I, subgroup 2 and table III herein.	22 devices c = 0

<sup>1/</sup> The sample size for this step stress requirement shall be determined by the supplier. A statistically significant sample size is required.

\* TABLE III. Delta requirements. 1/ 2/ 3/ 4/ 5/

Step	Inspection	MIL-STD-750		Symbol	Limits		Unit
		Method	Conditions		Min	Max	
1.	Reverse current leaking change	4016	DC method	$\Delta I_{R1}$ 4/		$\pm 100$ percent of initial value or $\pm 250$ nA dc, whichever is greater.	
2.	Forward voltage change	4011	$I_F = 1.5$ A dc; pulsed (see 4.5.1)	$\Delta V_{F1}$ 4/		$\pm 50$ mV dc maximum change from previous measured value.	

1/ The electrical measurements for table VIa (JANS) of MIL-PRF-19500 are as follows:

- a. Subgroup 3, see table III herein, step 2.
- b. Subgroup 4, see table III herein, step 2.
- c. Subgroup 5, see table III herein, steps 1 and 2.

2/ The electrical measurements for table VIb (JAN, , JANTX and JANTXV) of MIL-PRF-19500 are as follows:

- a. Subgroup 3, see table III herein, step 1.
- b. Subgroup 6, see table III herein, step 1.

3/ The electrical measurements for table VII of MIL-PRF-19500 are as follows:

- a. Subgroup 2, see table III herein, step 1 (JANS).
- b. Subgroup 6, see table III herein, step 1 and 2 (JANS), step 1 (JAN, JANTX, JANTXV and).

4/ Devices which exceed the table I limits for this test shall not be accepted.

5/ The electrical measurements for table IX of MIL-PRF-19500 are as follows:

- a. Subgroup 2 and 10, see table III herein, step 1 and 2.

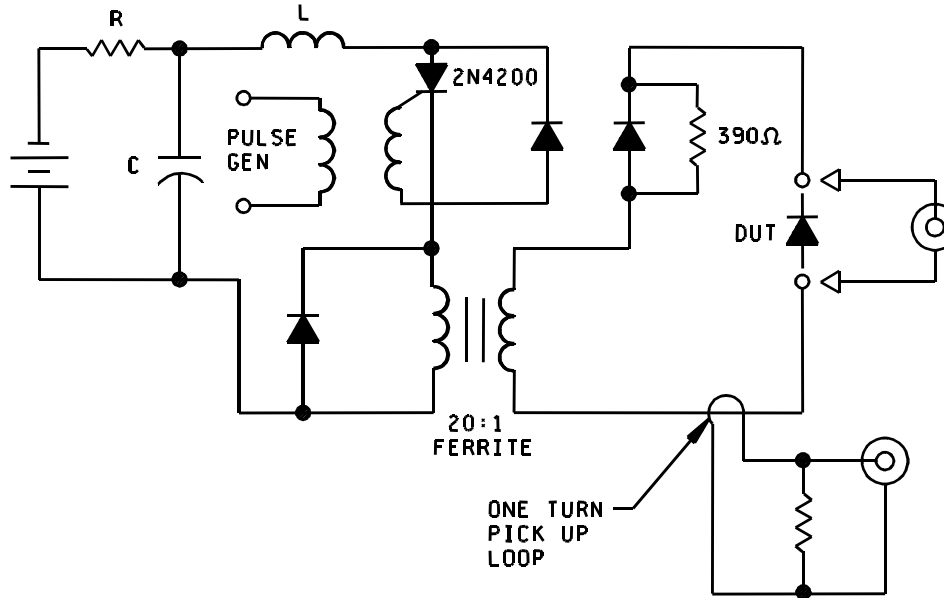

NOTES: \*

- L = 13T H22 on 1 inch (25.4 mm) diameter form (air core).
- C ~ 1 to 10  $\mu$ fd to give 20  $\mu$ s pulse width.
- V - Adjustable to 200 volts for power desired in DUT.
- D1 - 3 kV; 600 Ma (1N3647 or equivalent).
- D2, D3 - 600 V; 3A (1N5552 or equivalent).

\* Values not stated are determined at the time of test.

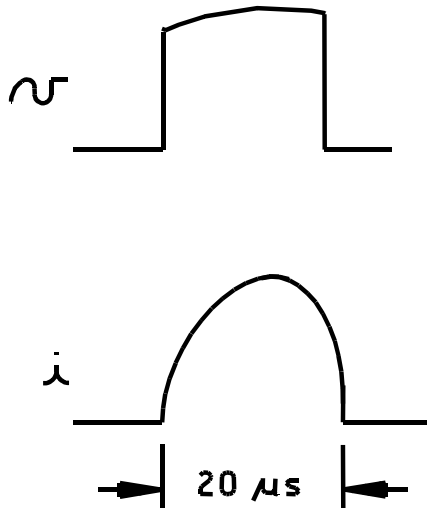

**TYPICAL WAVEFORMS**

FIGURE 9. Typical peak reverse power measurement circuit and waveforms.

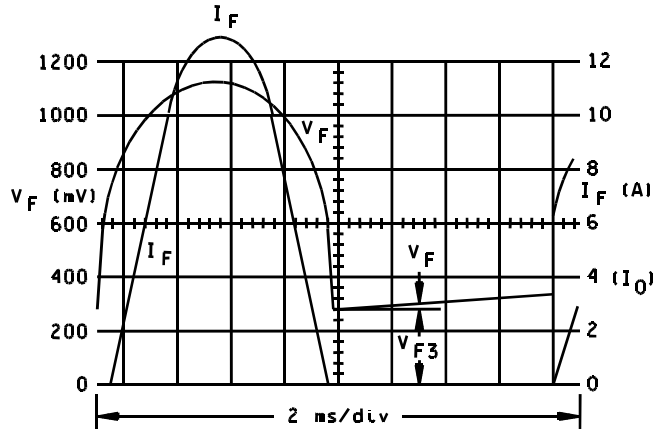

NOTE: Blocking diode shall have a forward current rating  $\geq 6$  A dc.

FIGURE 10. Junction temperature rise test circuit.

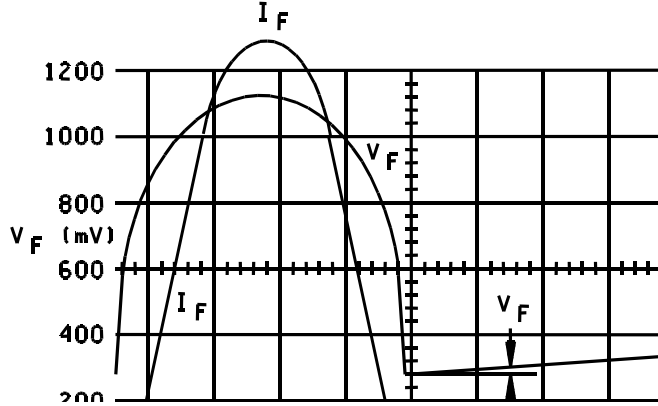

FIGURE 11. Junction temperature test oscillogram (typical).

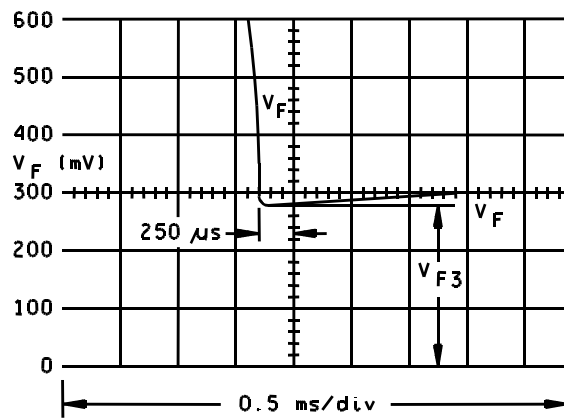

FIGURE 12. Expanded oscillogram of  $V_F$ .



## 5. PACKAGING

\* 5.1 Packaging. For acquisition purposes, the packaging requirements shall be as specified in the contract or order (see 6.2). When actual packaging of materiel is to be performed by DoD or in-house contractor personnel, these personnel need to contact the responsible packaging activity to ascertain packaging requirements. Packaging requirements are maintained by the Inventory Control Point's packaging activities within the Military Service or Defense Agency, or within the Military Service's system commands. Packaging data retrieval is available from the managing Military Department's or Defense Agency's automated packaging files, CD-ROM products, or by contacting the responsible packaging activity.

## 6. NOTES

(This section contains information of a general or explanatory nature that may be helpful, but is not mandatory.)

6.1 Intended use. The notes specified in MIL-PRF-19500 are applicable to this specification.

\* 6.2 Acquisition requirements. Acquisition documents should specify the following:

- a. Title, number, and date of this specification.
- b. Packaging requirements (see 5.1).
- c. Lead finish (see 3.4.1).
- d. Product assurance level and type designator.

6.3 Qualification. With respect to products requiring qualification, awards will be made only for products which are, at the time of award of contract, qualified for inclusion in Qualified Manufacturers List (QML 19500) whether or not such products have actually been so listed by that date. The attention of the contractors is called to these requirements, and manufacturers are urged to arrange to have the products that they propose to offer to the Federal Government tested for qualification in order that they may be eligible to be awarded contracts or orders for the products covered by this specification. Information pertaining to qualification of products may be obtained from Defense Supply Center, Columbus, ATTN: DSCC/VQE, P.O. Box 3990, Columbus, OH 43216-5000 or e-mail vqe.chief@dla.mil.

6.4 Supersession information. Devices covered by this specification supersede the manufacturers' and users' Part or Identifying Number (PIN). This information in no way implies that the manufacturers' PIN's are suitable as a substitute for the military PIN.

6.5 Applications data. See figure 13 for maximum power in watts as a function of lead temperature at a distance "L" from the diode body. Device current capability with lead-dissipators or body forced-air-cooling, may be determined from figure 14, which shows maximum average rectified current versus lead temperature as a function of the distance L from the diode body at which lead temperature is measured.

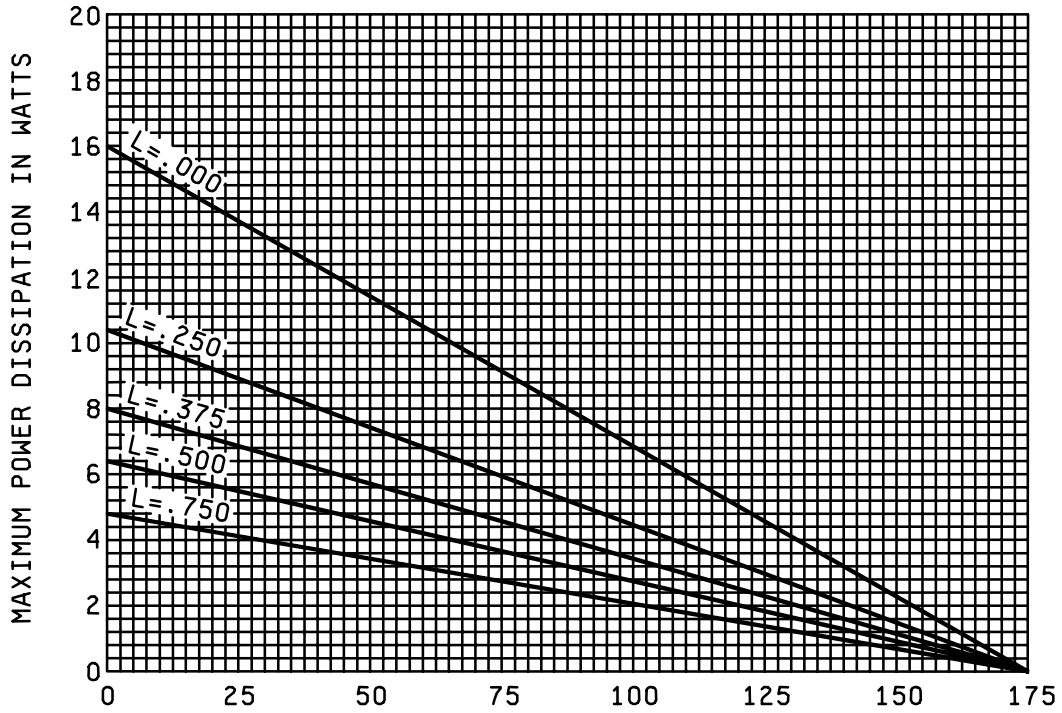

Maximum lead temperature in °C ( $T_L$ ) at point "L" from body (for maximum operating junction temperature of +175°C with equal two-lead conditions).

L		$R_{\theta JL}$
Inches	mm	°C/W
.000	0.00	11
.250	6.35	16.5
.375	9.53	22
.500	12.70	26
.750	19.05	35.5

NOTES:

1. Dimensions are in inches.
2. Millimeters are given for general information only.
3. In accordance with ASME Y14.5M, diameters are equivalent to  $\phi x$  symbology.

\* FIGURE 13. Maximum power in watts versus lead temperature.

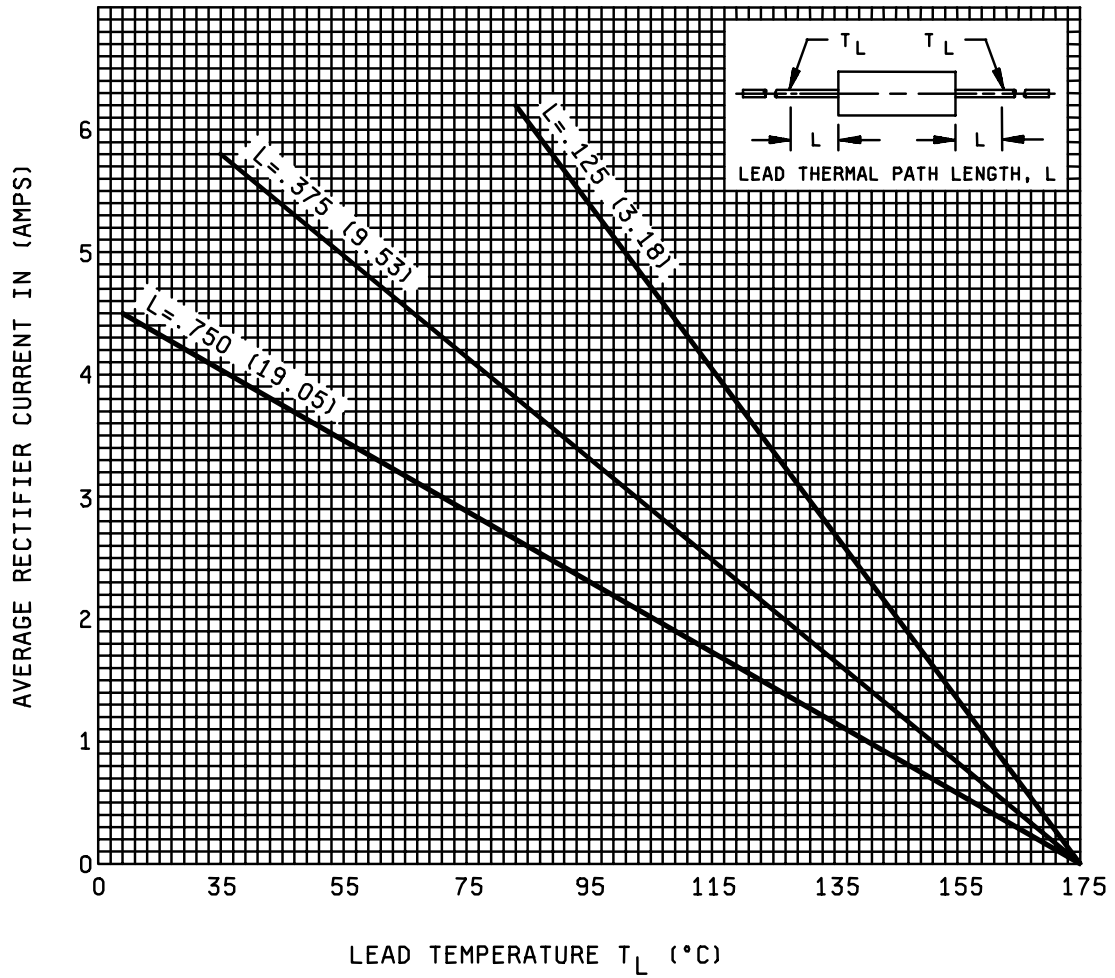

NOTES

1. Dimensions are in inches.
2. Millimeters are given for general information only.

FIGURE 14. Maximum current vs lead temperature.

6.6 Suppliers of die. The qualified die suppliers with the applicable letter version (example JANHCA1N5550) will be identified on the QML.

JANC ordering information					
PIN	Manufacturer				
	14552	60211	13409	33178	33178
1N5550	JANHCA1N5550 JANKCA1N5550	JANHCB1N5550	JANHCC1N5550	JANHCD1N5550	JANHCE1N5550
1N5551	JANHCA1N5551 JANKCA1N5551	JANHCB1N5551	JANHCC1N5551	JANHCD1N5551	JANHCE1N5551
1N5552	JANHCA1N5552 JANKCA1N5552	JANHCB1N5552	JANHCC1N5552	JANHCD1N5552	JANHCE1N5552
1N5553	JANHCA1N5553 JANKCA1N5553	JANHCB1N5553	JANHCC1N5553	JANHCD1N5553	JANHCE1N5553
1N5554	JANHCA1N5554 JANKCA1N5554	JANHCB1N5554	JANHCC1N5554	JANHCD1N5554	JANHCE1N5554

6.7 Changes from previous issue. The margins of this specification are marked with asterisks to indicate where changes from the previous issue were made. This was done as a convenience only and the Government assumes no liability whatsoever for any inaccuracies in these notations. Bidders and contractors are cautioned to evaluate the requirements of this document based on the entire content irrespective of the marginal notations and relationship to the last previous issue.

Custodians:  
 Army - CR  
 Navy - EC  
 Air Force - 11  
 DLA - CC

Preparing activity:  
 DLA - CC

Review activities:  
 Army - AR, MI, SM  
 Navy - AS, MC  
 Air Force - 19, 71, 84, 99

(Project 5961-2760)

\* NOTE: The activities listed above were interested in this document as of the date of this document. Since organizations and responsibilities can change, you should verify the currency of the information above using the ASSIST Online database at <http://www.dodssp.daps.mil>.