

**FEATURES**

- 0.8 INCH (20.32mm) DIGIT HEIGHT.
- CONTINUOUS UNIFORM SEGMENTS.
- CHOICE OF FIVE BRIGHT COLORS-RED/BRIGHT RED/GREEN/YELLOW/ORANGE.
- LOW POWER REQUIREMENT.
- EXCELLENT CHARACTERS APPEARANCE.
- HIGH CONTRAST.
- HIGH BRIGHTNESS.
- WIDE VIEWING ANGLE.
- SOLID STATE RELIABILITY.
- CATEGORIZED FOR LUMINOUS INTENSITY.
- I. C. COMPATIBLE.
- EASY MOUNTING ON P.C. BOARD OR SOCKETS.

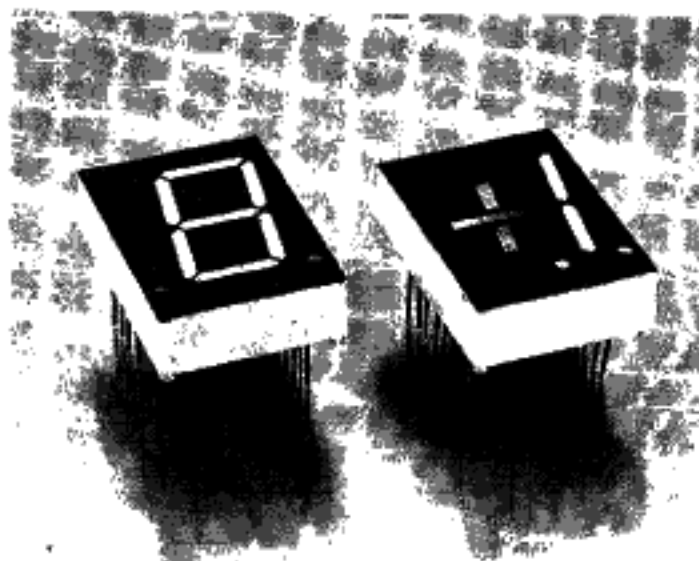

SEVEN SEGMENT LED DISPLAYS  
& ALPHANUMERIC DISPLAYS

**DESCRIPTION**

The LTS-3400L series are 0.8 inch (20.32mm) height single digit displays.

The red series devices utilized LED chips which are made from GaAsP on a GaAs substrate. The bright red and green series devices utilize LED chips which are made from GaP on a transparent GaP substrate. The orange series devices utilize LED chips which are made from GaAsP on a transparent GaP substrate. All devices have gray face and white segment color.

**DEVICES**

PART NO. LTS-					DESCRIPTION	PACKAGE DIMENSION	INTERNAL CIRCUIT DIAGRAM
RED	BRIGHT RED	GREEN	YELLOW	ORANGE			
3401LR	3401LP	3401LG	3401LY	3401LE	Common Anode, Rt. & Lt. Hand Decimal	A	A
3403LR	3403LP	3403LG	3403LY	3403LE	Common Cathode, Rt. & Lt. Hand Decimal	A	B
3406LR	3406LP	3406LG	3406LY	3406LE	Universal, ± 1 Overflow, Rt. Hand Decimal	B	C

# PACKAGE DIMENSIONS

A. LTS-3401L/3403L

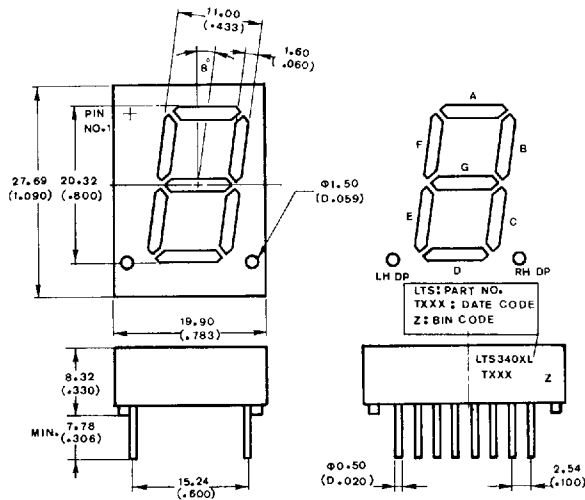

B. LTS-3406L

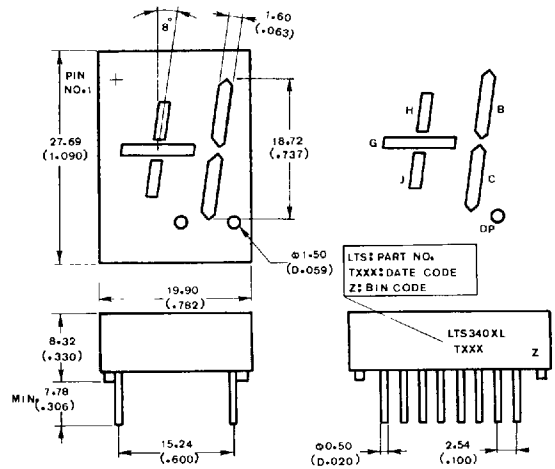

NOTE: All dimensions are in millimeters tolerance are: (inches)

- Lead length (from seating plane). minimum value  $\frac{+1.00}{-0.00}$  mm  $\frac{+0.040''}{-0.000''}$
- $\pm 0.25$ mm (0.010'') unless otherwise noted.

## PIN CONNECTION

PIN NO.	CONNECTION		
	A. LTS-3401L	B. LTS-3403L	C. LTS-3406L
1	No Pin	No Pin	No Pin
2	Cathode A	Anode A	Cathode B *2
3	Cathode F	Anode F	Anode H
4	Common Anode *1	Common Cathode *1	Cathode H
5	Cathode E	Anode E	Cathode G
6	Common Anode *1	Common Cathode *1	Cathode J
7	Cathode L.D.P.	Anode L.D.P.	Anode J
8	No Pin	No Pin	Cathode D.P. *3
9	No Pin	No Pin	No Pin
10	Cathode R.D.P.	Anode R.D.P.	Anode D.P.
11	Cathode D	Anode D	Cathode D.P. *3
12	Common Anode *1	Common Cathode *1	Cathode C
13	Cathode C	Anode C	Anode C
14	Cathode G	Anode G	Anode G
15	Cathode B	Anode B	Anode B
16	No Pin	No Pin	No Pin
17	Common Anode *1	Common Cathode *1	Cathode B *2
18	No Pin	No Pin	No Pin

- NOTES
- Pin 4, 6, 12 & 17 are internally connected
  - Pin 2 & 17 are internally connected.
  - Pin 8 & 11 are internally connected.

# INTERNAL CIRCUIT DIAGRAM

A. LTS-3401Lx

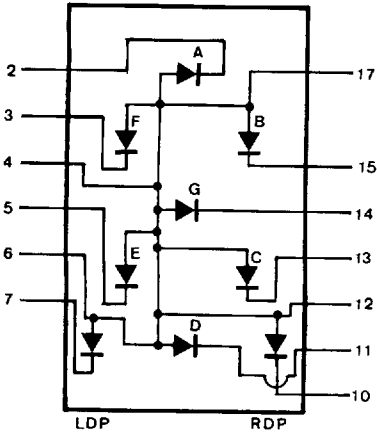

B. LTS-3403Lx

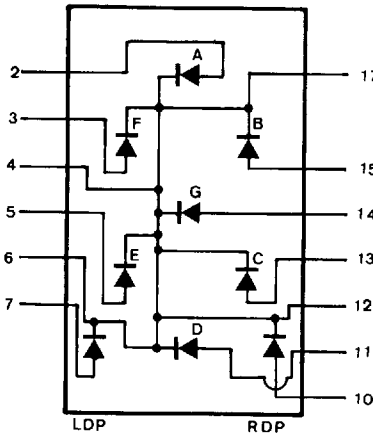

C. LTS-3406Lx

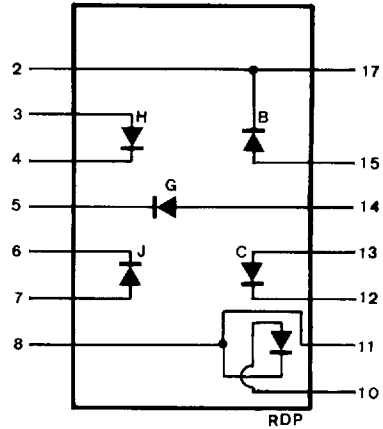

## ABSOLUTE MAXIMUM RATINGS AT $T_A = 25^\circ\text{C}$

PARAMETER	RED	BRIGHT RED	GREEN	YELLOW	HI-EFF. RED	UNIT
Power Dissipation Per Segment	55	40	75	60	75	mW
Peak Forward Current Per Segment (1/10 Duty Cycle, 0.1ms Pulse Width)	160	60	100	80	100	mA
Continuous Forward Current Per Segment	25	15	25	20	25	mA
Derating Linear From $25^\circ\text{C}$ Per Segment	0.3	0.18	0.3	0.24	0.3	mA/ $^\circ\text{C}$
Reverse Voltage Per Segment	5	5	5	5	5	V
Operating Temperature Range	- $25^\circ\text{C}$ to $+85^\circ\text{C}$					
Storage Temperature Range	- $25^\circ\text{C}$ to $+85^\circ\text{C}$					
Solder Temperature 1/16 inch Below Seating Plane for 3 Seconds at $260^\circ\text{C}$						

# ELECTRICAL/OPTICAL CHARACTERISTICS AT $T_A = 25^\circ\text{C}$

## LTS-3400LR SERIES

PARAMETER	SYMBOL	MIN.	TYP.	MAX.	UNIT	TEST CONDITION
Average Luminous Intensity	$I_v$	200	600		$\mu\text{cd}$	$I_F = 10\text{ mA}$
Peak Emission Wavelength	$\lambda_p$		655		nm	$I_F = 20\text{ mA}$
Spectral Line Half-Width	$\Delta\lambda$		24		nm	$I_F = 20\text{ mA}$
Forward Voltage, any Segment or D.P.	$V_F$		1.7	2.0	V	$I_F = 20\text{ mA}$
Reverse Current, any Segment or D.P.	$I_R$			100	$\mu\text{A}$	$V_R = 5\text{ V}$
Luminous Intensity Matching Ratio	$I_v\text{-m}$			2:1		$I_F = 20\text{ mA}$

### TYPICAL ELECTRICAL/OPTICAL CHARACTERISTIC CURVES

( $25^\circ\text{C}$  Ambient Temperature Unless Otherwise Noted)

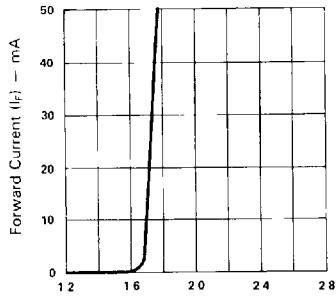

Fig 1 FORWARD CURRENT VS FORWARD VOLTAGE

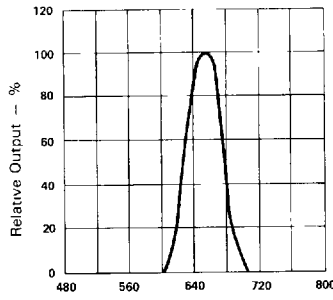

Fig 2 SPECTRAL RESPONSE

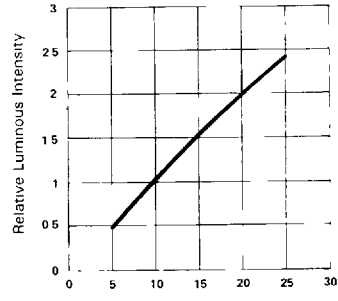

Fig 3 RELATIVE LUMINOUS INTENSITY VS FORWARD CURRENT (PER SEGMENT)

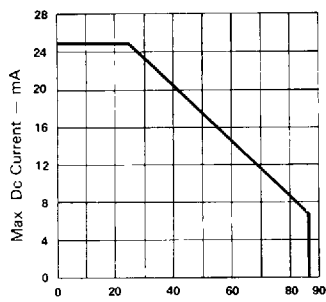

Fig 4 MAX ALLOWABLE DC CURRENT PER SEG VS AMBIENT TEMPERATURE

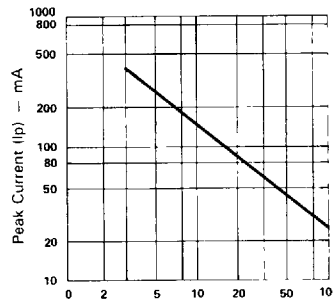

Fig 5 MAX PEAK CURRENT VS DUTY CYCLE % (REFRESH RATE -  $F = 1\text{ KHz}$ )

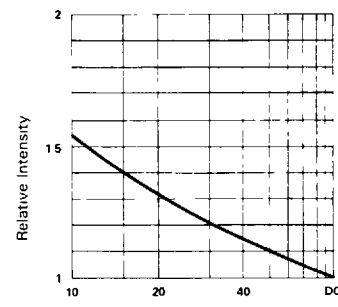

Fig 6 LUMINOUS INTENSITY VS DUTY CYCLE% (AVERAGE  $I_F = 10\text{ mA}$  PER SEG)

# ELECTRICAL/OPTICAL CHARACTERISTICS AT $T_A = 25^\circ\text{C}$

## LTS-3400LP SERIES

PARAMETER	SYMBOL	MIN.	TYP.	MAX.	UNIT	TEST CONDITION
Average Luminous Intensity	$I_v$	300	950		$\mu\text{cd}$	$I_F = 10 \text{ mA}$
Peak Emission Wavelength	$\lambda_p$		697		nm	$I_F = 20 \text{ mA}$
Spectral Line Half-Width	$\Delta\lambda$		90		nm	$I_F = 20 \text{ mA}$
Forward Voltage, any Segment or D.P.	$V_F$		2.1	2.8	V	$I_F = 20 \text{ mA}$
Reverse Current, any Segment or D.P.	$I_R$			100	$\mu\text{A}$	$V_R = 5 \text{ V}$
Luminous Intensity Matching Ratio	$I_v\text{-m}$			2:1		$I_F = 20 \text{ mA}$

### TYPICAL ELECTRICAL/OPTICAL CHARACTERISTIC CURVES

( $25^\circ\text{C}$  Ambient Temperature Unless Otherwise Noted)

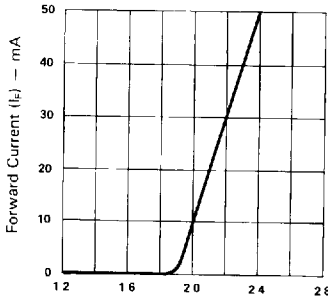

Fig. 1 FORWARD CURRENT VS FORWARD VOLTAGE

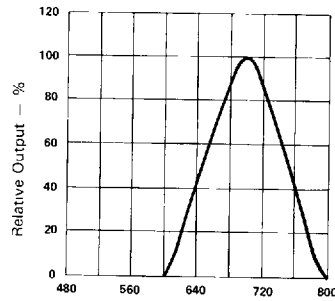

Fig. 2 SPECTRAL RESPONSE

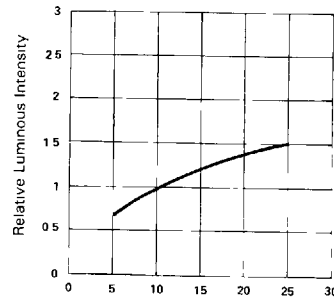

Fig. 3 RELATIVE LUMINOUS INTENSITY VS FORWARD CURRENT (PER SEGMENT)

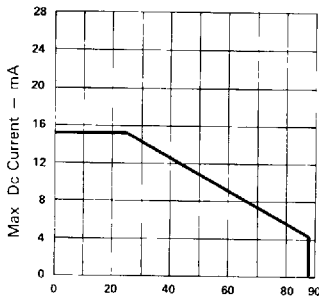

Fig. 4 MAX ALLOWABLE DC CURRENT PER SEG VS AMBIENT TEMPERATURE

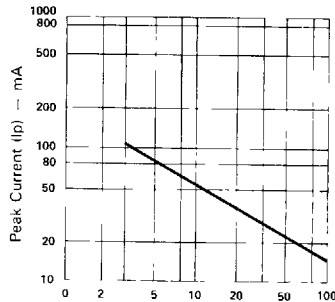

Fig. 5 MAX PEAK CURRENT VS DUTY CYCLE % (REFRESH RATE  $F = 1 \text{ KHz}$ )

SEVEN-SEGMENT LED DISPLAYS  
& ALPHANUMERIC DISPLAYS

# ELECTRICAL/OPTICAL CHARACTERISTICS AT $T_A = 25^\circ\text{C}$

## LTS-3400LG SERIES

PARAMETER	SYMBOL	MIN	TYP.	MAX	UNIT	TEST CONDITION
Average Luminous Intensity	$I_v$	800	2400		$\mu\text{cd}$	$I_f = 10\text{ mA}$
Peak Emission Wavelength	$\lambda_p$		565		nm	$I_f = 20\text{ mA}$
Spectral Line Half-Width	$\Delta\lambda$		30		nm	$I_f = 20\text{ mA}$
Forward Voltage, any Segment or D.P.	$V_f$		2.1	2.6	V	$I_f = 20\text{ mA}$
Reverse Current, any Segment or D.P.	$I_r$			100	$\mu\text{A}$	$V_r = 5\text{V}$
Luminous Intensity Matching Ratio	$I_v/m$			2:1		$I_f = 20\text{ mA}$

### TYPICAL ELECTRICAL/OPTICAL CHARACTERISTIC CURVES

( $25^\circ\text{C}$  Ambient Temperature Unless Otherwise Noted)

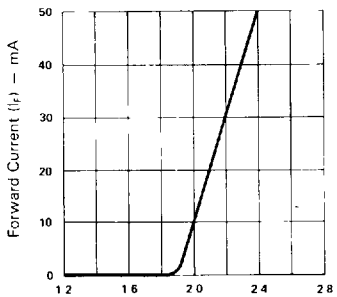

Fig 1 FORWARD CURRENT Vs FORWARD VOLTAGE

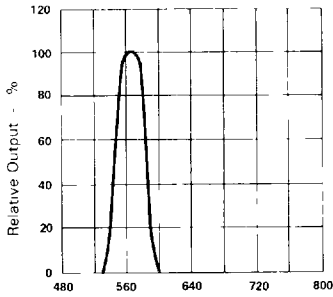

Fig 2 SPECTRAL RESPONSE

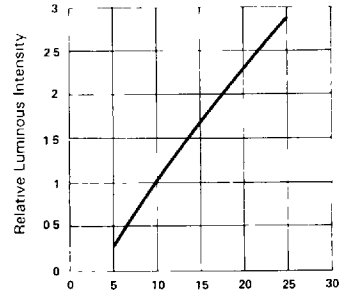

Fig 3 RELATIVE LUMINOUS INTENSITY Vs FORWARD CURRENT (PER SEGMENT)

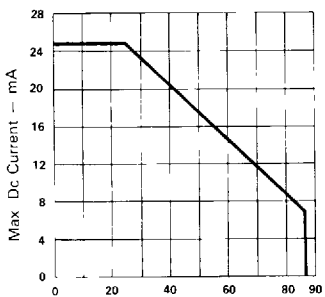

Fig 4 MAX ALLOWABLE DC CURRENT PER SEG Vs AMBIENT TEMPERATURE

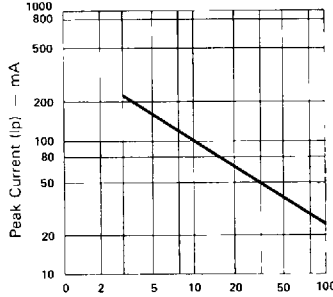

Fig 5 MAX PEAK CURRENT Vs DUTY CYCLE % (REFRESH RATE - F - 1 KHz)

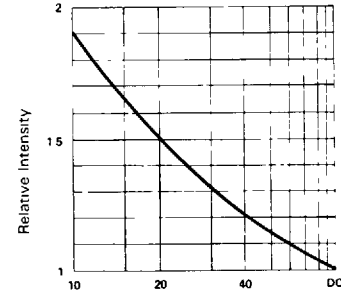

Fig 6 LUMINOUS INTENSITY Vs DUTY CYCLE % (AVERAGE  $I_f = 10\text{mA}$  PER SEG)

# ELECTRICAL/OPTICAL CHARACTERISTICS AT $T_A = 25^\circ\text{C}$

## LTS-3400LY SERIES

PARAMETER	SYMBOL	MIN.	TYP.	MAX.	UNIT	TEST CONDITION
Average Luminous Intensity	$I_v$	750	2400		$\mu\text{cd}$	$I_f = 10 \text{ mA}$
Peak Emission Wavelength	$\lambda_p$		585		nm	$I_f = 20 \text{ mA}$
Spectral Line Half-Width	$\Delta\lambda$		35		nm	$I_f = 20 \text{ mA}$
Forward Voltage, any Segment or D.P.	$V_f$		2.1	2.8	V	$I_f = 20 \text{ mA}$
Reverse Current, any Segment or D.P.	$I_R$			100	$\mu\text{A}$	$V_R = 5\text{V}$
Luminous Intensity Matching Ratio	$I_v\text{-m}$			2:1		$I_f = 20 \text{ mA}$

### TYPICAL ELECTRICAL/OPTICAL CHARACTERISTIC CURVES

( $25^\circ\text{C}$  Ambient Temperature Unless Otherwise Noted)

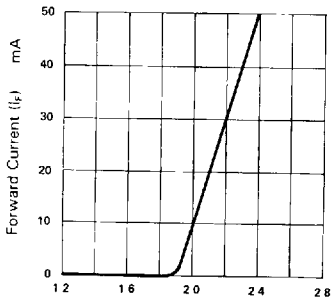

Forward Voltage ( $V_f$ ) — Volts  
Fig 1 FORWARD CURRENT Vs FORWARD VOLTAGE

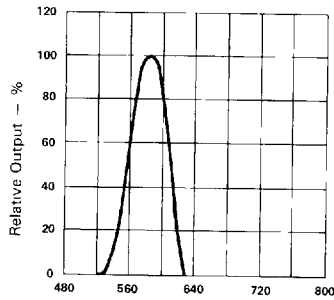

Wavelength ( $\lambda$ ) — nm  
Fig 2 SPECTRAL RESPONSE

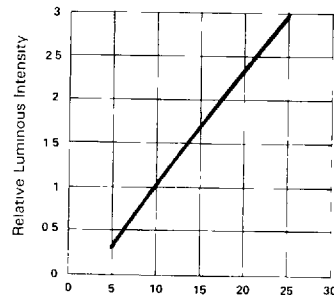

Forward Current ( $I_f$ ) — mA  
Fig 3 RELATIVE LUMINOUS INTENSITY Vs FORWARD CURRENT (PFR SEGMENT)

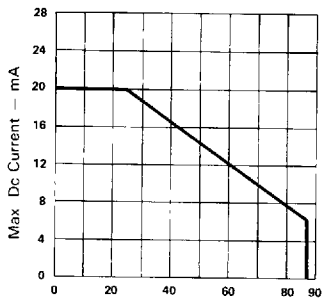

Ambient Temperature ( $T_a$ ) —  $^\circ\text{C}$   
Fig 4 MAX ALLOWABLE DC CURRENT PER SEG Vs AMBIENT TEMPERATURE

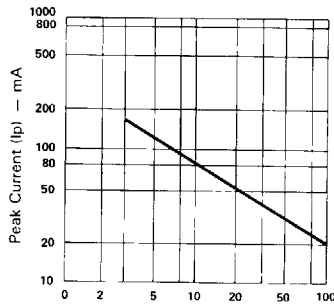

Duty Cycle %  
Fig 5 MAX PEAK CURRENT Vs DUTY CYCLE % (REFRESH RATE — F — 1 KHz)

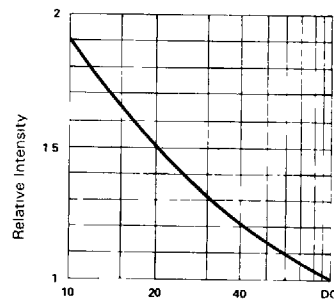

Duty Cycle %  
Fig 6 LUMINOUS INTENSITY Vs DUTY CYCLE % (AVERAGE  $I_f = 10\text{mA}$  PER SEG)

# ELECTRICAL/OPTICAL CHARACTERISTICS AT $T_A = 25^\circ\text{C}$

## LTS-3400LE SERIES

PARAMETER	SYMBOL	MIN.	TYP.	MAX.	UNIT	TEST CONDITION
Average Luminous Intensity	$I_v$	800	2400		$\mu\text{cd}$	$I_F = 10\text{ mA}$
Peak Emission Wavelength	$\lambda_p$		630		nm	$I_F = 20\text{ mA}$
Spectral Line Half-Width	$\Delta\lambda$		40		nm	$I_F = 20\text{ mA}$
Forward Voltage, any Segment or D.P.	$V_F$		2.1	2.8	V	$I_F = 20\text{ mA}$
Reverse Current, any Segment or D.P.	$I_R$			100	$\mu\text{A}$	$V_R = 5\text{V}$
Luminous Intensity Matching Ratio	$I_v\text{-m}$			2:1		$I_F = 20\text{ mA}$

### TYPICAL ELECTRICAL/OPTICAL CHARACTERISTIC CURVES

( $25^\circ\text{C}$  Ambient Temperature Unless Otherwise Noted)

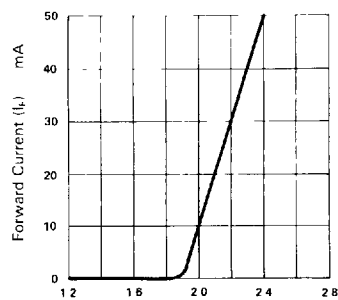

Fig 1 FORWARD CURRENT VS FORWARD VOLTAGE

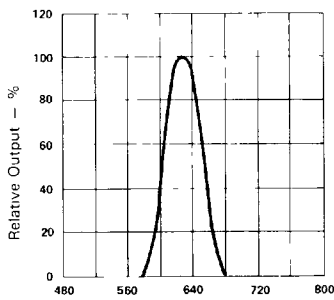

Fig 2 SPECTRAL RESPONSE

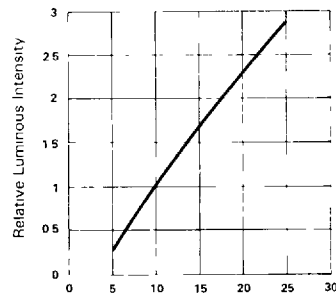

Fig 3 RELATIVE LUMINOUS INTENSITY VS FORWARD CURRENT (PER SEGMENT)

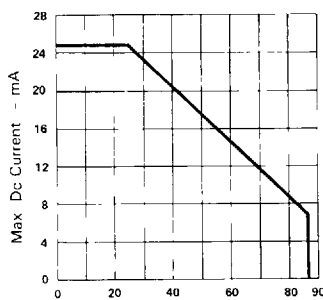

Fig 4 MAX ALLOWABLE DC CURRENT PER SEG V<sub>s</sub> AMBIENT TEMPERATURE

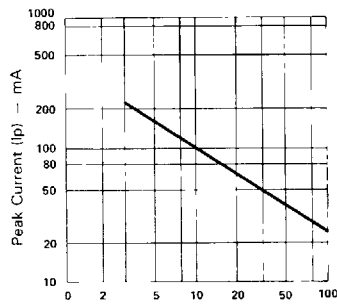

Fig 5 MAX PEAK CURRENT VS DUTY CYCLE % (REFRESH RATE - F = 1 KHz)

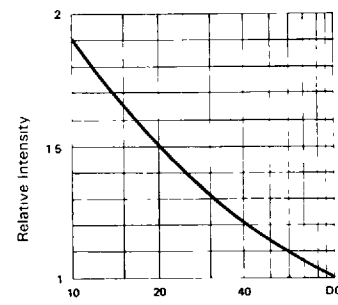

Fig 6 LUMINOUS INTENSITY VS DUTY CYCLE % (AVERAGE  $I_F = 10\text{ mA}$  PER SEG)