

### OVERVIEW

The C5122 series is a range of CB transceiver ICs fabricated using NPC's original molybdenum-gate CMOS technology. Each IC incorporates a PLL circuit, code ROM applicable to frequencies of various countries, and an UNLOCK signal generator circuit for channel switching. The IC also incorporates a built-in channel UP/DOWN control circuit and CHANNEL/PA display LED driver, thus reducing system cost.

The master slice system will make the ICs compatible with CB frequencies used all over the world, including those specified by US and British standards.

### FEATURES

- Master slice makes IC applicable to CB specifications of various nations.
- Built-in CHANNEL UP/DOWN control circuit
- Built-in UNLOCK signal generator circuit
- Built-in CHANNEL/PA display decoder
- Channel-switching check tone control output pin
- Built-in quartz crystal oscillator circuit (10.24 MHz crystal)
- Last channel backup function
- Master slice makes it possible to select between LED and LCD.
- Built-in LED driver
- Built-in amplifier for active LPF
- One crystal PLL synthesizer
- Emergency channel call function
- Power-on initialize function
- Supply voltage range 5.3 to 6.3 V
- Available in 24-pin plastic DIP or SSOP
- Molybdenum-gate CMOS construction

### PINOUT (TOP VIEW)

- 24-pin DIP

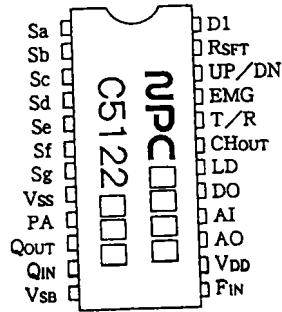

- 24-pin SSOP

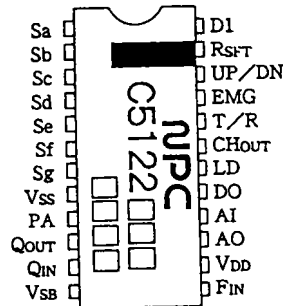

### PACKAGE DIMENSIONS

- 24-pin DIP

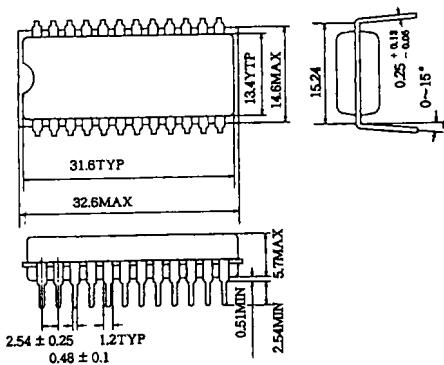

- 24-pin SSOP

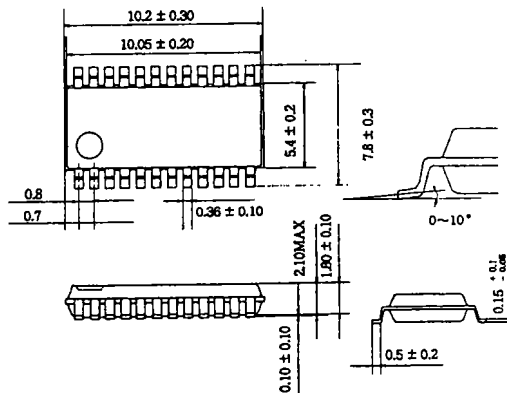

## PIN DESCRIPTION

NAME	DESCRIPTION	NAME	DESCRIPTION
Sa ~ Sg	LED segment drive outputs. Active "L"	LD	UNLOCK signal output. When unlocked, it is "L". When locked it goes "H".
VSS	Ground. Should be left "OPEN" during backup.	CHOUT	Check tone control signal output for channel-switching. Approx. 50 ms pulse is output. Active "H".
PA	PA display input. Display when H. Internal pull-down resistor	T/R	TX/RX switching input. "H" for TX, and "OPEN" for RX. Internal pull-down resistor.
QIN QOUT	Quartz crystal oscillator circuit input and output	*EMG	1 Emergency call pin. "H": Emergency channel. "OPEN": UP/DN input channel.
VSB	Ground		2 Emergency call pin. "H": Emergency CH1. "L": Emergency CH2. "OPEN": UP/DN input CH.
FIN	Programmable counter input. Internal feedback resistor.	UP/DN	UP/DN Channel UP/DOWN control input. "H": UP. "L": DOWN. "OPEN": NOP.
VDD	Power supply 5.3 to 6.3 V		
AI, AO	Lowpass filter amplifier input and output. The AI pin goes "H" during standby	RSFT	RX CODE SHIFT input. When "H", RX CODE shifts by +1. Internal pull-down resistor
DO	Phase detector output. Tristate output.	D1	LED digit drive output. When "L", low-order digits are displayed. When "H", high-order digits are displayed.

\*EMG: Two versions with different EMG functions are available.

NOP: Non operation

Function 1: C5122 □1□

Function 2: C5122□2□

## BLOCK DIAGRAM

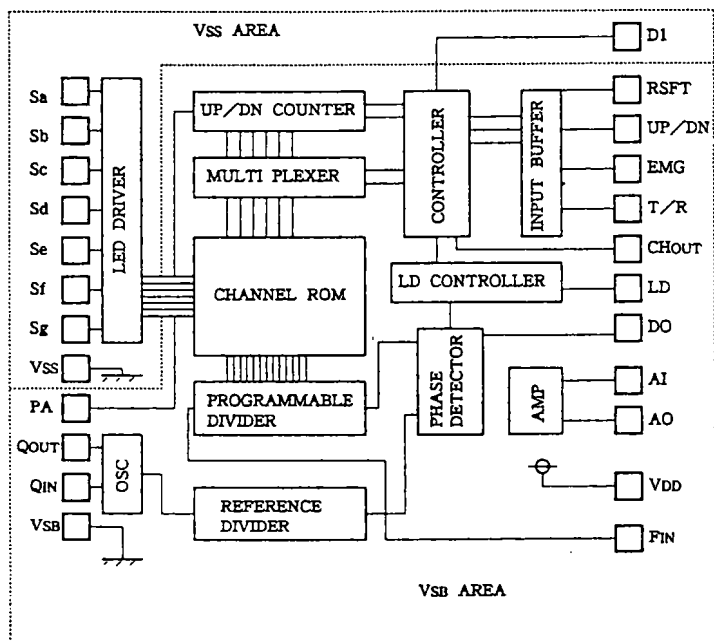

## ■ ABSOLUTE MAXIMUM RATING (SSOP)

## ■ ABSOLUTE MAXIMUM RATING (DIP)

(V<sub>SS</sub>=0V)(V<sub>SS</sub>=0V)

ITEM	SYMBOL	RATING	UNIT
Supply voltage	V <sub>DD</sub> -V <sub>SS</sub>	-0.3 to +7.0	V
Input voltage	V <sub>IN</sub>	V <sub>SS</sub> ≤V <sub>IN</sub> ≤V <sub>DD</sub>	V
Power dissipation	P <sub>w</sub>	150	mW
Operating temperature	T <sub>OPR</sub>	-30 to +80	°C
Storage temperature	T <sub>STG</sub>	-40 to +125	°C
Soldering temperature	T <sub>SLD</sub>	260±5	°C
Soldering time	t <sub>SLD</sub>	10	Sec
Maximum output current	I <sub>O</sub>	10	mA

ITEM	SYMBOL	RATING	UNIT
Supply voltage	V <sub>DD</sub> -V <sub>SS</sub>	-0.3 to +7.0	V
Input voltage	V <sub>IN</sub>	V <sub>SS</sub> ≤V <sub>IN</sub> ≤V <sub>DD</sub>	V
Power dissipation	P <sub>w</sub>	250	mW
Operating temperature	T <sub>OPR</sub>	-30 to +80	°C
Storage temperature	T <sub>STG</sub>	-40 to +125	°C
Soldering temperature	T <sub>SLD</sub>	260±5	°C
Soldering time	t <sub>SLD</sub>	10	Sec

## ■ ELECTRICAL CHARACTERISTICS

V<sub>SS</sub> = 0 V, V<sub>DD</sub> = 5.3 to 6.3 V and Ta = -30 to +80 °C unless otherwise specified.

ITEM	SYMBOL	CONDITIONS	LIMITS			UNIT	REMARKS
			MIN	TYP	MAX		
Supply voltage	V <sub>DD</sub>	F <sub>IN</sub> = F <sub>MAX</sub> /I <sub>Vp-p</sub> Q <sub>IN</sub> = 1V <sub>p-p</sub>	5.3	5.8	6.3	V	
Current consumption	I <sub>DD1</sub>	F <sub>IN</sub> = F <sub>MAX</sub> Q <sub>IN</sub> = 10.24MHz/1V <sub>p-p</sub> AI = V <sub>DD</sub>			10	mA	Max. 15 mA with DIP package
Maximum operating frequency	f <sub>MAX1</sub>	F <sub>IN</sub> = 1V <sub>p-p</sub> sine wave	18			MHz	F <sub>IN</sub>
	f <sub>MAX2</sub>	Q <sub>IN</sub> = 1V <sub>p-p</sub> sine wave	12			MHz	Q <sub>IN</sub>
Minimum operating input voltage	V <sub>IN1</sub>	F <sub>IN</sub> = F <sub>MAX</sub> sine wave	1			V <sub>p-p</sub>	F <sub>IN</sub>
	V <sub>IN2</sub>	Q <sub>IN</sub> = 10.24MHz sine wave	1			V <sub>p-p</sub>	Q <sub>IN</sub>
Input voltage	V <sub>IL1</sub>		0		0.4	V	T/R, UP/DN, PA
	V <sub>IH1</sub>		V <sub>DD</sub> -0.4		V <sub>DD</sub>	V	EMG, RSFT
Open state voltage	V <sub>IO</sub>	V <sub>DD</sub> = 5.8V Ta = 25°C	2.3	2.9	3.5	V	F <sub>IN</sub> , Q <sub>IN</sub>
Input current	I <sub>IL1</sub>	V <sub>IL1</sub> = 0V V <sub>DD</sub> = 6.3V Ta = 25°C			20	μA	F <sub>IN</sub> , Q <sub>IN</sub>
	I <sub>IH1</sub>	V <sub>IH1</sub> = V <sub>DD</sub> V <sub>DD</sub> = 6.3V Ta = 25°C			20	μA	
	I <sub>IL2</sub>	V <sub>IH2</sub> = 0V V <sub>DD</sub> = 6.3V Ta = 25°C			1	μA	T/R, PA
	I <sub>IH2</sub>	V <sub>IH2</sub> = V <sub>DD</sub> V <sub>DD</sub> = 6.3V Ta = 25°C		100	200	μA	EMG, RSFT
	I <sub>IL3</sub>	V <sub>IL3</sub> = 0V V <sub>DD</sub> = 6.3V Ta = 25°C		100	200	μA	UP/DN
	I <sub>IH3</sub>	V <sub>IH3</sub> = V <sub>DD</sub> V <sub>DD</sub> = 6.3V Ta = 25°C		100	200	μA	
Standby current	I <sub>STB</sub>	Open V <sub>SS</sub>			1	μA	V <sub>DD</sub> V <sub>SB</sub> . See typical application
Output current	I <sub>OL1</sub>	V <sub>OL</sub> = 2.0V	15			mA	Sa ~ Sg
	I <sub>OH1</sub>	V <sub>OH</sub> = V <sub>DD</sub> - 0.4V	400			μA	
	I <sub>OL2</sub>	V <sub>OL</sub> = 2.0V	1.5			mA	D1
	I <sub>OH2</sub>	V <sub>OH</sub> = V <sub>DD</sub> - 0.4V	400			μA	
	I <sub>OL3</sub>	V <sub>OL</sub> = 0.4V AI = V <sub>DD</sub>	400			μA	LD, DO
	I <sub>OH3</sub>	V <sub>OH</sub> = V <sub>DD</sub> - 0.4V AI = V <sub>SS</sub>	400			μA	CH <sub>OUT</sub> , AO

■ TYPICAL APPLICATION

• LED display

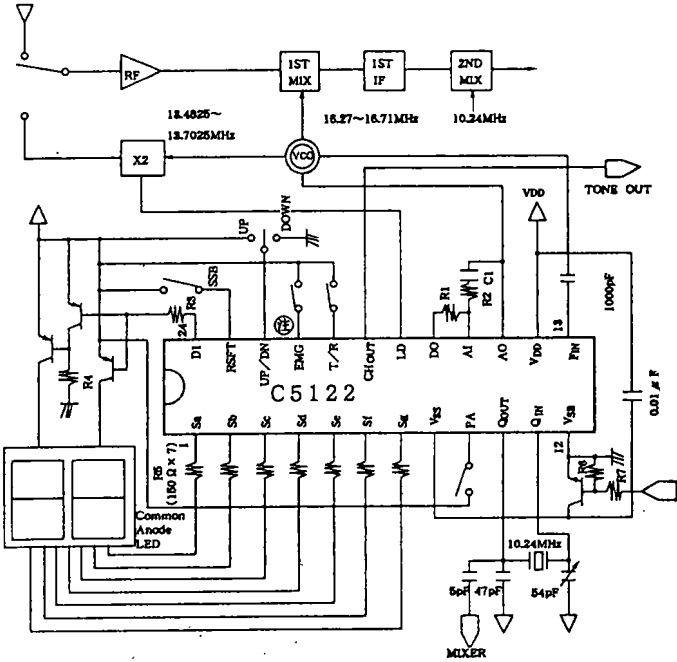

• LCD display

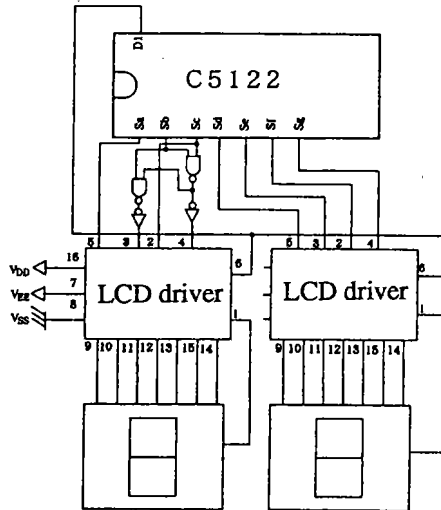

Sa ~ Sc: High-order digit data outputs (BCD)  
 Sd ~ Sg: Low-order digit data outputs (BCD)  
 D1: display drive clock 78 Hz, 50% duty

CR values are given for reference.

No values are given where nothing is specified.

Note: The circuit shown below is for the C5122 □ 2 □ version.

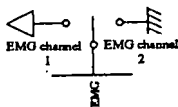

■ CHANNEL BACKUP CIRCUIT EXAMPLE

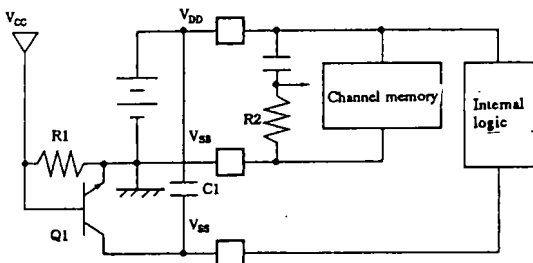

C1 = 0.01 μF. R1 and R2 are not specified.  
 A mechanical switch can be used as Q1.

■ UP/DOWN SWITCH INTERFACE

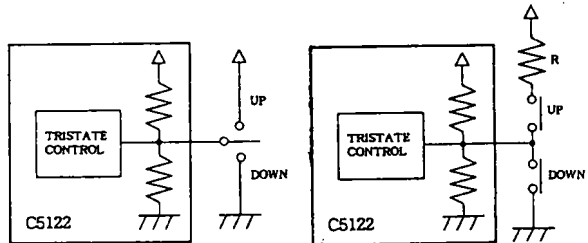

(Detent SW interface)

(Push, up/down SW interface)

R is a current limiter resistor when both are pressed simultaneously ( $R \leq 1 \text{ K}\Omega$ ). In this example, the down operation is performed when both switches are pressed simultaneously.

■ UP AND DOWN SWITCH TIMING

The UP/DOWN pin is provided for channel up/down control. In addition to step-up and step-down functions, this pin implements the fast-forward function. Holding down the key continually for wait time  $t_w$  or longer starts fast forwarding in  $t_f$  cycles. The up/down operation is disabled when the EMG, PA and T/R pins are 'H'. The up/down operation is also disabled when the Vss pin is not 'L' (during standby).

• UP/DN pin timing chart

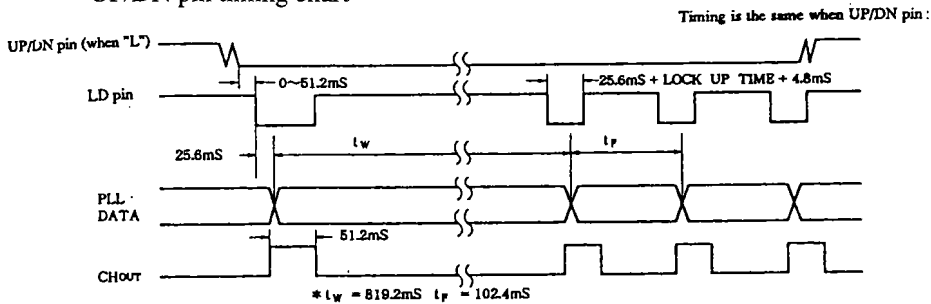

■ EMG (C5122 □ 1 □ version)

Taking the EMG pin 'H' selects the emergency channel. When 'OPEN', the channel returns to what was set by the UP/DN pin.

• EMG pin timing chart

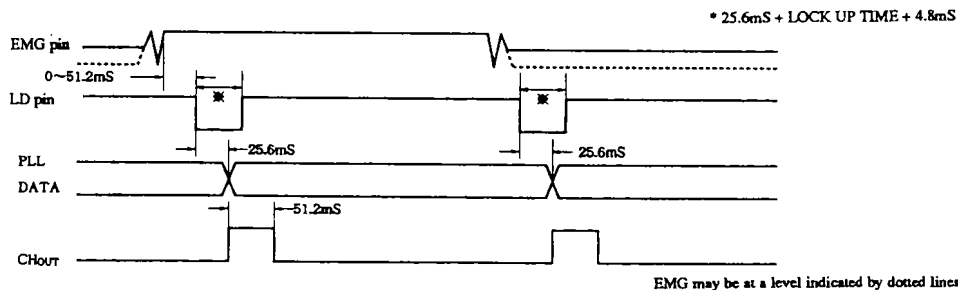

■ EMG (C5122 □ 2 □ version)

Taking the EMG pin 'H' selects emergency channel 1, and taking it 'L' selects emergency channel 2. When 'OPEN', the channel returns to what was set by the UP/DN pin.

• EMG pin timing chart (setting to emergency channel 1)

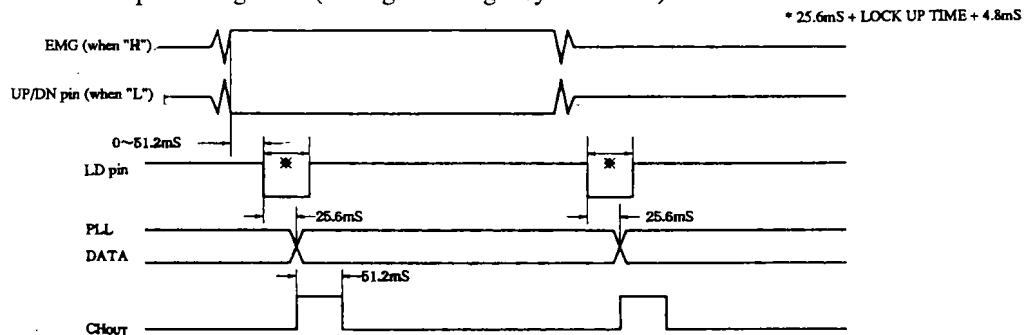

## ■ LD PIN

Unlock detector pin

The LD pin goes "H" when the PLL is locked, and goes "L" when the PLL is unlocked. The LD pin may go "L" by the UP/DN, REST, T/R or EMG pin. It may also go "L" when the PLL unlocks due to external instability.

### a. Case of input pin

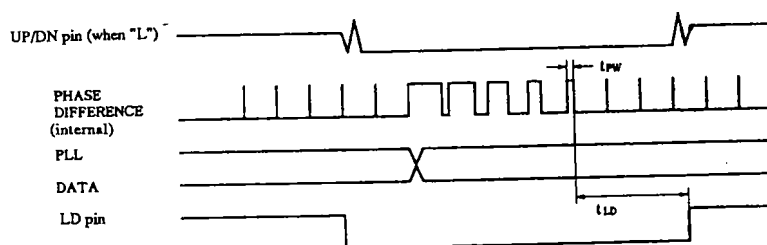

### b. Unlocking due to external instability

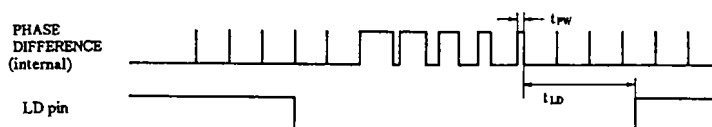

\* $t_{pw}$  ..... Phase difference (time difference) for detecting unlocking 16  $\mu\text{s}$  (TYP)

\* $t_{LD}$  .... From the time the PLL locks to produce the phase difference of 1.6  $\mu\text{s}$  until LD is reset 4.8 ms  $\pm$  10%

## ■ PA PIN

Making this pin go "H" enables PA display. Leaving it "OPEN" resumes the previous PLL operation. The PLL operation stops during PA display, and the following state is created.

- \* AI pin: "H" level
- \* CHout pin: "L" level
- \* DO pin and LD pin: High impedance
- \* Channel information is retained.

## ■ T/R pin

Transmission and receiving switching pin. The level of this pin (H/L) does not affect EMG. However, when this pin is "H", the channel up/down operation is disabled. At the time of switching, the LD pin operates in the same manner as the other input pins.

## ■ RSFT pin

Making this pin go "H" increments RX CODE by 1. Leaving it "OPEN" obtains the original CODE. The timing chart is the same as that of the EMG pin.

## ■ CHout pin

The CHOUT pin outputs signals when the channel UP/DOWN operation is performed by the UP/DN pin, when the EMG pin level changes, or when the RSFT pin level changes.

■ PRIORITY OF INPUT PINS

Data is input to UP/DN, EMG and PA pins according to the following priority: PA > EMG > UP/DN

If a high-priority pin goes "L" while a low-priority pin is in operation (e.g., from the time LD changes from H to L until the CHOUT output stops), the high-priority pin operation starts after the low-priority pin operation is finished.

With version C5122 □ 1 □ , the EMG pin may be at the level indicated by the dotted line.

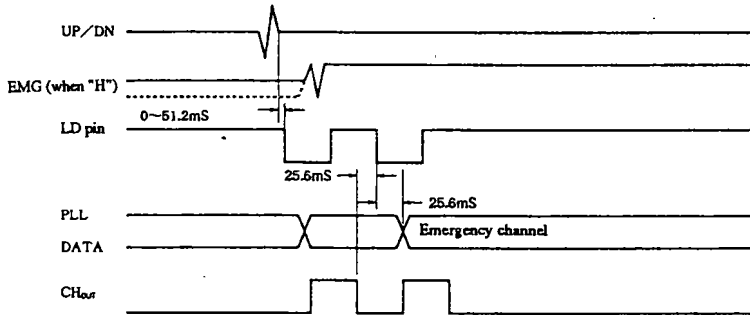

■ CHATTERING PREVENTION CIRCUIT

A chattering prevention circuit is attached to each of the UP/DN, EMG, RSFT, PA and T/R pins.

Item	Symbol	MIN	TYP	MAX	UNIT
Allowable chattering time	$t_{CH}$			51	mS
H-level input time	$t_H$	52			mS
L-level input time	$t_L$	52			mS

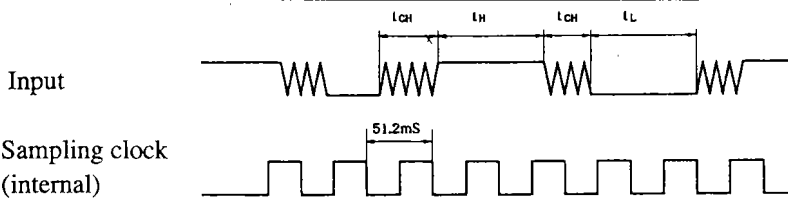

■ STANDBY MODE

Leaving the Vss pin "OPEN" sets the standby mode and performs the following operation.

- Cut off the pull-up resistor of the UP/DOWN pin.
- FIN, QIN pin: "L" level, AI pin: "H" level
- CHOUT pin: "L" level
- DO, LD pin: High impedance
- Quartz crystal oscillation is stopped.
- Channel information is retained.



\* The LD pin goes "L" when the standby state returns to the normal operation state. LD goes "H" after the PLL is locked. No signal is output from the CHOUT pin.

■ CHANNEL/PA DISPLAY

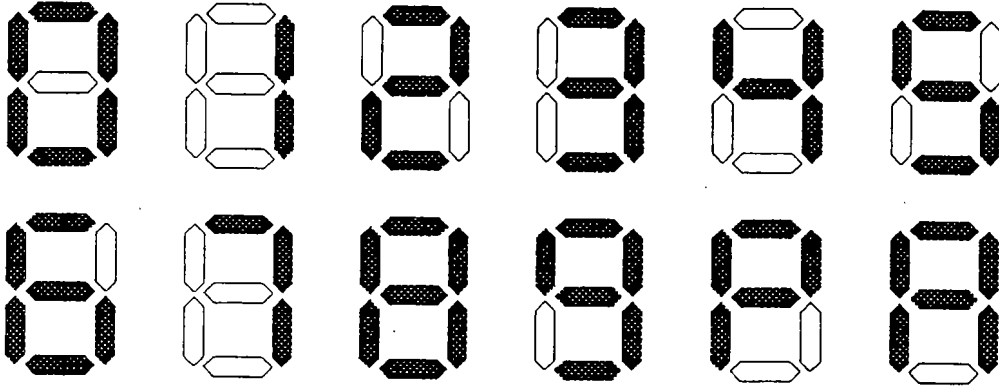
The display signals output from the Sa to Sg, D1 and PA pins display with the following display font.



● Channel display example

 : Lighting segment  
 : Non-lighting segment

1CH

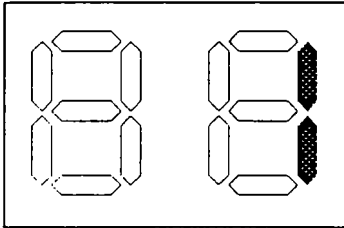

9CH

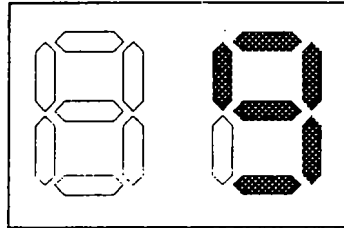

23CH

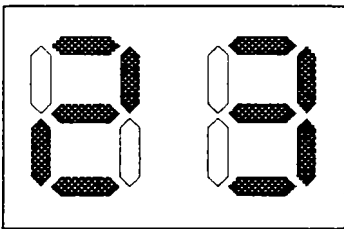

19CH

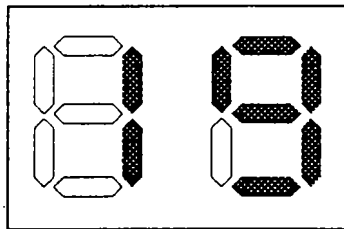

40CH

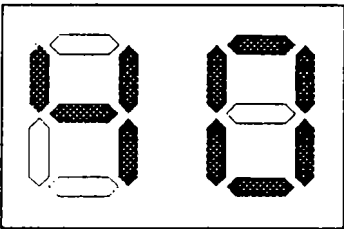

PA

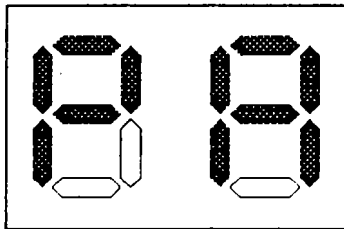



■ MASTER SLICES (example)

Version name	Frequency specification	Emergency channel	23 pin (RSFT) function	Display
C5122 A1	USA	9ch	"H"; N + 1	LED
A2	USA	9ch, 19ch	"H"; N + 1	LED
B1	UK	9ch	NC	LED
⋮	⋮	⋮	⋮	⋮
E1	DENMARK, NORWAY	11Ach	"H"; N + 1	LED
⋮	⋮	⋮	⋮	⋮
J1	USA	9ch	"H"; N + 1	LCD

■ VERSION NAME

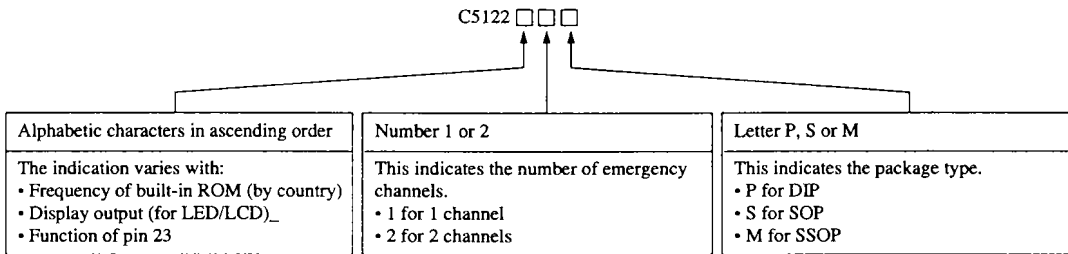

■ FREQUENCY TABLE (reference)

(Unit: MHz)

CHANNEL	USA			CHANNEL	USA		
	FREQ	TX VCO FREQ (TX F IN)	TX VCO FREQ (RX F IN)		FREQ	TX VCO FREQ (TX F IN)	RX VCO FREQ (RX F IN)
1	26.965	13.5825	16.27	21	27.215	13.6075	16.52
2	26.975	13.4875	16.28	22	27.225	13.6125	16.53
3	26.985	13.4925	16.29	23	27.255	13.6275	16.56
4	27.005	13.5025	16.31	24	27.235	13.6175	16.54
5	27.015	13.5075	16.32	25	27.245	13.6225	16.55
6	27.025	13.5125	16.33	26	27.265	13.6325	16.57
7	27.035	13.5175	16.34	27	27.275	13.6375	16.58
8	27.055	13.5275	16.36	28	27.285	13.6425	16.59
9	27.065	13.5325	16.37	29	27.295	13.6475	16.60
10	27.075	13.5375	16.38	30	27.305	13.6525	16.61
11	27.085	13.5425	16.39	31	27.315	13.6575	16.62
12	27.105	13.5525	16.41	32	27.325	13.6625	16.63
13	27.115	13.5575	16.42	33	27.335	13.6675	16.64
14	27.125	13.5625	16.43	34	27.345	13.6725	16.65
15	27.135	13.5675	16.44	35	27.355	13.6775	16.66
16	27.155	13.5775	16.46	36	27.365	13.6825	16.67
17	27.165	13.5825	16.47	37	27.375	13.6875	16.68
18	27.175	13.5875	16.48	38	27.385	13.6925	16.69
19	27.185	13.5925	16.49	39	27.395	13.6975	16.70
20	27.205	13.6025	16.51	40	27.405	13.7025	16.71