

■ OUTLINE

The R1140Q Series are voltage regulator ICs with high output voltage accuracy, low supply current, low ON-resistance, and high ripple rejection by CMOS process. Each of these voltage regulator ICs consists of a voltage reference unit, an error amplifier, resistors for setting Output Voltage, a current limit circuit, and a chip enable circuit.

These ICs perform with low dropout voltage and a chip enable function. The line transient response and load transient response of the R1140Q Series are excellent, thus these ICs are very suitable for the power supply for hand-held communication equipment.

The output voltage of these ICs is internally fixed with high accuracy. Since the package for these ICs are SC-82AB (Super Mini-mold) package, high density mounting of the ICs on boards is possible.

■ FEATURES

- Ultra-Low Supply Current..... TYP. 75 μ A
- Standby Mode TYP. 0.1 μ A
- Low Dropout Voltage TYP. 0.15V($I_{OUT}=100$ mA Output Voltage=3.0V Type)
- High Ripple Rejection TYP. 75dB($f=1$ kHz)
- Low Temperature-Drift Coefficient of Output Voltage TYP. ± 100 ppm/ $^{\circ}$ C
- Excellent Line Regulation TYP. 0.05%/V
- High Output Voltage Accuracy..... $\pm 2.0\%$
- Excellent Dynamic Response
- Small PackageSC-82AB(Super Mini-mold)
- Output Voltage.....Stepwise setting with a step of 0.1V in the range of 1.5V to 4.0V is possible
- Built-in chip enable circuit (B/D: active high)
- Built-in fold-back protection circuit.....TYP. 40mA (Current at short mode)

■ APPLICATIONS

- Power source for cellular phones such as GSM, CDMA and various kinds of PCS.
- Power source for electrical appliances such as cameras, VCRs and camcorders.
- Power source for battery-powered equipment.

■ BLOCK DIAGRAM

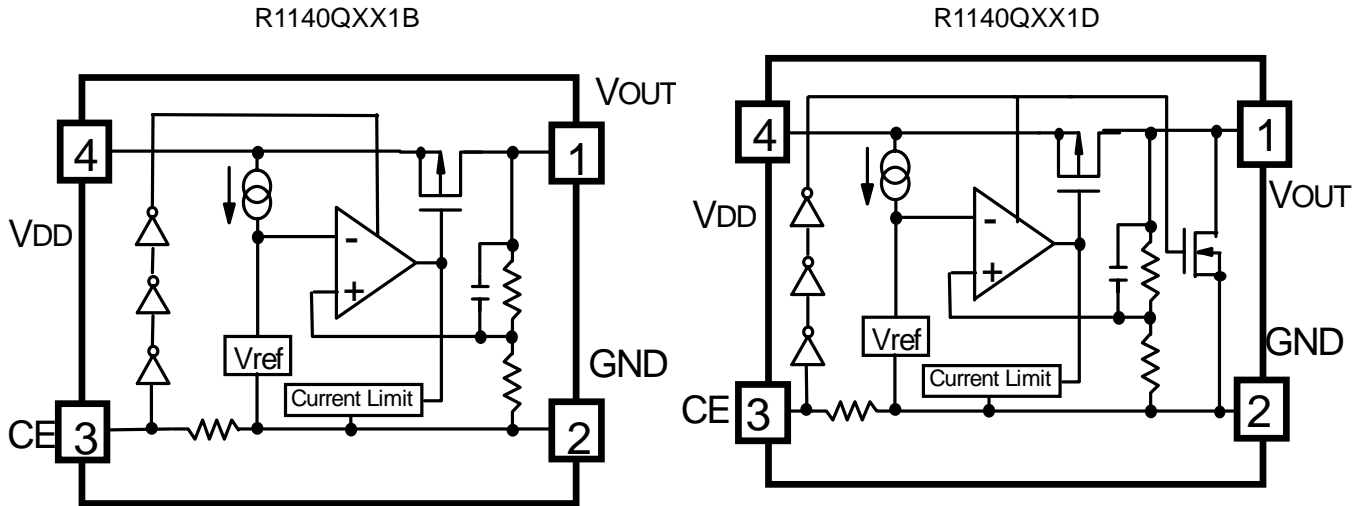

■ SELECTION GUIDE

The output voltage, mask option, and the taping type for the ICs can be selected at the user's request. The selection can be made by designating the part number as shown below;

R1140QXX1X-XX ←Part Number
 ↑ ↑ ↑ ↑
 a b c d

Code	Contents
a	Designation of Package Type : N:SOT-23-5 (Mini-mold)
b	Setting Output Voltage (V_{OUT}) : Stepwise setting with a step of 0.1V in the range of 1.5V to 4.0V is possible.
c	Designation of Mask Option : B: Without Nch Tr. for discharge at OFF state. D: With Nch Tr. for discharge at OFF state.
d	Designation of Taping Type : Ex. TR, TL (refer to Taping Specifications; TR type is the standard direction.)

■ PIN CONFIGURATION

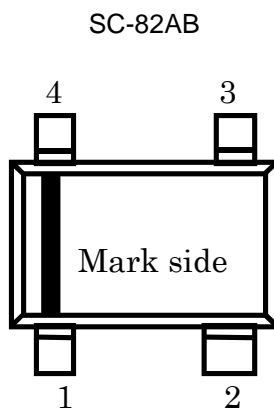

■ PIN DESCRIPTION

Pin No.	Symbol	Description
1	V_{OUT}	Output pin
2	GND	Ground Pin
3	CE	Chip Enable Pin
4	V_{DD}	Input Pin

■ ABSOLUTE MAXIMUM RATINGS

Item	Symbol	Rating	Unit
Input Voltage	V_{IN}	6.5	V
Input Voltage(CE Pin)	V_{CE}	-0.3 ~ $V_{IN}+0.3$	V
Output Voltage	V_{OUT}	-0.3 ~ $V_{IN}+0.3$	V
Output Current	I_{OUT}	140	mA
Power Dissipation	P_D	150	mW
Operating Temperature Range	T_{opt}	-40 ~ 85	°C
Storage Temperature Range	T_{stg}	-55 ~ 125	°C

ELECTRICAL CHARACTERISTICS

R1140QXX1B/R1140QXX1D

Topt=25°C

Symbol	Item	Conditions	MIN.	TYP.	MAX.	Unit
V _{OUT}	Output Voltage	V _{IN} = Set V _{OUT} +1V 1mA ≤ I _{OUT} ≤ 30mA	V _{OUT} ×0.98		V _{OUT} ×1.02	V
I _{OUT}	Output Current	V _{IN} - V _{OUT} = 1.0V	120			mA
ΔV _{OUT} /ΔI _{OUT}	Load Regulation	V _{IN} = Set V _{OUT} +1V 1mA ≤ I _{OUT} ≤ 120mA		12	40	mV
V _{DIF}	Dropout Voltage	Refer to the ELECTRICAL CHARACTERISTICS by OUTPUT VOLTAGE				
I _{SS}	Supply Current	V _{IN} = Set V _{OUT} +1V		75	150	μA
I _{standby}	Supply Current (Standby)	V _{IN} = V _{CE} = Set V _{OUT} +1V		0.1	1.0	μA
ΔV _{OUT} /ΔV _{IN}	Line Regulation	Set V _{OUT} +0.5V ≤ V _{IN} ≤ 6V I _{OUT} = 30mA (In case that V _{OUT} ≤ 1.6V, 2.2V ≤ V _{IN} ≤ 6V)		0.05	0.20	%/V
RR	Ripple Rejection	f = 1kHz, Ripple 0.5Vp-p V _{IN} = Set V _{OUT} +1V, I _{OUT} = 30mA		75		dB
V _{IN}	Input Voltage		2.2		6.0	V
ΔV _{OUT} /ΔT	Output Voltage Temperature Coefficient	I _{OUT} = 30mA -40°C ≤ Topt ≤ 85°C		±100		ppm /°C
I _{lim}	Short Current Limit	V _{OUT} = 0V		40		mA
R _{PU}	CE Pull-up Resistance		1.5	4	16	MΩ
V _{CEH}	CE Input Voltage "H"		1.5		V _{IN}	V
V _{CEL}	CE Input Voltage "L"		0.0		0.3	V
e _n	Output Noise	BW=10Hz to 100kHz		30		μVrms
R _{LOW}	Low Output Nch Tr. ON Resistance (of D version)	V _{CE} =0V		70		Ω

ELECTRICAL CHARACTERISTICS by OUTPUT VOLTAGE

Topt = 25°C

Output Voltage V _{OUT} (V)	Dropout Voltage		
	V _{DIF} (V)		
	Condition	TYP.	MAX.
1.5 ≤ V _{OUT} ≤ 1.6	I _{OUT} = 120mA	0.36	0.70
1.7 ≤ V _{OUT} ≤ 1.8		0.30	0.50
1.9 ≤ V _{OUT} ≤ 2.0		0.28	0.45
2.1 ≤ V _{OUT} ≤ 2.7		0.24	0.40
2.8 ≤ V _{OUT} ≤ 4.0		0.18	0.30

TECHNICAL NOTES

When using these ICs, consider the following points:

Phase Compensation

In these ICs, phase compensation is made for securing stable operation even if the load current is varied. For this purpose, be sure to use a 2.2 μ F or more capacitor C_{OUT} with good frequency characteristics and ESR (Equivalent Series Resistance). (Note: When the additional ceramic capacitors are connected to the Output Pin with Output capacitor for phase compensation, the operation might be unstable. Because of this, test these ICs with as same external components as ones to be used on the PCB.)

PCB Layout

Make VDD and GND line sufficient. When the impedance of these is high, it would be a cause of picking up the noise or unstable operation. Connect a capacitor with as much as 1.0 μ F capacitor between VDD and GND pin as close as possible. Set external components, especially output capacitor as close as possible to the ICs and make wiring shortest.

TEST CIRCUITS

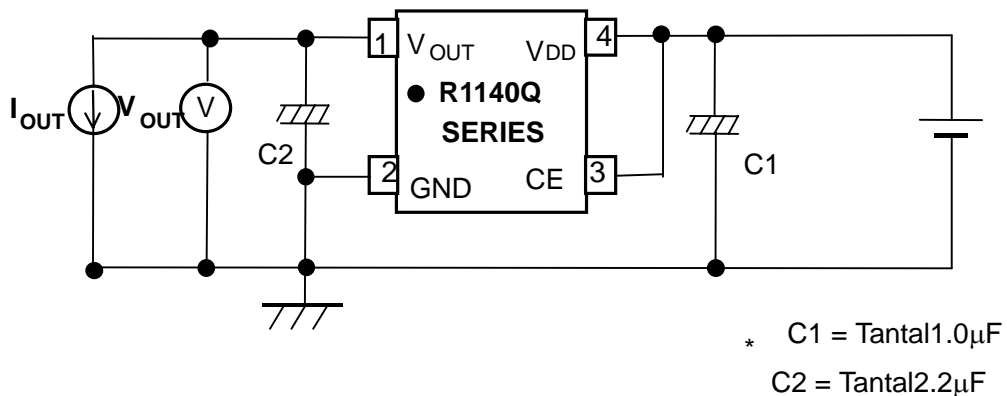

Fig.1 Standard test Circuit

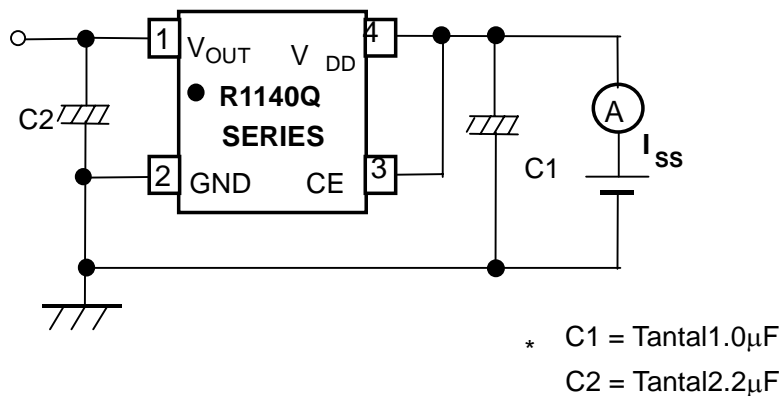

Fig.2 Supply Current Test Circuit

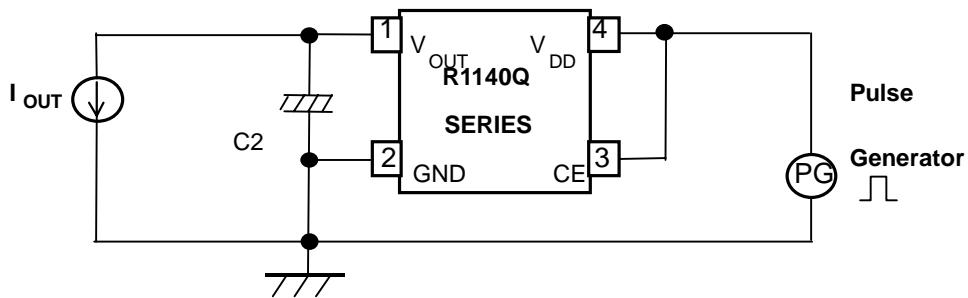

Fig.3 Ripple Rejection, Line Transient Response Test Circuit

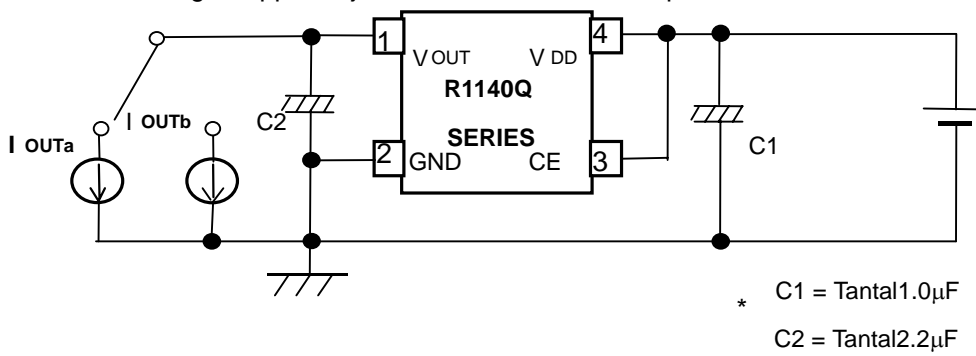
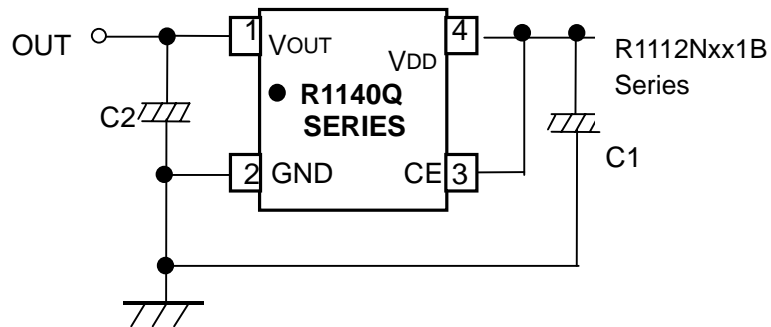

Fig.4 Load Transient Response Test Circuit

■ TYPICAL APPLICATION



(External Components)
Output Capacitor; Tantalum Type

TYPICAL CHARACTERISTICS

1) Output Voltage vs. Output Current

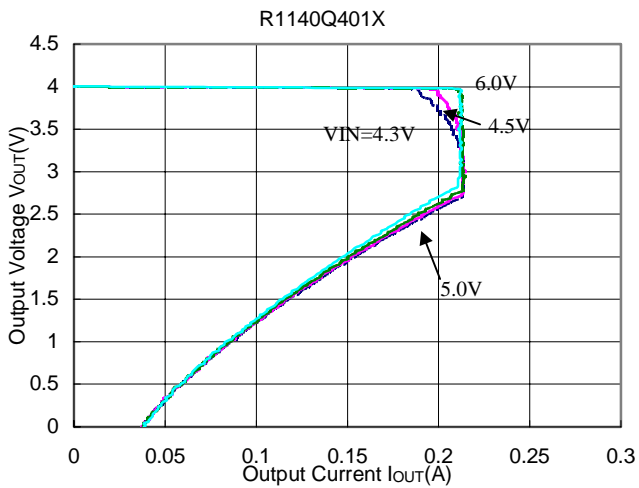
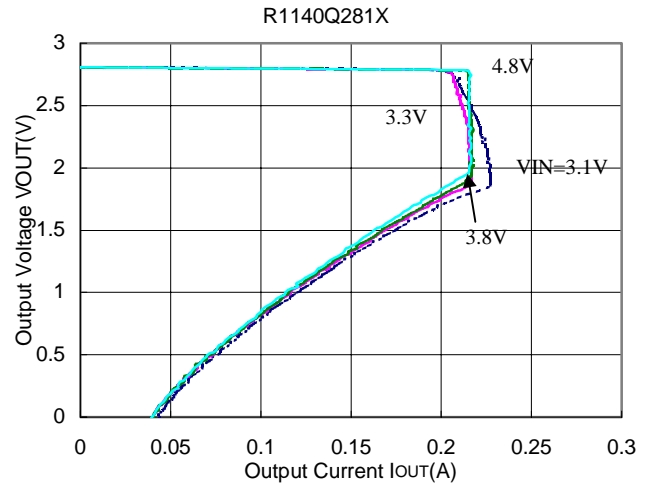
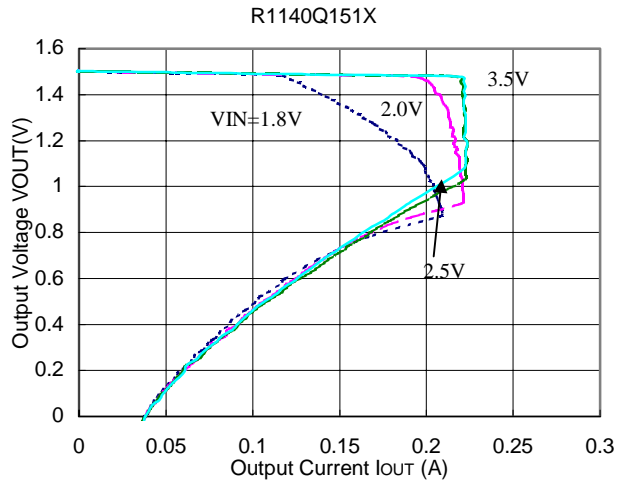

2) Output Voltage vs. Input Voltage

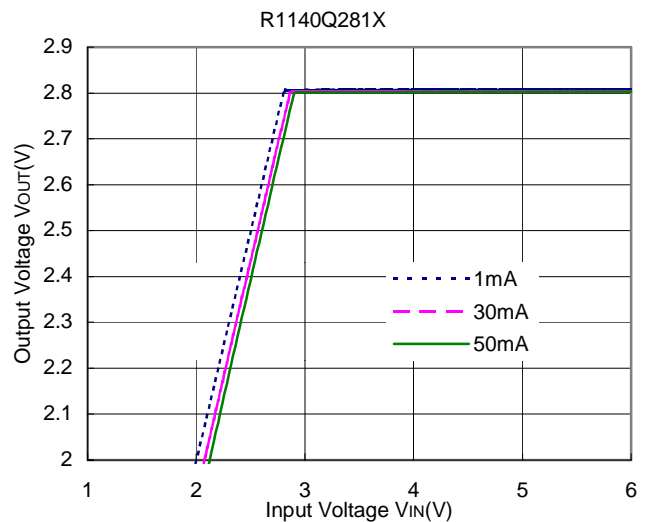
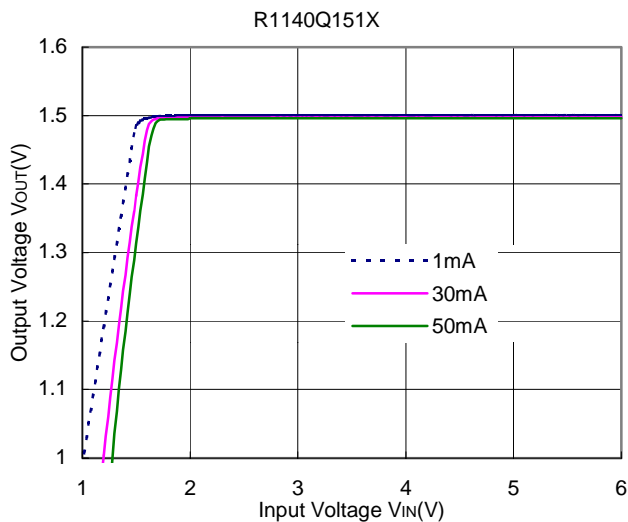

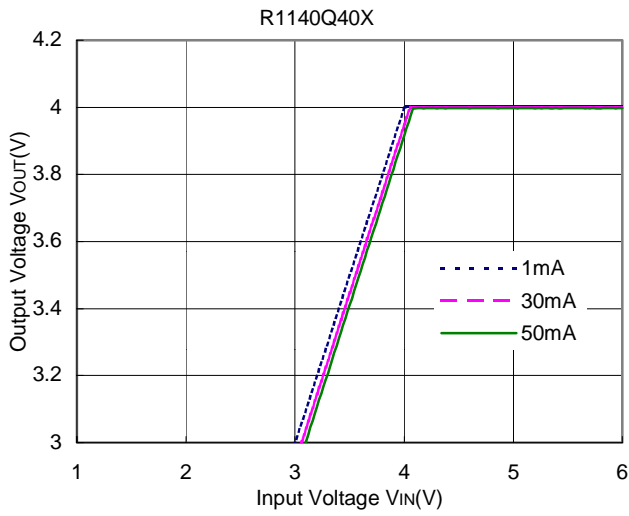

3) Dropout Voltage vs. Output Current

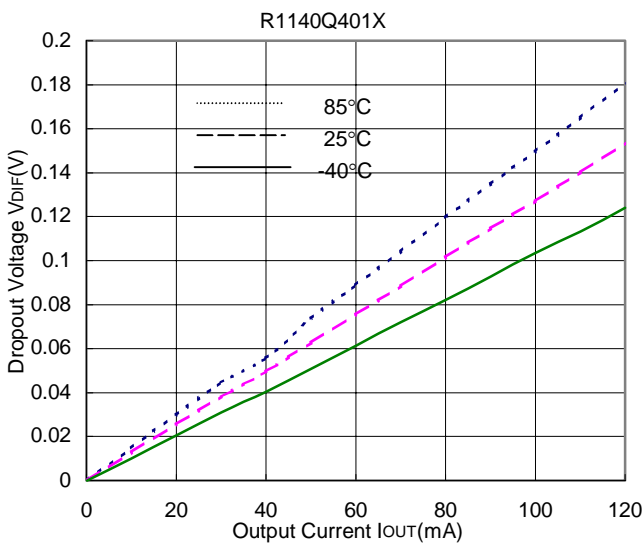
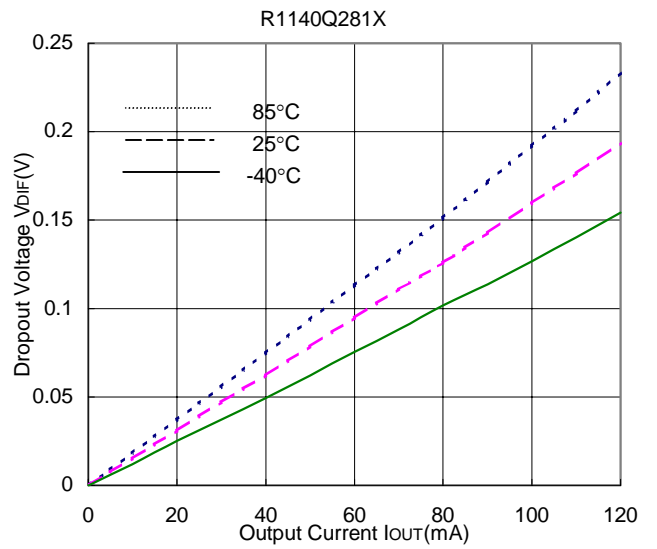
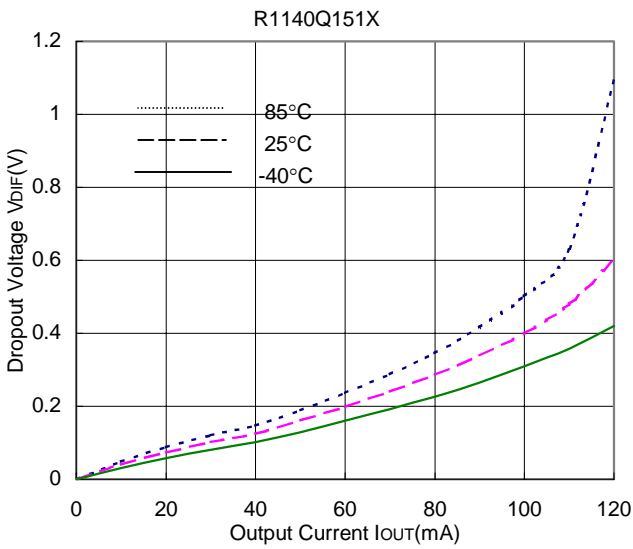

4) Output Voltage vs. Temperature

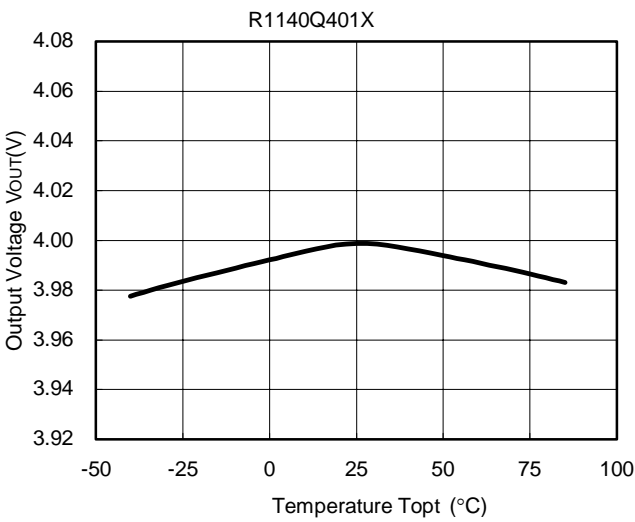
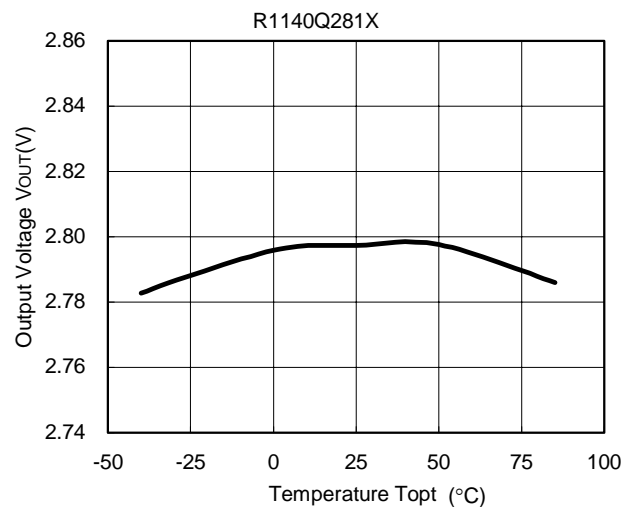
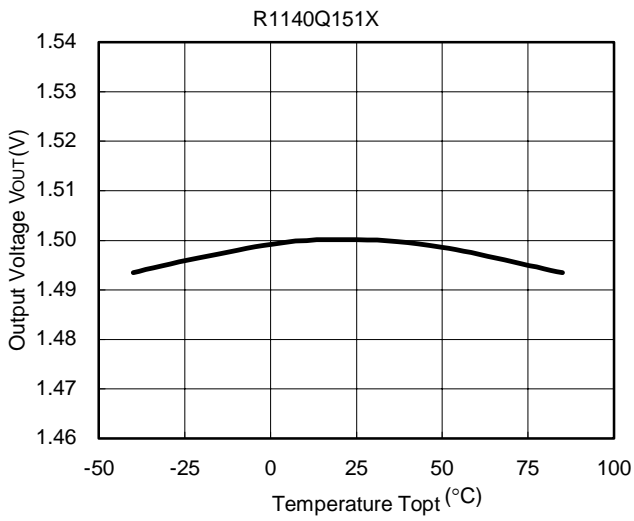

5) Supply Current vs. Input Voltage

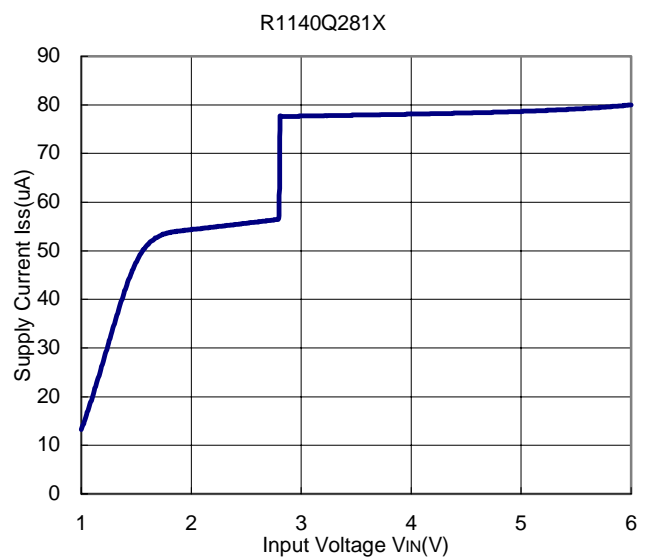
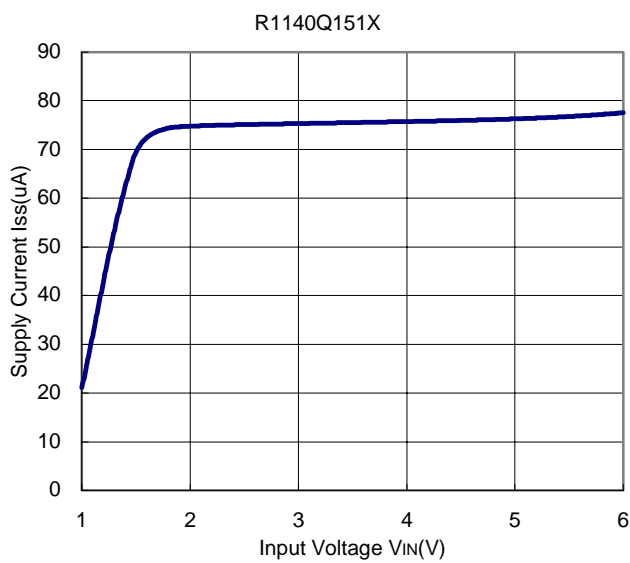

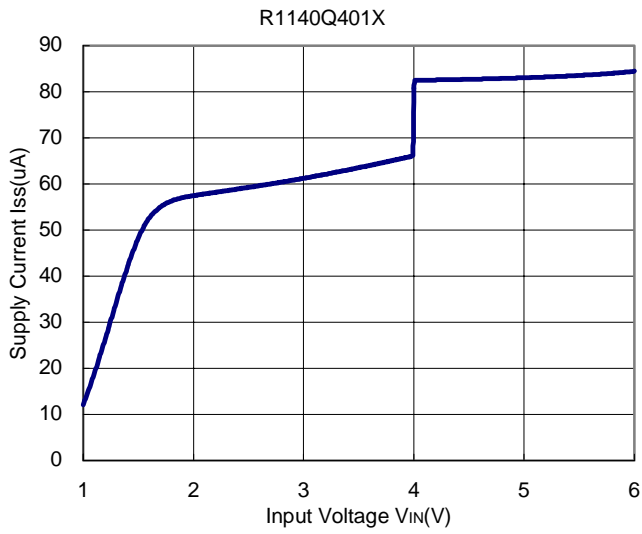

6) Supply Current vs. Temperature

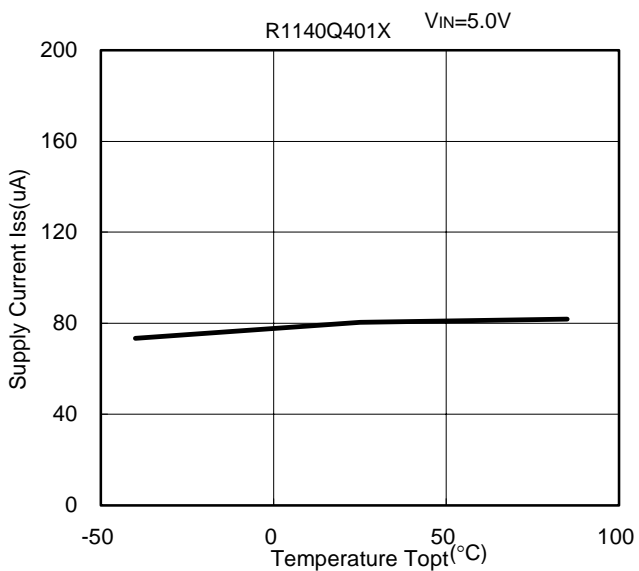
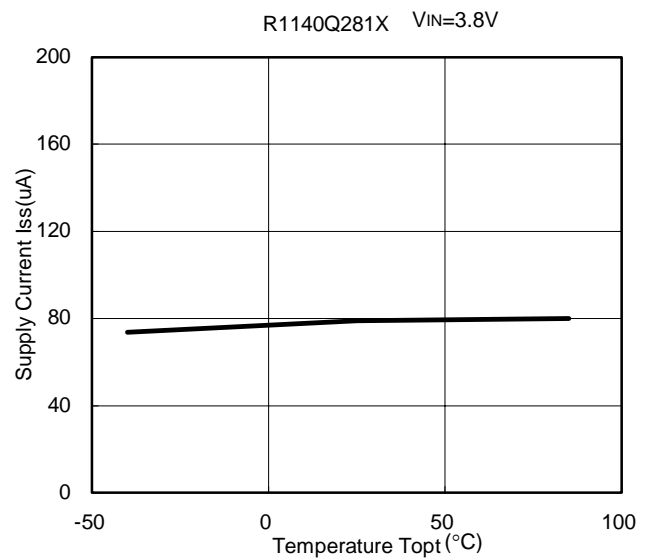
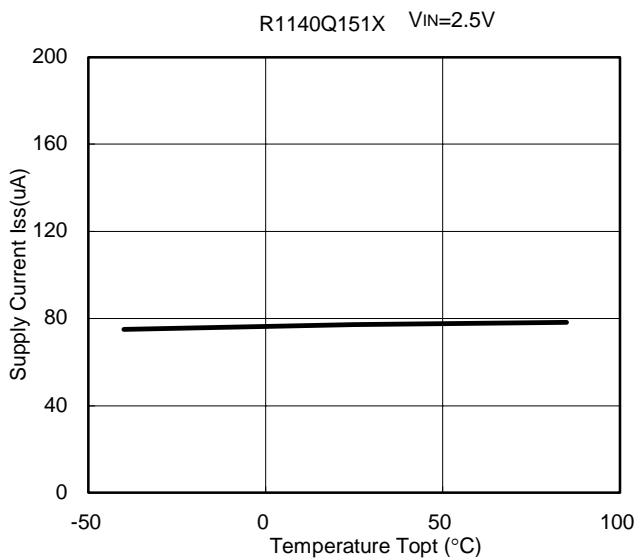

7) Dropout Voltage vs. Set Output Voltage

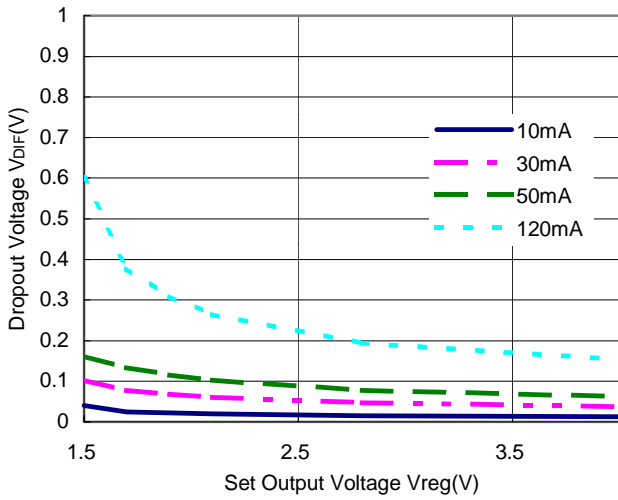

8) Ripple Rejection vs. Frequency

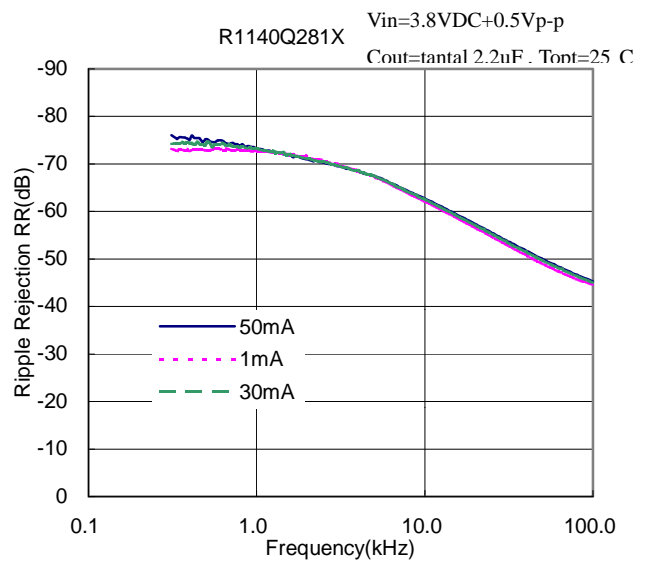
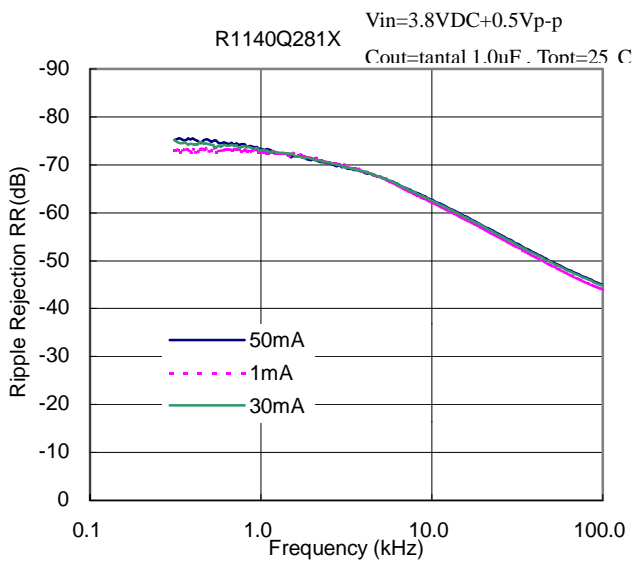
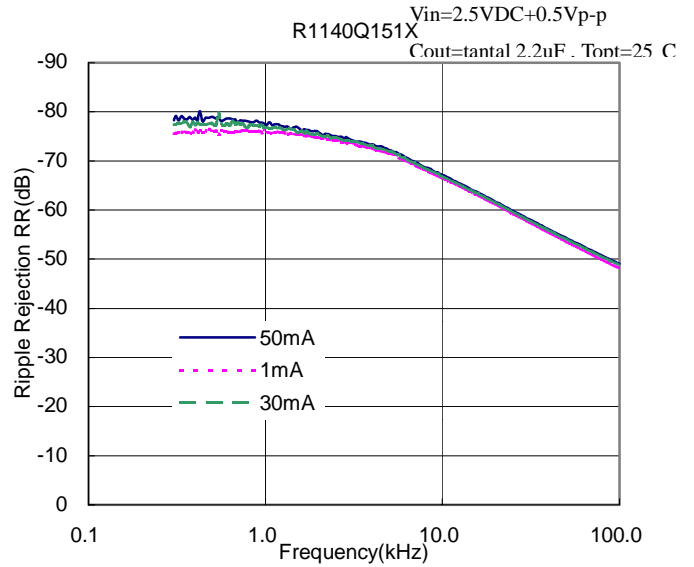
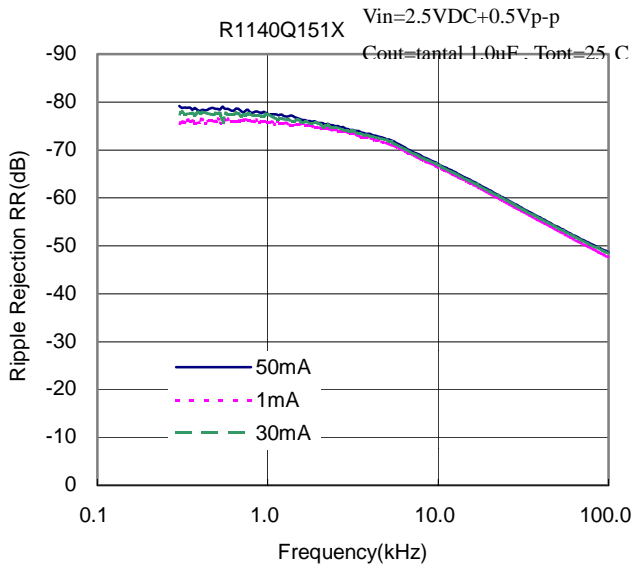

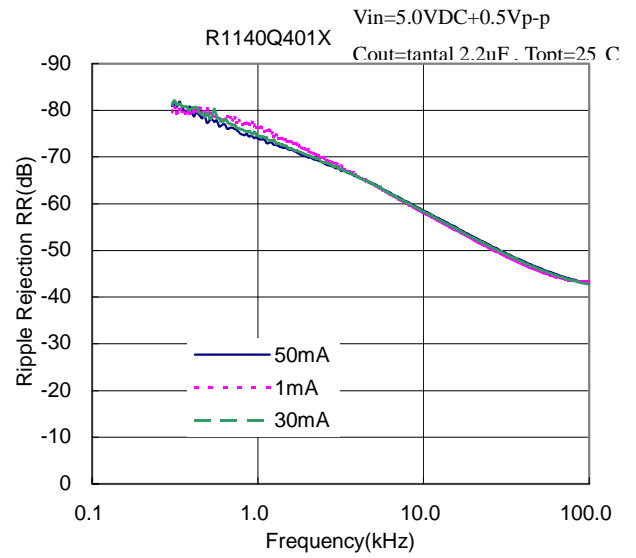
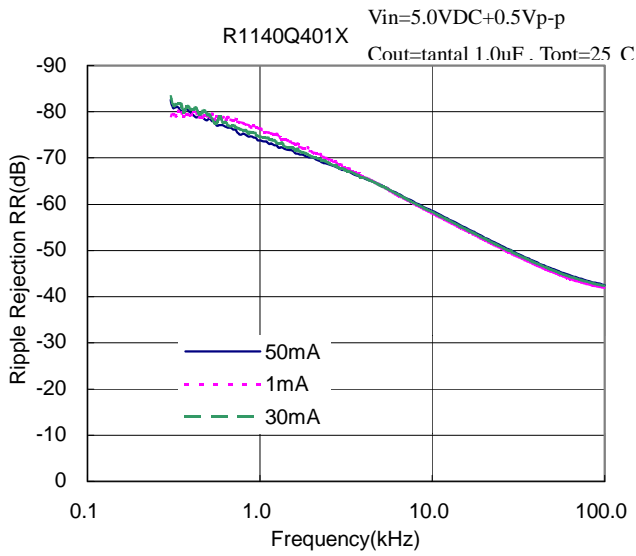

9) Ripple Rejection vs. Input Bias

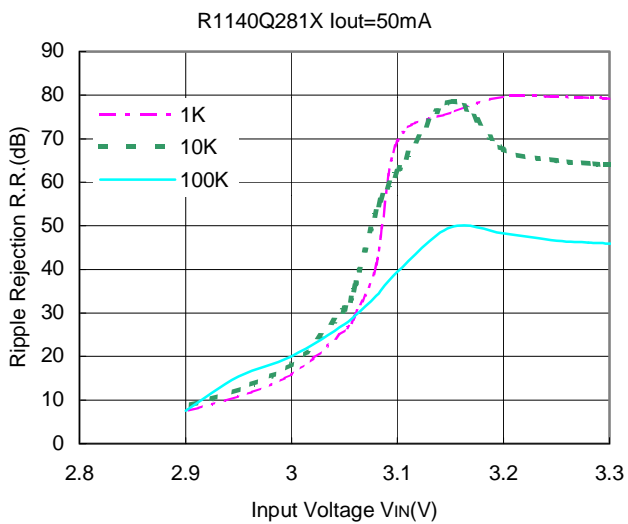
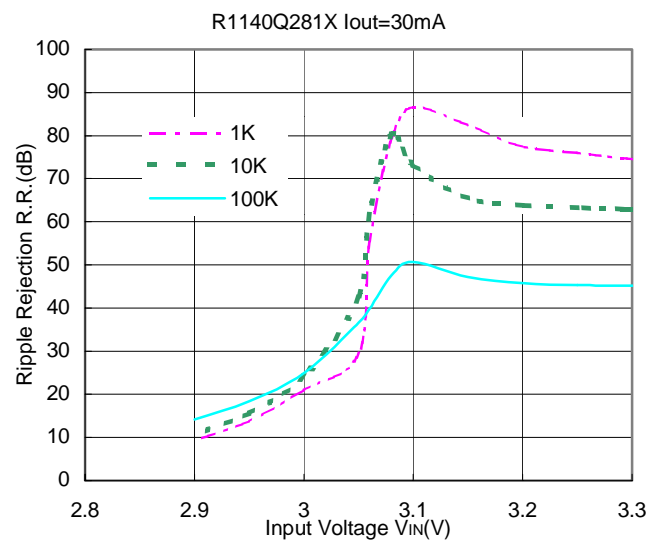
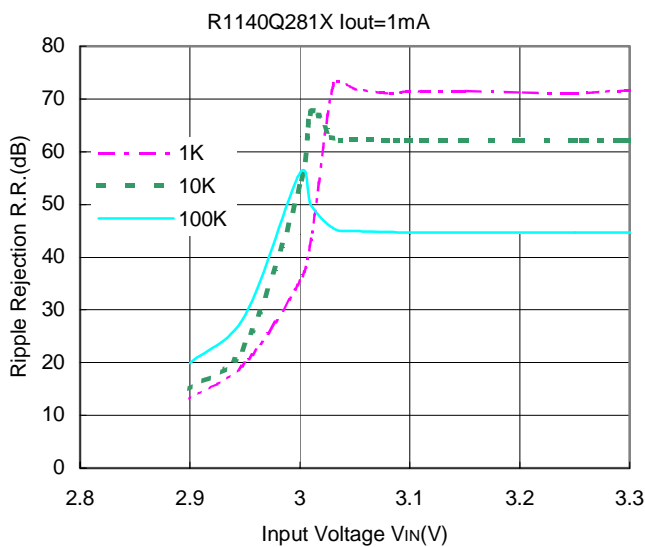

10) Input Transient Response

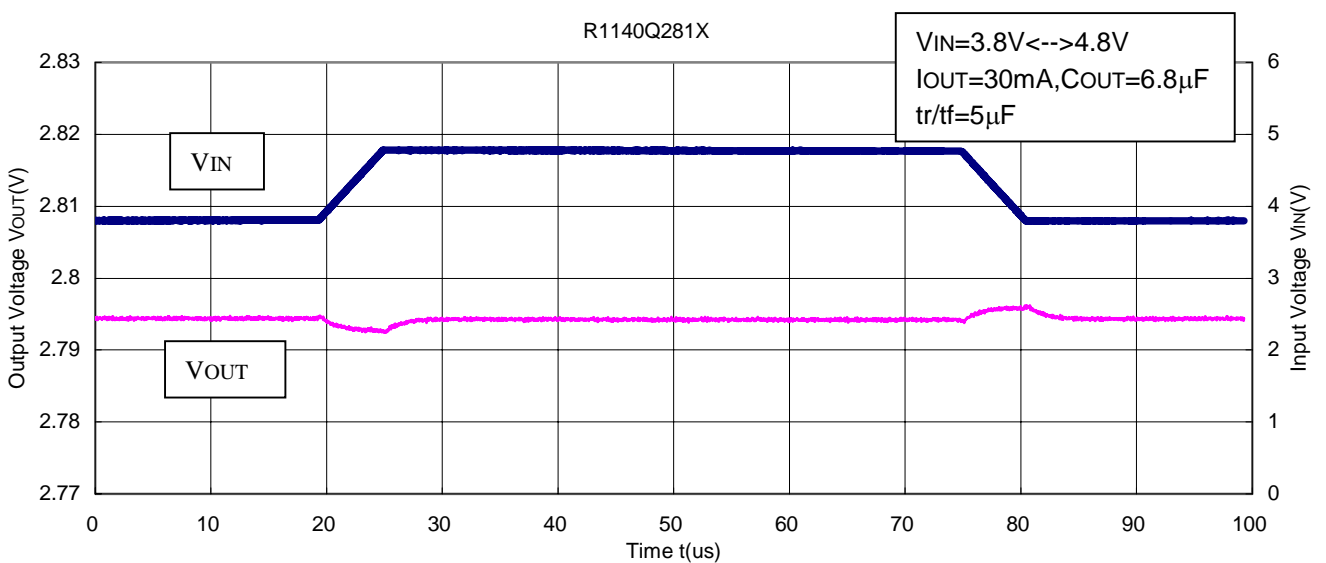
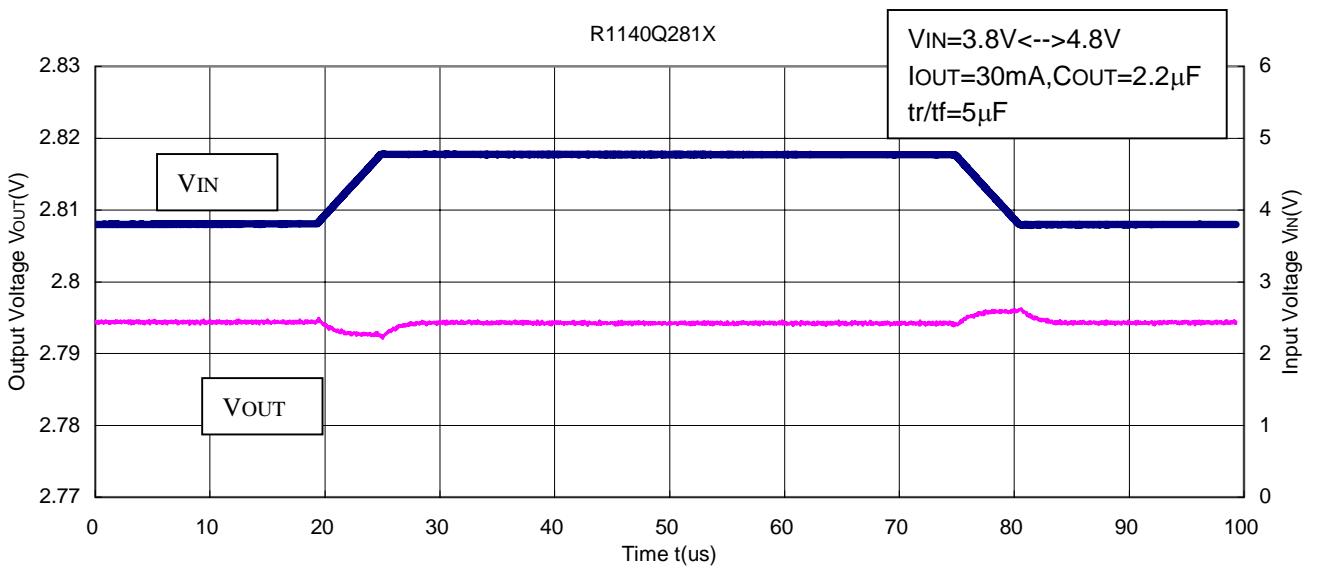
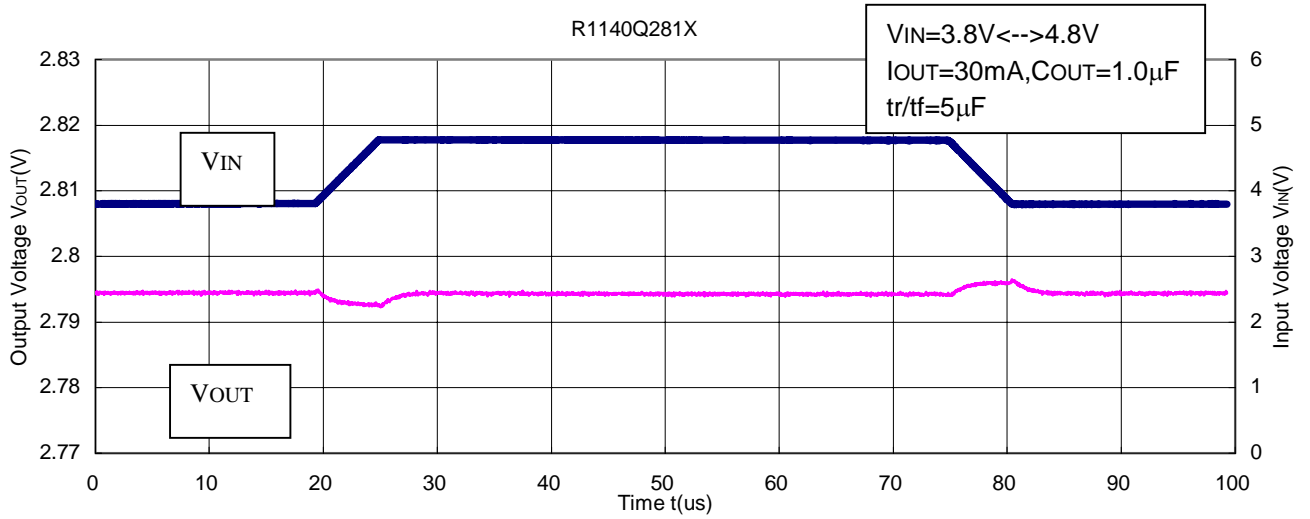

11) Load Transient Response

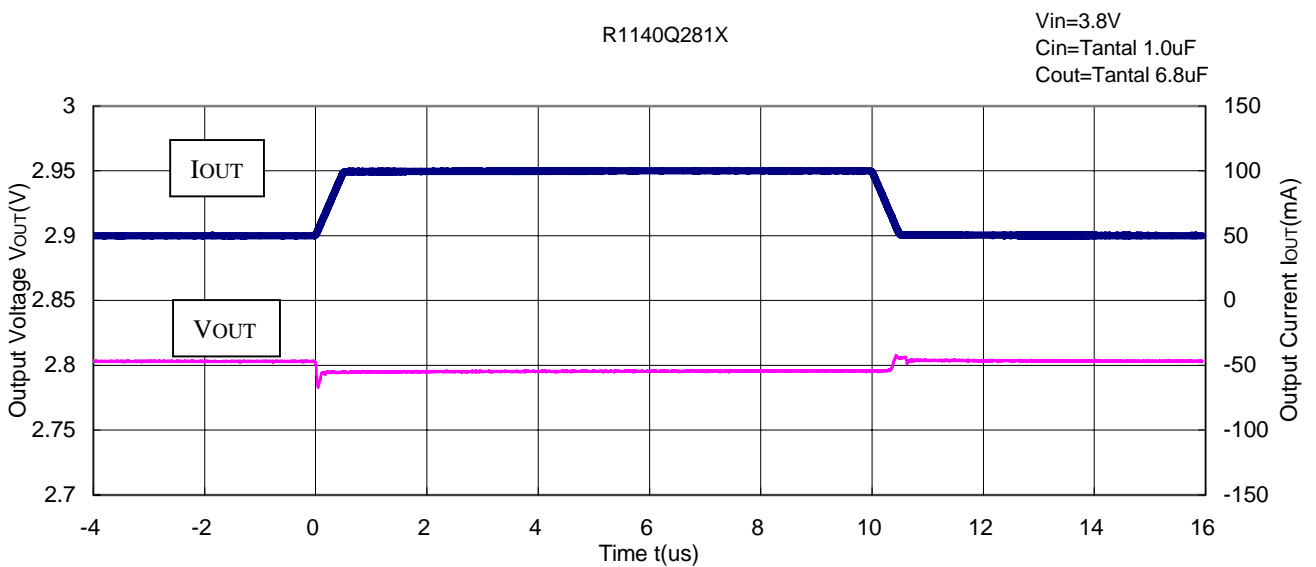
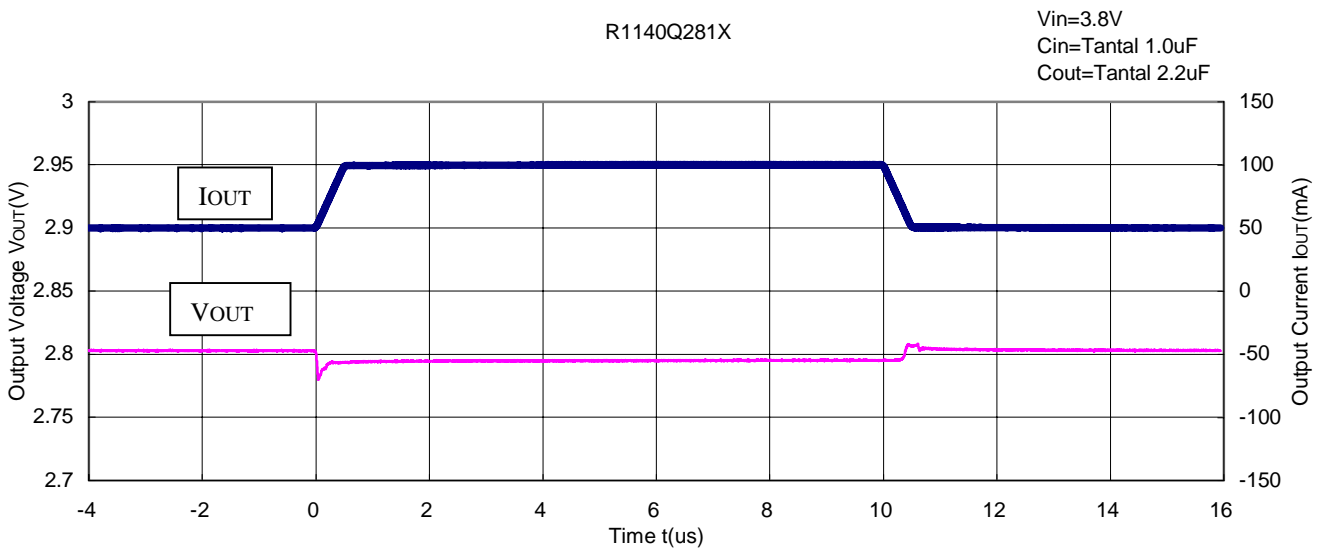
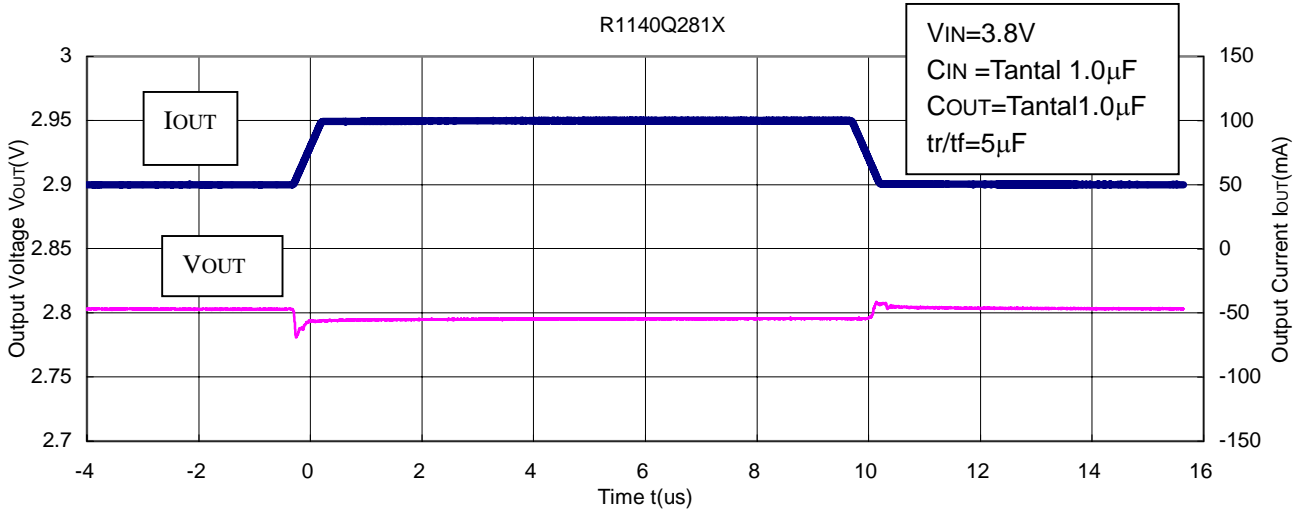

■ TECHNICAL NOTES

When using these ICs, consider the following points:

In these ICs, phase compensation is made for securing stable operation even if the load current is varied. For this purpose, be sure to use a capacitor C_{OUT} with good frequency characteristics and ESR (Equivalent Series Resistance) of which is in the range described as follows:

The relations between I_{OUT} (Output Current) and ESR of Output Capacitor are shown below. The conditions when the white noise level is under $40\mu\text{V(Avg.)}$ are marked as the hatched area in the graph.

<Test conditions>

- (1) $V_{IN}=3.8\text{V}$
- (2) Frequency band: 10Hz to 2MHz
- (3) Temperature: 25°C

