

NPN Silicon Planar Transistors

**BSX 45
BSX 46
BSX 47**

SIEMENS AKTIENGESELLSCHAFT D

BSX 45, BSX 46, and BSX 47 are epitaxial NPN silicon planar transistors in TO 39 case (5 C 3 DIN 41873). Their collectors are electrically connected to their cases. The transistors are particularly suitable for AF amplifiers and AF switching applications up to 1 A.

Type	Ordering code
BSX 45 ¹⁾	Q60218-X45
BSX 45-6	Q60218-X45-V6
BSX 45-10	Q60218-X45-V10
BSX 45-16	Q60218-X45-V16
BSX 46 ¹⁾	Q60218-X46
BSX 46-6	Q60218-X46-V6
BSX 46-10	Q60218-X46-V10
BSX 46-16	Q60218-X46-V16
BSX 47 ¹⁾	Q60218-X47
BSX 47-6	Q60218-X47-V6
BSX 47-10	Q60218-X47-V10

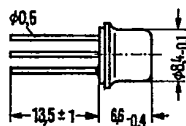

Approx. weight 1.5 g



Dimensions in mm

Maximum ratings

		BSX 45	BSX 46	BSX 47	
Collector-emitter voltage	V_{CEO}	40	60	80	V
Collector-emitter voltage	V_{CES}	80	100	120	V
Emitter-base voltage	V_{EBO}	7	7	7	V
Collector current	I_C	1	1	1	A
Base current	I_B	0.2	0.2	0.2	A
Junction temperature	T_j	200	200	200	°C
Storage temperature range	T_{stg}		-65 to +200		°C
Total power dissipation ($T_{case} \leq 25^\circ C$)	P_{tot}	5	5	5	W

Thermal resistance

Junction to ambient air	R_{thJA}	≤ 200	≤ 200	≤ 200	K/W
Junction to case	R_{thJC}	≤ 35	≤ 35	≤ 35	K/W

Static characteristics ($T_{amb} = 25^\circ C$)

Transistors BSX 45, BSX 46, and BSX 47 are grouped according to their DC current gain h_{FE} at $I_C = 100$ mA and $V_{CE} = 1$ V. The different groups are marked by figures of the DIN-R 5 standard series.

Type	BSX 45 BSX 46 BSX 47	BSX 45 BSX 46 BSX 47	BSX 45 BSX 46 -	BSX 45 BSX 46 BSX 47
h_{FE} group	6	10	16	
I_C mA	h_{FE} I_C/I_B	h_{FE} I_C/I_B	h_{FE} I_C/I_B	V_{BE} V
0.1	28 (> 10)	40 (> 15)	90 (> 25)	-
100	63 (40 to 100)	100 (63 to 160)	160 (100 to 250)	< 1
500	25 (> 15)	40 (> 25)	60 (> 35)	0.75 to 1.5
1000	15	20	30	1.3 (< 2)

1) In case of orders without an exact indication of the current amplification wanted, a transistor will be delivered of that current amplification group available at stock.

SIEMENS AKTIENGESELLSCHAFT

Static characteristics ($T_{amb} = 25^{\circ}\text{C}$)		BSX 45	BSX 46	BSX 47	
Collector-emitter saturation voltage ($I_C = 1\text{ A}$; $h_{FE} = 10$)	V_{CEsat}	0.7 (<1)	0.7 (<1)	-	V
Collector-emitter saturation voltage ($I_C = 0.5\text{ A}$; $h_{FE} = 20$)	V_{CEsat}	-	-	0.5 (<0.9)	V
Collector cutoff current ($V_{CES} = 60\text{ V}$)	I_{CES}	1 (<30)	1 (<30)	-	nA
Collector cutoff current ($V_{CES} = 60\text{ V}$; $T_{amb} = 150^{\circ}\text{C}$)	I_{CES}	1 (<10)	1 (<10)	-	μA
Collector cutoff current ($V_{CES} = 80\text{ V}$)	I_{CES}	-	-	<30	nA
Collector cutoff current ($V_{CES} = 80\text{ V}$; $T_{amb} = 150^{\circ}\text{C}$)	I_{CES}	-	-	<10	μA
Collector cutoff current ($V_{CE} = 60\text{ V}$; $V_{BE} = 0.2\text{ V}$; $T_{amb} = 100^{\circ}\text{C}$)	I_{CEX}	<50	<50	-	μA
Collector cutoff current ($V_{CE} = 80\text{ V}$; $V_{BE} = 0.2\text{ V}$; $T_{amb} = 100^{\circ}\text{C}$)	I_{CEX}	-	-	<50	μA
Emitter cutoff current ($V_{EBO} = 5\text{ V}$)	I_{EBO}	<10	<10	<10	nA
Collector-emitter breakdown voltage ($I_{CE} = 50\text{ mA}$; pulse length = 200 μs ; duty cycle 1%)	$V_{(BR)CEO}$	>40	>60	>80	V
Collector-emitter breakdown voltage ($I_{CES} = 100\text{ }\mu\text{A}$)	$V_{(BR)CES}$	>80	>100	>120	V
Emitter-base breakdown voltage ($I_{EBO} = 100\text{ }\mu\text{A}$)	$V_{(BR)EBO}$	>7	>7	>7	V

Dynamic characteristics ($T_{amb} = 25^{\circ}\text{C}$)

Transition frequency ($I_C = 50\text{ mA}$; $V_{CE} = 10\text{ V}$; $f = 20\text{ MHz}$)	f_T	>50	>50	>50	MHz
Collector-base capacitance ($V_{CBO} = 10\text{ V}$; $f = 1\text{ MHz}$)	C_{CBO}	<25	<20	<15	pF
Emitter-base capacitance ($V_{EBO} = 0.5\text{ V}$; $f = 1\text{ MHz}$)	C_{EBO}	<80	<80	<80	pF
Noise figure ($I_C = 100\text{ }\mu\text{A}$; $V_{CE} = 10\text{ V}$; $f = 1\text{ kHz}$; $\Delta f = 200\text{ Hz}$; $R_g = 1\text{ k}\Omega$)	NF	3.5	3.5	3.5	dB
Switching times $I_C = 100\text{ mA}$; I_{B1} approx. $-I_{B2}$ approx. 5 mA	t_{on} t_{off}	<200 <850	<200 <850	<200 <850	ns ns

- SIEMENS AKTIENGESELLSCHAFT

Test circuit for switching times

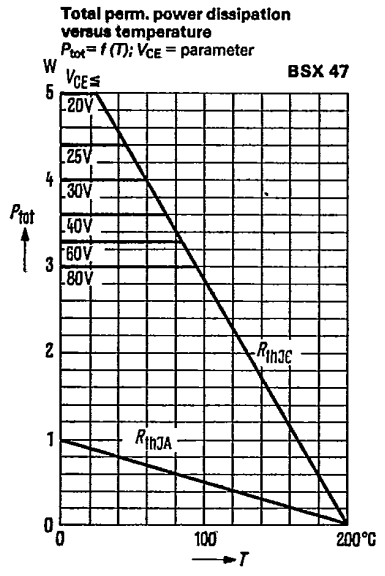
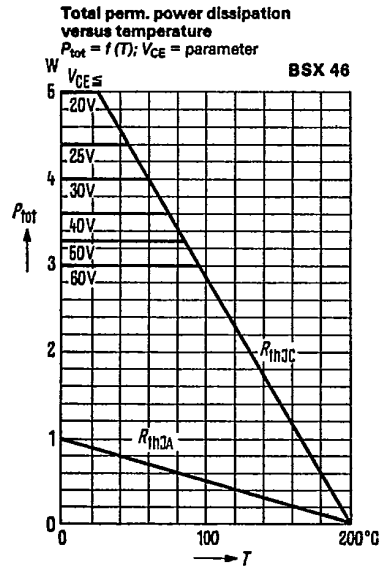
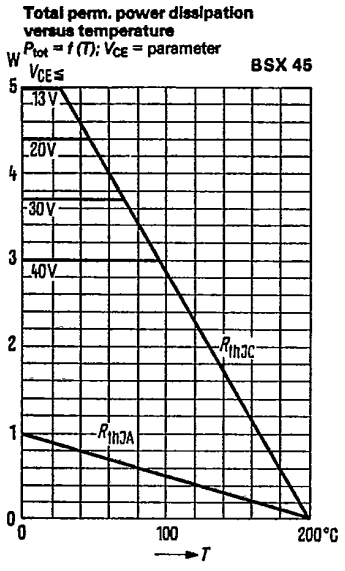
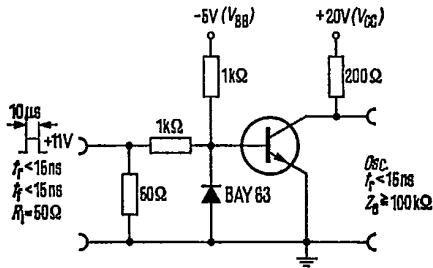

SIEMENS AKTIENGESELLSCHAFT

BSX 45
BSX 46
BSX 47

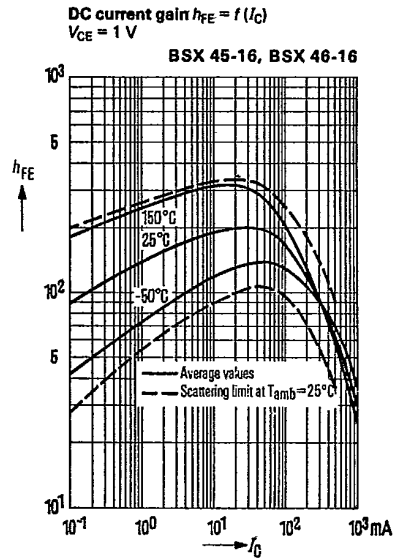
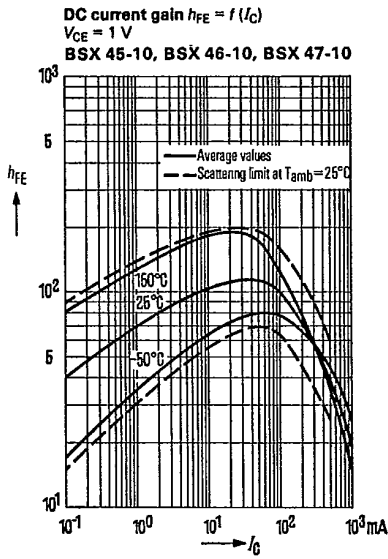
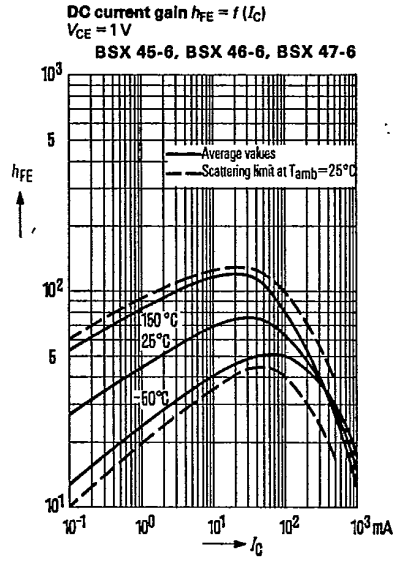
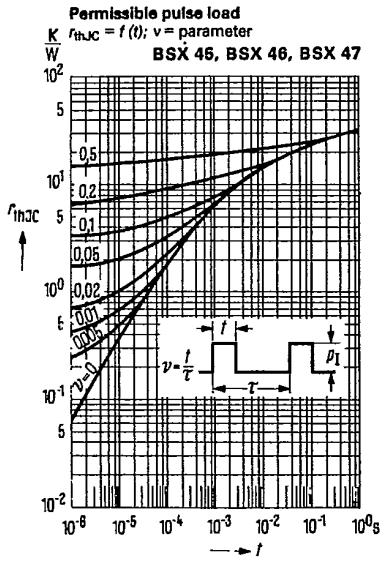

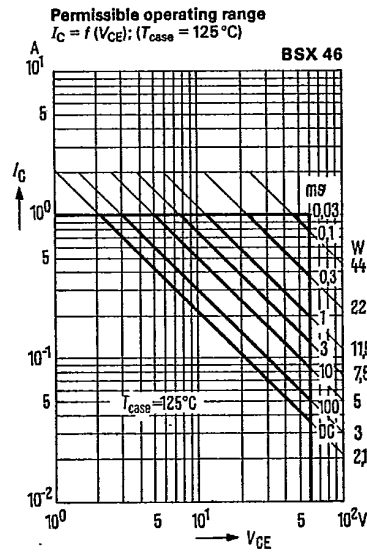
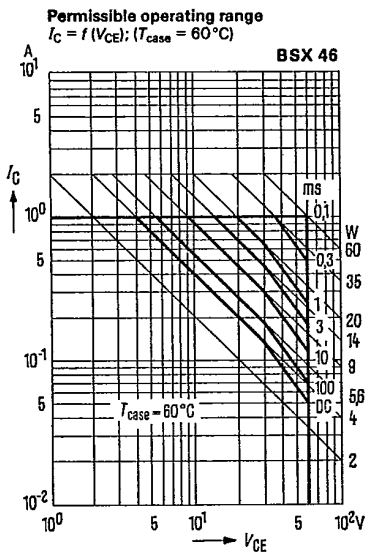
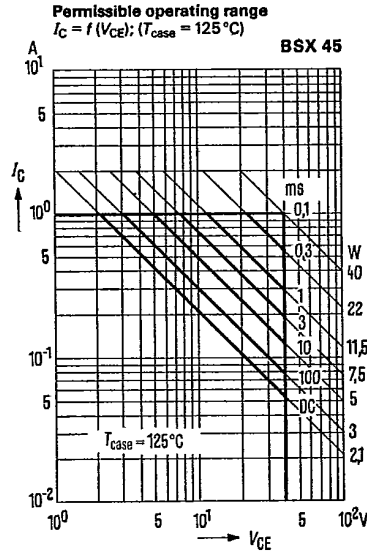
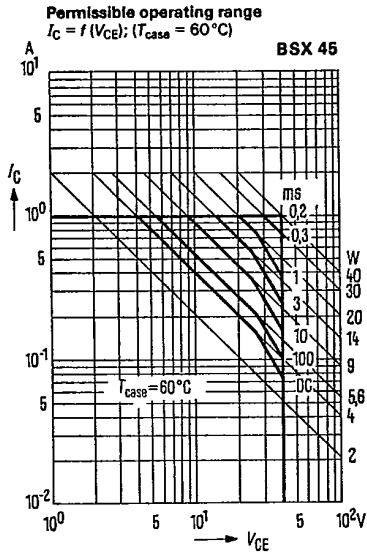

The permissible operating ranges apply to single pulses ($\nu = 0$). For pulse sequences the power dissipation has to be reduced in accordance with the diagram "permissible pulse load".

Permissible operating range
 $I_C = f(V_{CE})$; ($T_{case} = 80^\circ C$)

BSX 47

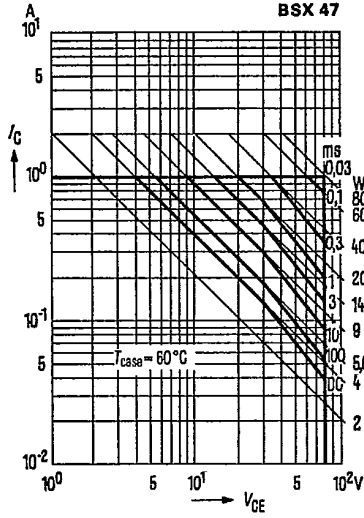

Permissible operating range
 $I_C = f(V_{CE})$; ($T_{case} = 125^\circ C$)

BSX 47

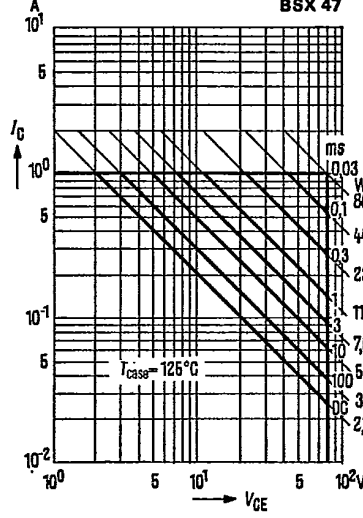

Collector current $I_C = f(V_{BE})$
 $V_{CE} = 1V$; $T_{amb} = \text{parameter}$
 (common emitter configuration)

BSX 45, BSX 46, BSX 47

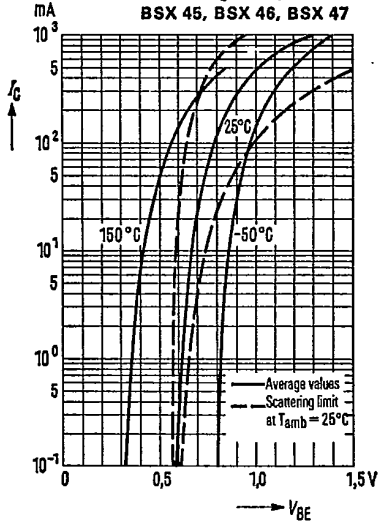

Output characteristics $I_C = f(V_{CE})$
 $I_B = \text{parameter}$
 (common emitter configuration)

BSX 45, BSX 46, BSX 47

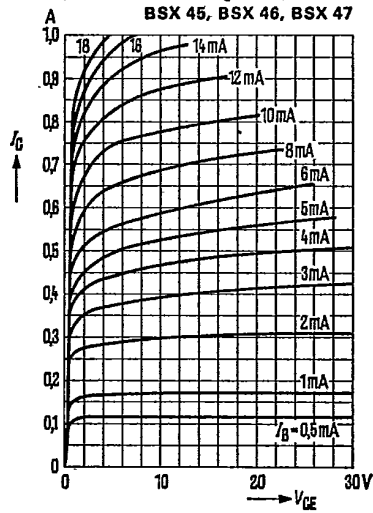

— SIEMENS AKTIENGESELLSCHAFT —

Output characteristics $I_C = f(V_{CE})$
 $I_B = \text{parameter}$
(common emitter configuration)

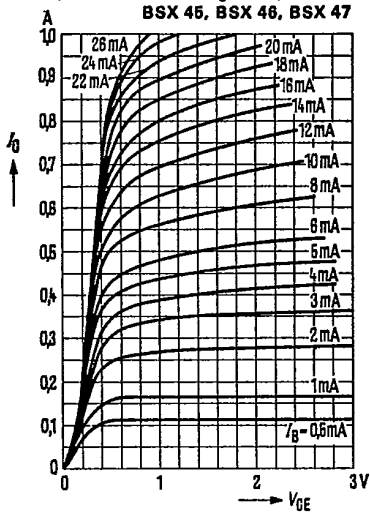

Output characteristics $I_C = f(V_{CE})$
 $I_B = \text{parameter}$
(common emitter configuration)

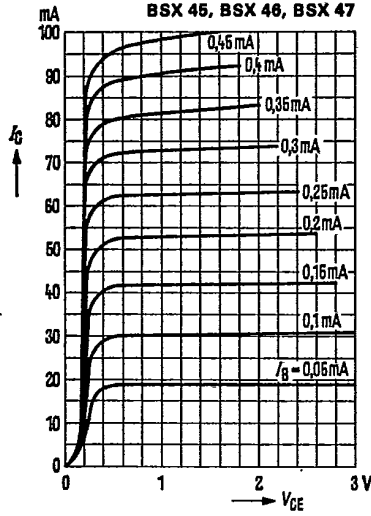

Saturation voltage $V_{CEsat} = f(I_C)$
 $h_{FE} = 10; T_{amb} = \text{parameter}$

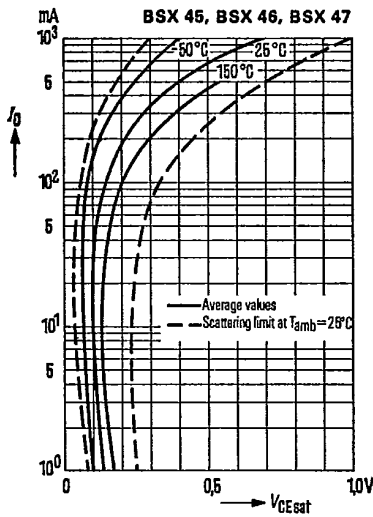

Saturation voltage $V_{BEsat} = f(I_C)$
 $h_{FE} = 10; V_{CE} = 1 \text{ V};$
 $T_{amb} = \text{parameter}$

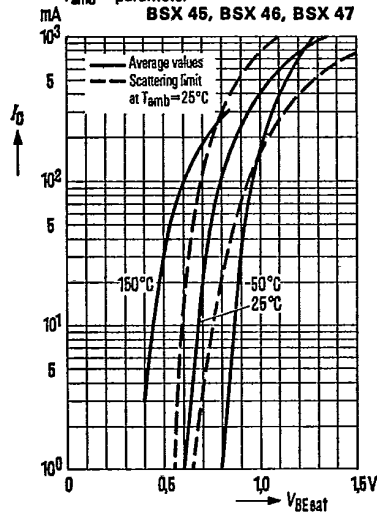

SIEMENS AKTIENGESELLSCHAFT

