

Typical Applications

- Narrow and Broadband Commercial and Military Radio Designs
- Linear and Saturated Amplifiers
- Gain Stage or Driver Amplifiers for MWRadio/Optical Designs (PTP/PMP/LMDS/UNII/VSAT/WLAN/Cellular/DWDM)

Product Description

The NLB-300 cascadable broadband InGaP/GaAs MMIC amplifier is a low-cost, high-performance solution for general purpose RF and microwave amplification needs. This 50Ω gain block is based on a reliable HBT proprietary MMIC design, providing unsurpassed performance for small-signal applications. Designed with an external bias resistor, the NLB-300 provides flexibility and stability. The NLB-300 is packaged in a low-cost, surface-mount plastic package, providing ease of assembly for high-volume tape-and-reel requirements.

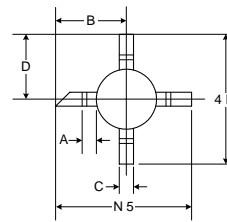

| DIM | MILLIMETERS | | | INCHES | | |
|-----|-------------|-------|-------|------------|-------|-------|
| | Min. | Nom. | Max. | Min. | Nom. | Max. |
| A | 0.535 REF. | | | 0.021 REF. | | |
| B | 2.39 | 2.54 | 2.69 | 0.094 | 0.100 | 0.106 |
| C | 0.436 | 0.510 | 0.586 | 0.017 | 0.020 | 0.023 |
| D | 2.19 | 2.34 | 2.49 | 0.086 | 0.092 | 0.098 |
| E | 1.91 | 2.16 | 2.41 | 0.075 | 0.085 | 0.095 |
| F | 1.32 | 1.52 | 1.72 | 0.052 | 0.060 | 0.068 |
| G | 0.10 | 0.15 | 0.20 | 0.004 | 0.006 | 0.008 |
| H | 0.535 | 0.660 | 0.785 | 0.021 | 0.026 | 0.031 |
| 1 J | 0.05 | 0.10 | 0.15 | 0.002 | 0.004 | 0.006 |
| 2 K | 0.65 | 0.75 | 0.85 | 0.025 | 0.029 | 0.033 |
| 3 L | 0.85 | 0.95 | 1.05 | 0.033 | 0.037 | 0.041 |
| 4 M | 4.53 | 4.68 | 4.83 | 0.178 | 0.184 | 0.190 |
| 5 N | 4.73 | 4.88 | 5.03 | 0.186 | 0.192 | 0.198 |

NOTE: All dimensions are in millimeters, and the dimensions in inches are for reference only.

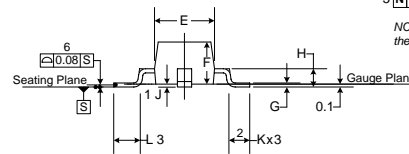

Optimum Technology Matching® Applied

- | | | |
|---|-----------------------------------|---------------------------------------|
| <input type="checkbox"/> Si BJT | <input type="checkbox"/> GaAs HBT | <input type="checkbox"/> GaAs MESFET |
| <input type="checkbox"/> Si Bi-CMOS | <input type="checkbox"/> SiGe HBT | <input type="checkbox"/> Si CMOS |
| <input checked="" type="checkbox"/> InGaP/HBT | <input type="checkbox"/> GaN HEMT | <input type="checkbox"/> SiGe Bi-CMOS |

Package Style: Micro-X, 4-Pin, Plastic

Features

- Reliable, Low-Cost HBT Design
- 13.0dB Gain, +11.1dBm P1dB @ 2GHz
- High P1dB of +14.1dBm @ 6.0GHz and +12.7dBm @ 10.0GHz
- Single Power Supply Operation
- 50Ω I/O Matched for High Freq. Use

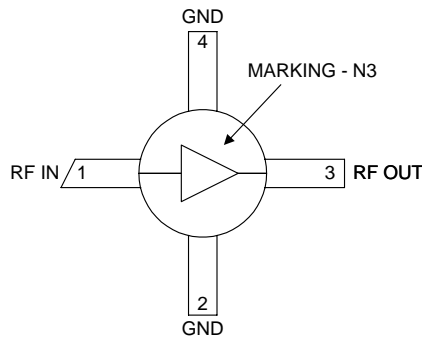

Functional Block Diagram

Ordering Information

NLB-300 Cascadable Broadband GaAs MMIC Amplifier DC to 10GHz
 NLB-300-T1 or -T3 Tape & Reel, 1000 or 3000 Pieces (respectively)
 NLB-300-E Fully Assembled Evaluation Board
 NBB-X-K1 Extended Frequency InGaP Amp Designer's Tool Kit
 RF Micro Devices, Inc. Tel (336) 664 1233
 7628 Thorndike Road Fax (336) 664 0454
 Greensboro, NC 27409, USA http://www.rfmd.com

NLB-300

Absolute Maximum Ratings

| Parameter | Rating | Unit |
|-----------------------|-------------|------|
| RF Input Power | +20 | dBm |
| Power Dissipation | 300 | mW |
| Device Current | 70 | mA |
| Channel Temperature | 200 | °C |
| Operating Temperature | -45 to +85 | °C |
| Storage Temperature | -65 to +150 | °C |

Exceeding any one or a combination of these limits may cause permanent damage.



Caution! ESD sensitive device.

RF Micro Devices believes the furnished information is correct and accurate at the time of this printing. However, RF Micro Devices reserves the right to make changes to its products without notice. RF Micro Devices does not assume responsibility for the use of the described product(s).

| Parameter | Specification | | | Unit | Condition |
|---|---------------|------------|------|-------|---|
| | Min. | Typ. | Max. | | |
| Overall | | | | | $V_D=+3.8V, I_{CC}=50mA, Z_0=50\Omega, T_A=+25^\circ C$ |
| Small Signal Power Gain, S21 | 12.0 | 13.0 | | dB | f=0.1GHz to 1.0GHz |
| | | 10.7 | | dB | f=1.0GHz to 4.0GHz |
| | | 8.9 | | dB | f=4.0GHz to 6.0GHz |
| | 8.5 | 8.9 | | dB | f=6.0GHz to 10.0GHz |
| | | 8.5 | | dB | f=10.0GHz to 12.0GHz |
| Gain Flatness, GF | | ±0.1 | | dB | f=5.0GHz to 10.0GHz |
| Input VSWR | | 2.2:1 | | | f=0.1GHz to 4.0GHz |
| | | 2.8:1 | | | f=4.0GHz to 7.0GHz |
| | | 2.0:1 | | | f=7.0GHz to 12.0GHz |
| Output VSWR | | 2.2:1 | | | f=0.1GHz to 4.0GHz |
| | | 2.9:1 | | | f=4.0GHz to 7.0GHz |
| | | 2.4:1 | | | f=7.0GHz to 12.0GHz |
| Output Power @ -1dB Compression, P1dB | | 11.1 | | dBm | f=2.0GHz |
| | | 14.1 | | dBm | f=6.0GHz |
| | | 12.7 | | dBm | f=10.0GHz |
| Noise Figure, NF | | 4.9 | | dB | f=3.0GHz |
| Third Order Intercept, IP3 | | +28.6 | | dBm | f=2.0GHz |
| | | +27.0 | | | f=6.0GHz |
| Reverse Isolation, S12 | | -16 | | dB | f=0.1GHz to 20.0GHz |
| Device Voltage, V_D | 3.6 | 3.8 | 4.2 | V | |
| Gain Temperature Coefficient, $\delta G_T / \delta T$ | | -0.0015 | | dB/°C | |
| MTTF versus Temperature @ $I_{CC}=50mA$ | | | | | |
| Case Temperature | | 85 | | °C | |
| Junction Temperature | | 113 | | °C | |
| MTTF | | >1,000,000 | | hours | |
| Thermal Resistance | | | | | |
| θ_{JC} | | 147 | | °C/W | $\frac{J_T - T_{CASE}}{V_D \cdot I_{CC}} = \theta_{JC} (^\circ C / Watt)$ |

| Pin | Function | Description | Interface Schematic |
|-----|----------|---|---------------------|
| 1 | RF IN | RF input pin. This pin is NOT internally DC-blocked. A DC-blocking capacitor, suitable for the frequency of operation, should be used in most applications. DC coupling of the input is not allowed, because this will override the internal feedback loop and cause temperature instability. | |
| 2 | GND | Ground connection. For best performance, keep traces physically short and connect immediately to ground plane. | |
| 3 | RF OUT | <p>RF output and bias pin. Biasing is accomplished with an external series resistor and choke inductor to V_{CC}. The resistor is selected to set the DC current into this pin to a desired level. The resistor value is determined by the following equation:</p> $R = \frac{(V_{CC} - V_{DEVICE})}{I_{CC}}$ <p>Care should also be taken in the resistor selection to ensure that the current into the part never exceeds maximum datasheet operating current over the planned operating temperature. This means that a resistor between the supply and this pin is always required, even if a supply near 5.0V is available, to provide DC feedback to prevent thermal runaway. Because DC is present on this pin, a DC-blocking capacitor, suitable for the frequency of operation, should be used in most applications. The supply side of the bias network should also be well bypassed.</p> | |
| 4 | GND | Same as pin 2. | |

NLB-300

Typical Bias Configuration

Application notes related to biasing circuit, device footprint, and thermal considerations are available on request.

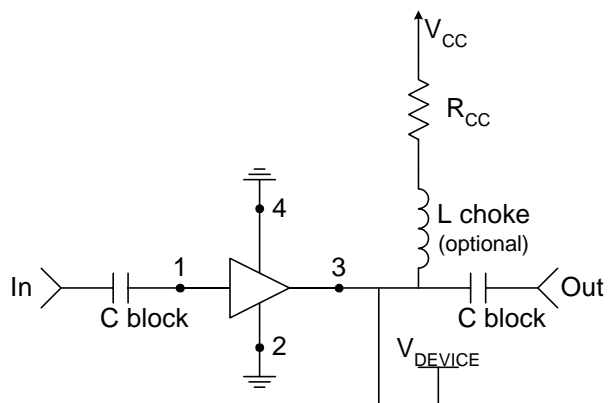

| Recommended Bias Resistor Values | | | | | | |
|--------------------------------------|----|----|-----|-----|-----|-----|
| Supply Voltage, V_{CC} (V) | 5 | 8 | 10 | 12 | 15 | 20 |
| Bias Resistor, R_{CC} (Ω) | 22 | 82 | 122 | 162 | 222 | 322 |

Extended Frequency InGaP Amplifier Designer's Tool Kit NBB-X-K1

This tool kit was created to assist in the design-in of the RFMD NBB- and NLB-series InGaP HBT gain block amplifiers. Each tool kit contains the following.

- 5 each NBB-300, NBB-310 and NBB-400 Ceramic Micro-X Amplifiers
- 5 each NLB-300, NLB-310 and NLB-400 Plastic Micro-X Amplifiers
- 2 Broadband Evaluation Boards and High Frequency SMA Connectors
- Broadband Bias Instructions and Specification Summary Index for ease of operation



Tape and Reel Dimensions

All Dimensions in Millimeters

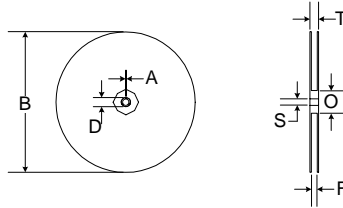

| 14.732 mm (7") REEL | | | Plastic, Micro-X | |
|---------------------|-----------------------|--------|------------------|---------------------|
| | ITEMS | SYMBOL | SIZE (mm) | SIZE (inches) |
| FLANGE | Diameter | B | 178 +0.25/-4.0 | 7.0 +0.079/-0.158 |
| | Thickness | T | 18.4 MAX | 0.724 MAX |
| | Space Between Flange | F | 12.8 +2.0 | 0.50 +0.08 |
| HUB | Outer Diameter | O | 76.2 REF | 3.0 REF |
| | Spindle Hole Diameter | S | 13.716 +0.5/-0.2 | 0.540 +0.020/-0.008 |
| | Key Slit Width | A | 1.5 MIN | 0.059 MIN |
| | Key Slit Diameter | D | 20.2 MIN | 0.795 MIN |

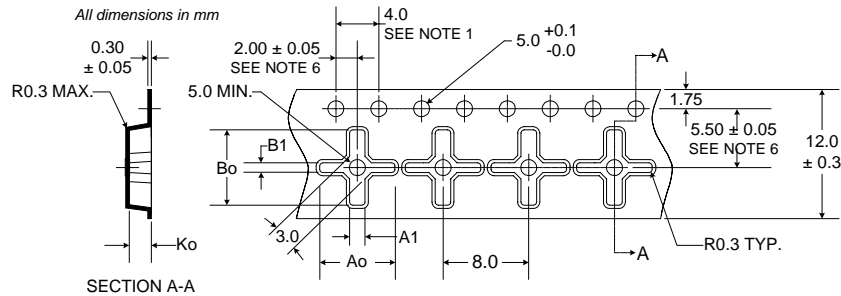
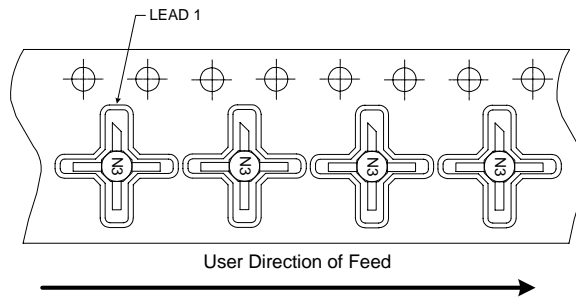

NOTES:

- 10 sprocket hole pitch cumulative tolerance ± 0.2 .
- Camber not to exceed 1 mm in 100 mm.
- Material: PS+C.
- Ao and Bo measured on a plane 0.3 mm above the bottom of the pocket.
- Ko measured from a plane on the inside bottom of the pocket to the surface of the carrier.
- Pocket position relative to sprocket hole measured as true position of pocket, not pocket hole.

Ao = 7.0 MM
 A1 = 1.8 MM
 Bo = 7.0 MM
 B1 = 1.3 MM
 Ko = 2.1 MM

S11 versus Frequency, Over Temperature

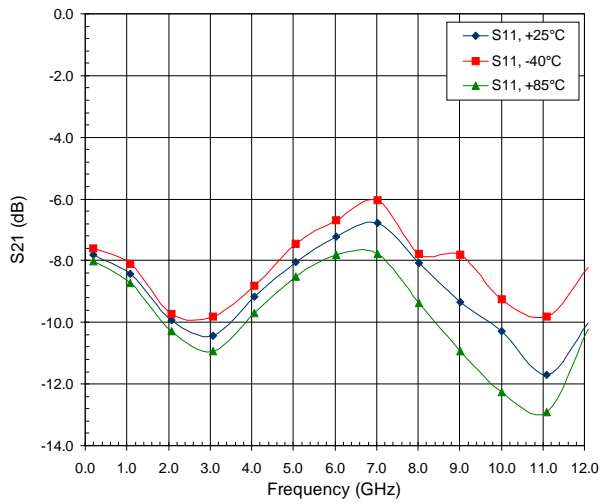

S21 versus Frequency, Over Temperature

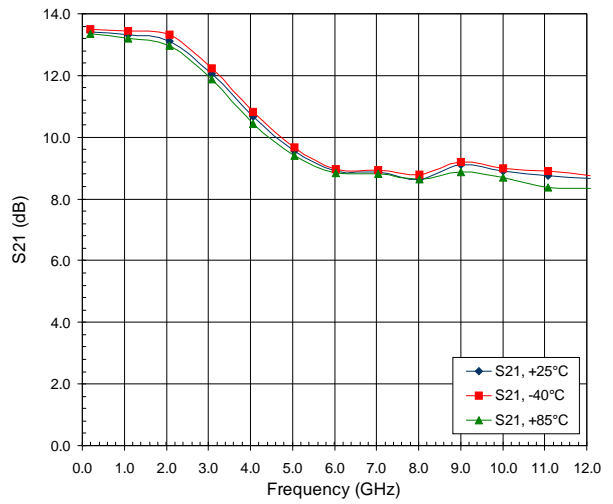

S12 versus Frequency, Over Temperature

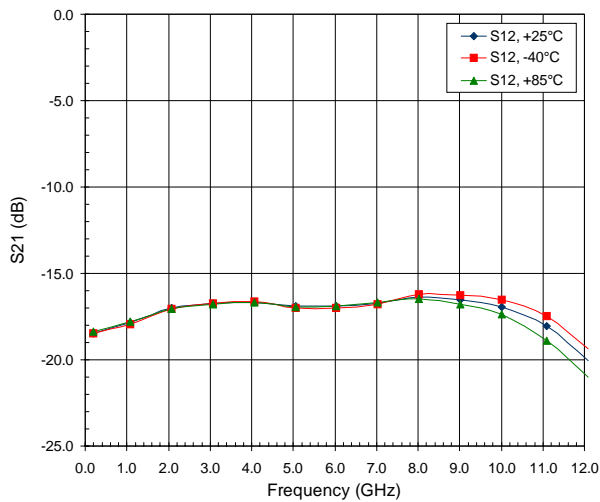

S22 versus Frequency, Over Temperature

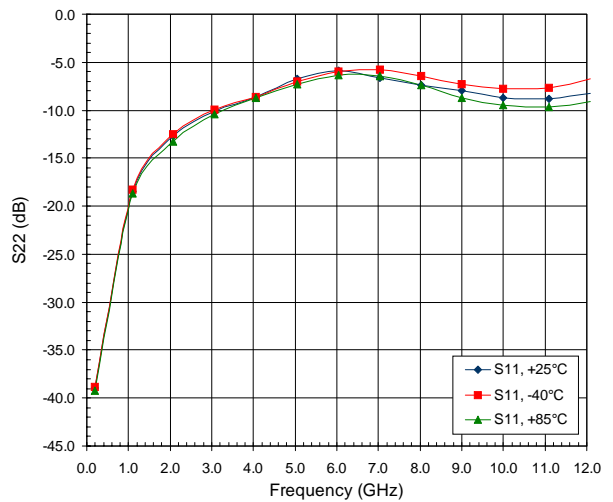

Output P1dB versus Frequency Across Temperature

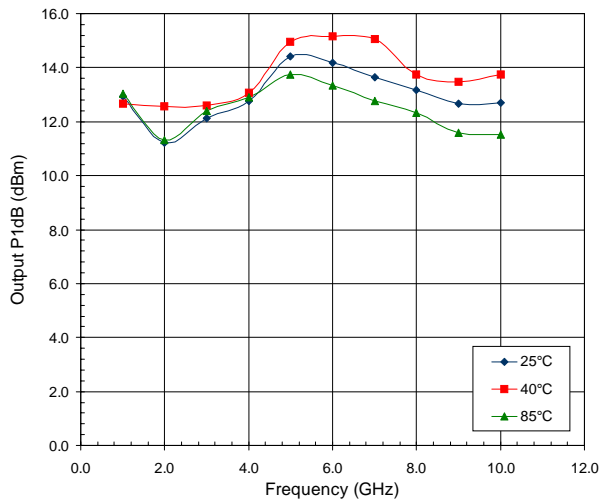

Noise Figure versus Frequency at +25°C

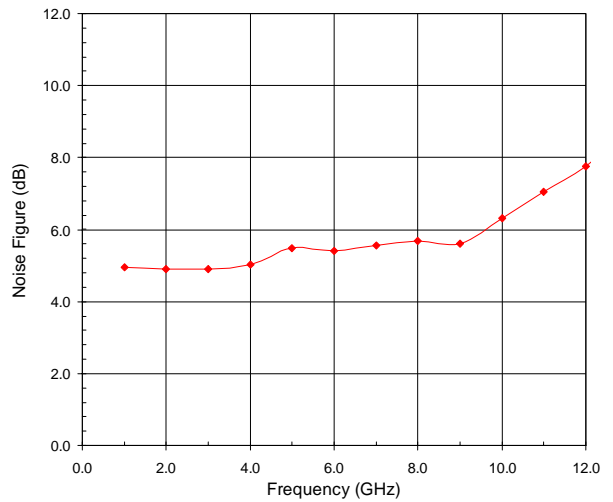

NLB-300

Note: The s-parameter gain results shown include device performance as well as evaluation board and connector loss variations. The insertion losses of the evaluation board and connectors are as follows:

1 GHz to 4 GHz=-0.06dB

5 GHz to 9GHz=-0.22dB

10GHz to 14GHz=-0.50dB

15GHz to 20GHz=-1.08dB