

FEATURES

- Soft Start
- Lead-Free Design
- Six-Sided Shielding
- Output Trim Function
- I/O Isolation 1500VDC
- MTBF > 600,000 hours
- 2:1 Input Voltage Range
- Very High Efficiency up to 88%
- Remote On/Off Control (Optional)
- Over Voltage and Short Circuit Protection
- EMI Complies with RN55022 Class A (Only for CG-A Series)



Dimensions: 2.0 x 1.0 x 0.4 inches

SPECIFICATIONS: CG Series

All specifications are based on 25°C, Nominal Input Voltage, and Maximum Output Current unless otherwise noted.
We reserve the right to change specifications based on technological advances.

SPECIFICATION	TEST CONDITIONS	Min	Nom	Max	Unit
INPUT (V_{in})					
Input Voltage Range (24V input models)		18	24	36	VDC
Input Voltage Range (48V input models)		36	48	75	VDC
Start Voltage 24V input models)		17	17.5	18	VDC
Start Voltage (48V input models)		34	35	36	VDC
Under Voltage Shutdown (24V input models)		16	16.5	17	VDC
Under Voltage Shutdown (48V input models)		32	33	34	VDC
Over Voltage Shutdown (24V input models)		40	42	44	VDC
Over Voltage Shutdown (48V input models)		80	82	84	VDC
Reverse Polarity Input Current	All models			2	A
Input Surge Voltage (1000ms) (24V input models)		-0.7		50	VDC
Input Surge Voltage (1000ms) (48V input models)		-0.7		100	VDC
Reflected Ripple Current		See Table			
Short Circuit Input Power	All models			4500	mW
Input Filter	All models	Pi Filter			
OUTPUT (V_o)					
Output Voltage Range		See Table			
Output Voltage Accuracy			±0.5	±1.0	%
Output Voltage Trim	% of nominal output voltage	±9.0	±10.0	±11.0	%
Load Regulation (2.5V, 3.3V, and 5Vout)	I _o = No Load to 100% Load		±0.5	±1.0	%
Load Regulation (12V and 15Vout)	I _o = 10% to 100% Load		±0.5	±1.0	%
Line Regulation	V _{in} = Min to Max		±0.1	±0.3	%
Output Power				30	W
Output Current Range		See Table			
Ripple & Noise (20MHz)			75	100	mV _{pk-pk}
Ripple & Noise (20MHz)	Over Line, Load, and Temperature			120	mV _{pk-pk}
Ripple & Noise (20MHz)				10	mVrms
Transient Recovery Time	25% Load Step Change	200		500	µs
Transient Response Deviation	25% Load Step Change		±2	±5	%
Maximum Capacitive Load		See Table			
Temperature Coefficient			±0.01	±0.02	%/°C
REMOTE ON/OFF CONTROL					
Supply On		2.5 to 100VDC or Open Circuit			
Supply Off		-1		1	VDC
Device Standby Input Current			2	5	mA
Control Input Current (On)				5	µA
Control Input Current (Off)				-100	µA
Control Common		Referenced to Negative Input			
PROTECTION					
Over Power Protection		110		160	%
Short Circuit Protection		Continuous			
Over Voltage Protection		See table			
Input Fuse Recommendation (24V input models)		3000mA Slow-Blow Type			
Input Fuse Recommendation (48V input models)		1500mA Slow-Blow Type			

SPECIFICATION	TEST CONDITIONS	Min	Nom	Max	Unit
GENERAL					
Efficiency		See Table			
Switching Frequency		280	350	400	KHz
Isolation Voltage Rated	60 seconds	1500			VDC
Isolation Voltage Test	Flash Tested for 1 second	1650			VDC
Isolation Resistance	500VDC	1000			MΩ
Isolation Capacitance	100KHz, 1V		1200	1500	pF
Internal Power Dissipation				5500	mW
ENVIRONMENTAL					
Operating Temperature (Ambient)		-40		+50	°C
Operating Temperature (Case)		-40		+105	°C
Storage Temperature		-55		+125	°C
Lead Temperature	1.5mm from case for 10 seconds			260	°C
Humidity				95	%
Cooling		Free air convection			
RFI		Six-sided shielded metal case			
MTBF	MIL-HDBK-217F @ 25°C, Ground Benign	600,000 Hours			
Conducted EMI		EN55022 Class A			
PHYSICAL					
Weight		32 grams			
Dimensions		50.8(L) x 25.4(W) x 10.2(H) mm			
Case Material		Aluminum anodizing treatment in black			

OUTPUT VOLTAGE / CURRENT RATING CHART

Model Number	Input Voltage	Output Voltage	Output Current		Input Current		Reflected Ripple Current	Over Voltage Protection	Max Capacitive Load	Efficiency (Typ)
			Min	Max	No Load	Max Load				
CG24S2.5-6000	24 VDC (18 – 36 VDC)	2.5 VDC	0mA	6000mA	50mA	744mA	100mA (typ)	3 VDC	6800μF	84%
CG24S3.3-6000		3.3 VDC	0mA	6000mA	50mA	959mA		3.9 VDC	6800μF	86%
CG24S5-5000		5 VDC	0mA	5000mA	70mA	1185mA		6.8 VDC	6800μF	88%
CG24S5.1-5000		5.1 VDC	0mA	5000mA	70mA	1207mA		6.8 VDC	6800μF	88%
CG24S12-2500		12 VDC	166mA	2500mA	20mA	1420mA		15 VDC	680μF	88%
CG24S15-2000		15 VDC	133mA	2000mA	20mA	1420mA		18 VDC	680μF	88%
CG48S2.5-6000	48 VDC (36 – 75 VDC)	2.5 VDC	0mA	6000mA	40mA	372mA	50mA (typ)	3 VDC	6800μF	84%
CG48S3.3-6000		3.3 VDC	0mA	6000mA	40mA	480mA		3.9 VDC	6800μF	86%
CG48S5-5000		5 VDC	0mA	5000mA	50mA	604mA		6.8 VDC	6800μF	88%
CG48S5.1-5000		5.1 VDC	0mA	5000mA	50mA	604mA		6.8 VDC	6800μF	88%
CG48S12-2500		12 VDC	166mA	2500mA	10mA	710mA		15 VDC	680μF	88%
CG48S15-2000		15 VDC	133mA	2000mA	10mA	710mA		18 VDC	680μF	88%

NOTES

- Specifications typical at +25°C, resistive load, nominal input voltage, rated output current unless otherwise noted.
- Transient Recovery Time is measured to within 1% error band for a step change in output load of 75% to 100%.
- Ripple & Noise measurement bandwidth is 0- 20MHz.
- These power converters require a minimum output loading to maintain specified regulation. Operation at no-load will not damage these devices, however they may not meet all listed specifications.
- All DC/DC converters should be externally fused at the front end for protection.
- Other input and output voltages may be available, please contact factory.
- Specifications subject to change without notice.
- To order the converter with Remote On/Off function, please add suffix "-RC" (Ex: CG48S5-5000(A)-RC).

BLOCK DIAGRAM

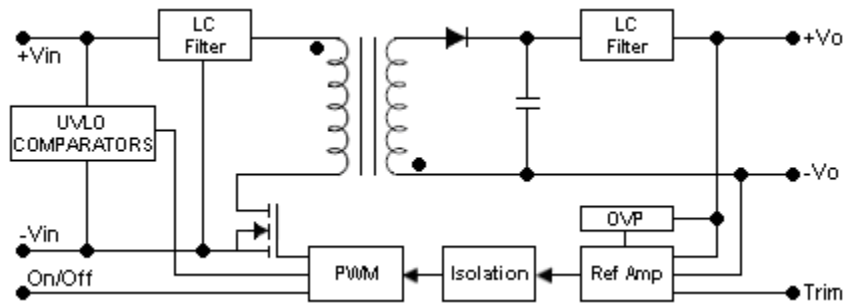

Input Voltage Transient Rating

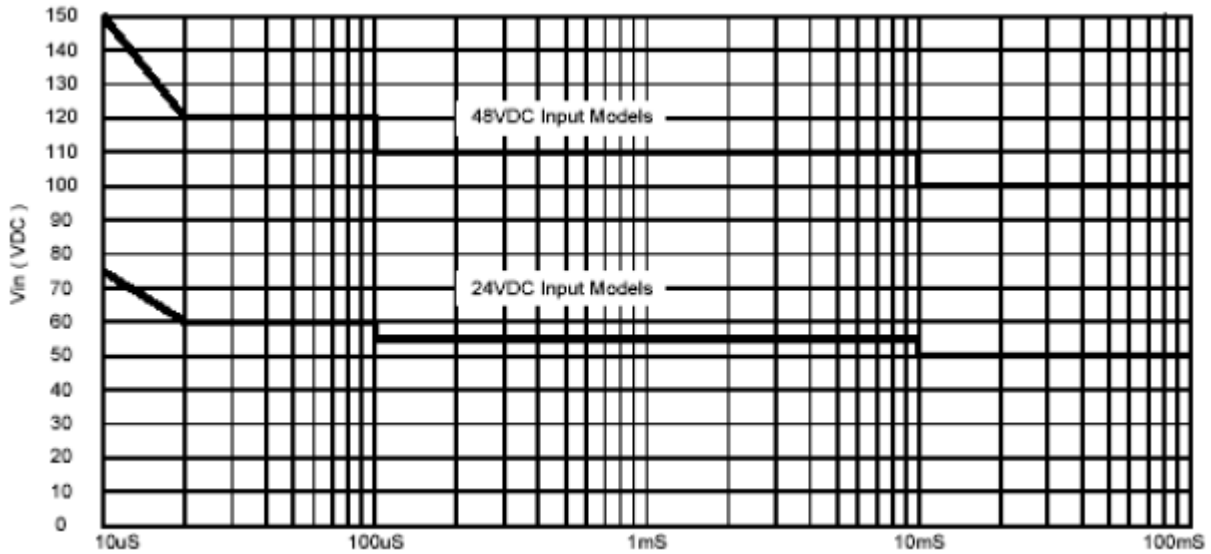

MECHANICAL DRAWING

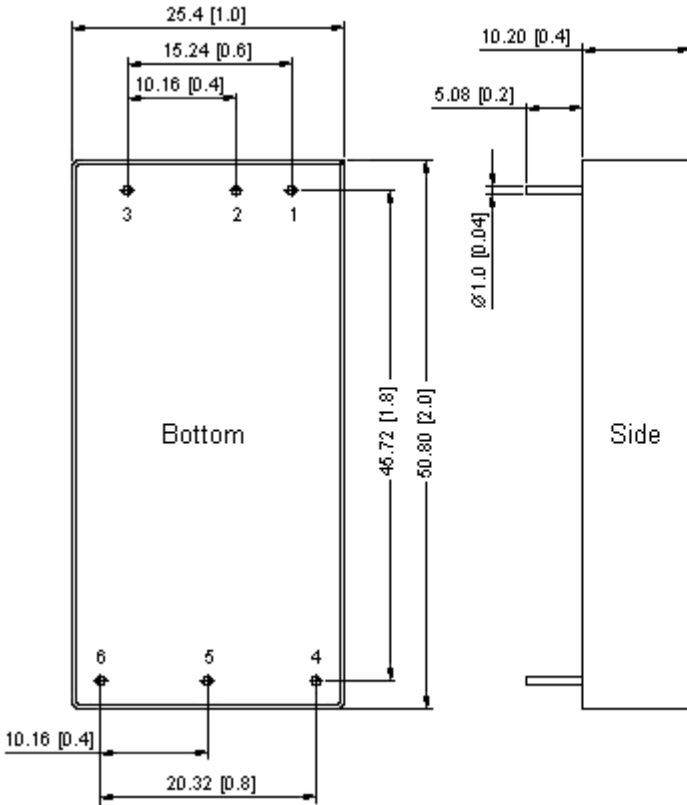

Connecting Pin Patterns

Top View (2.54 mm / 0.1 inch grids)

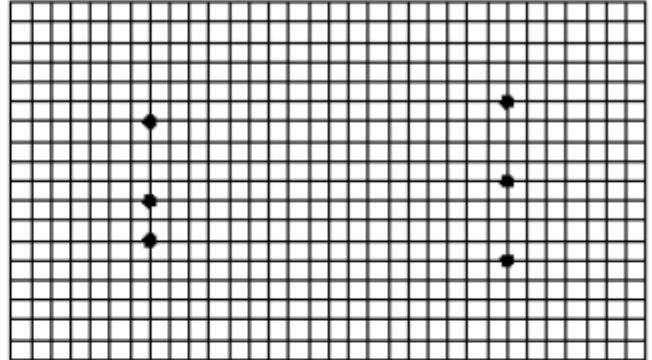

PIN CONNECTIONS	
Pin	Function
1	+Vin
2	-Vin
3	*Remote On/Off (option)
4	+Vout
5	-Vout
6	Trim

* See Note 8

- All dimensions in mm [inches]
 Tolerance: X.X±0.25 [X.XX±0.01]
 X.XX±0.13 [X.XXX±0.005]
- Pin: ±0.05 [±0.002]

DESIGN & FEATURE CONSIDERATIONS

Remote On/Off

Positive logic remote on/off turns the module on during a logic high voltage on the remote on/off pin and off during a logic low. Negative logic remote on/off turns the module off during a logic low and on during a logic high. To turn the power module on and off, the user must supply a switch to control the voltage between the on/off terminal and the -Vin terminal. The switch can be an open collector or equivalent.

A logic low is -0.7V to 1.0V.

A logic high is 2.5V to 100V.

The maximum sink current at the On/Off terminal (Pin 3) during a logic low is 100 mA. The maximum allowable leakage current of a switch connected to the On/Off terminal (Pin 3) at logic high (2.5V to 100V) is 5uA.

Output Voltage Trim

Output voltage trim allows the user to increase or decrease the output voltage set point of a module.

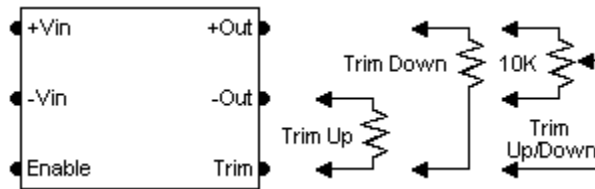

The output voltage can be adjusted by placing an external resistor (R_{adj}) between the Trim and +Vout or -Vout terminals. By adjusting R_{adj} , the output voltage can be changed by $\pm 10\%$ of the nominal output voltage.

A 10K, 1 or 10 Turn trimpot is usually specified for continuous trimming. Trim pin may be safely left floating if it is not used.

Connecting the external resistor ($R_{adj(up)}$) between the Trim and -Vout pins increases the output voltage set point as defined by the following equation:

$$R_{adj(up)} = \frac{(33 * V_{out}) - (30 * V_{adj})}{V_{adj} - V_{out}}$$

Connecting the external resistor ($R_{adj(down)}$) between the Trim and +Vout pins decreases the output voltage set point as defined by the following equation:

$$R_{adj(down)} = \frac{(36.667 * V_{adj}) - (33 * V_{out})}{V_{out} - V_{adj}}$$

Vout: Nominal Output Voltage
 Vadj: Adjusted Output Voltage
 Units: VDC/K Ω

Input Source Impedance

The power module should be connected to a low ac-impedance input source. Highly inductive source impedances can affect the stability of the power module.

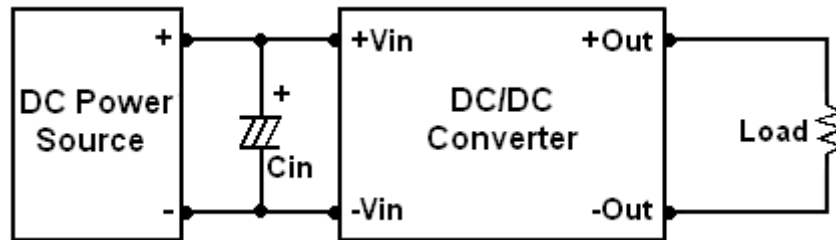

In applications where power is supplied over long lines and output loading is high, it may be necessary to use a capacitor at the input to ensure startup.

A capacitor mounted close to the power module helps ensure stability of the unit, it is recommended to use a good quality low Equivalent Series Resistance ($ESR < 1.0\Omega$ at 100 KHz) capacitor of 10uF for the 24V and 48V input devices.

Maximum Capacitive Load

The CG Series has a limitation of maximum connected capacitance at the output. The power module may be operated in current limiting mode during start-up, affecting the ramp-up and the startup time. The maximum capacitance can be found in the "Output Voltage / Current Rating Chart."

Over Current Protection

To provide protection in a fault (output overload) condition, the unit is equipped with internal current limiting circuitry and can endure current limiting for an unlimited duration. At the point of current-limit inception, the unit shifts from voltage control to current control. The unit operates normally once the output current is brought back into its specified range.

Output Over Voltage Protection

The output over voltage clamp consists of control circuitry, which is independent of the primary regulation loop that monitors the voltage on the output terminals. The control loop of the clamp has a higher voltage set point than the primary loop. This provides a redundant voltage control that reduces the risk of output over voltage. The OVP level can be found in the "Output Voltage / Current Rating Chart."

Thermal Considerations

Many conditions affect the thermal performance of the power module, such as orientation, airflow over the module, and board spacing. To avoid exceeding the maximum temperature rating of the components inside the power module, the case temperature must be kept below 105°C. The derating curves are determined from measurements obtained in an experimental apparatus.

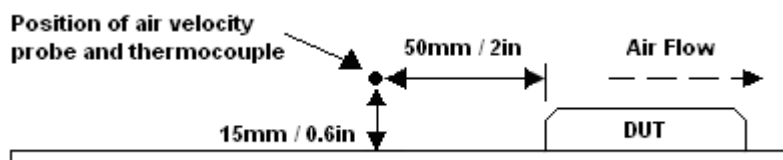

Efficiency vs Input Voltage

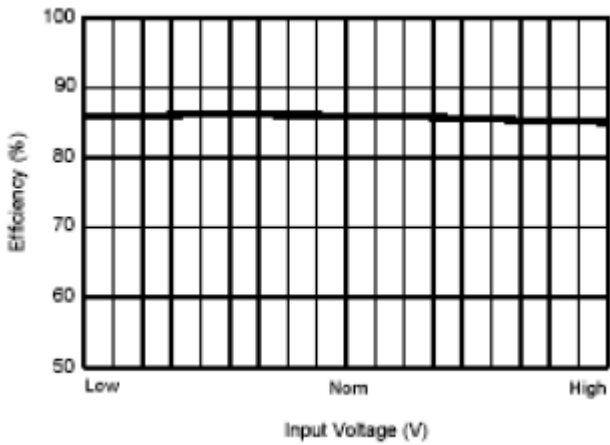

Efficiency vs Output Load

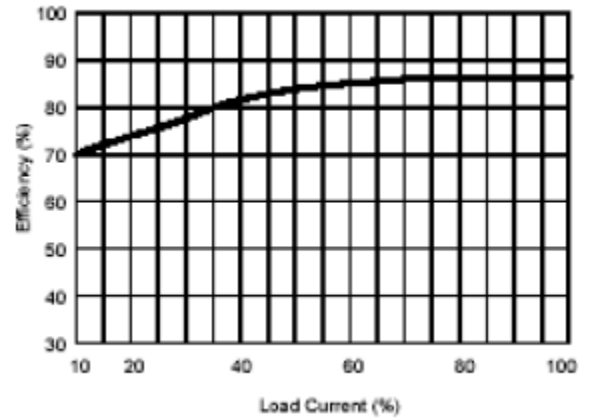

DERATING CURVE

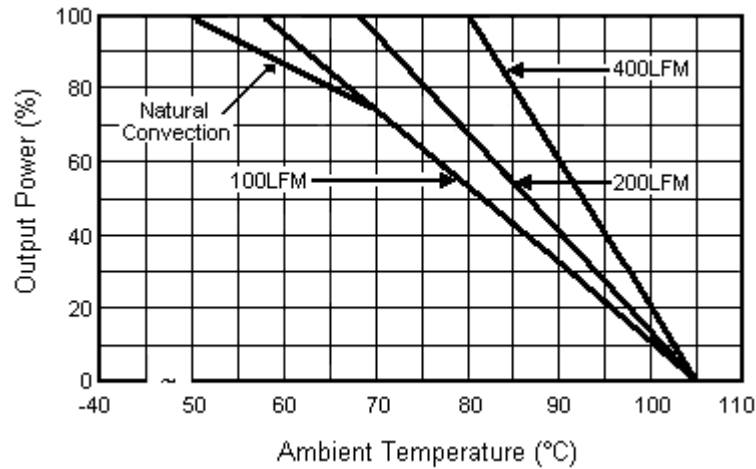

TEST CONFIGURATIONS

Input Reflected-Ripple Current Test Setup

Input reflected-ripple current is measured with an inductor L_{in} (4.7uH) and C_{in} (220uF, ESR < 1.0Ω at 100 KHz) to simulate source impedance.

Capacitor C_{in} offsets possible battery impedance.

Current ripple is measured at the input terminals of the module. Measurement bandwidth is 0-500 KHz.

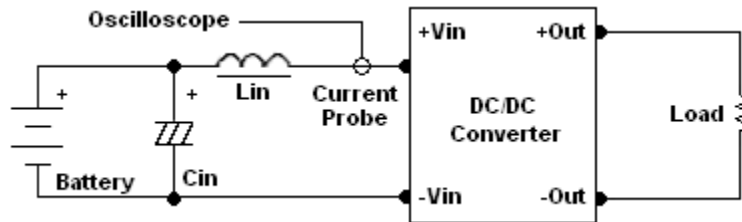

Peak-to-Peak Output Noise Measurement Test

Use C_{out} = 1.0uF ceramic capacitor.

Scope measurement should be made by using a BNC socket, measurement bandwidth is 0-20MHz. Position the load between 50mm and 75mm from the DC/DC Converter.

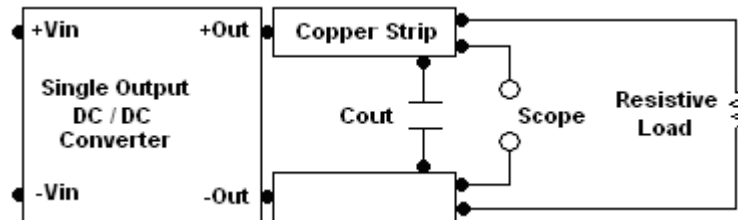

Output Ripple Reduction

A good quality low ESR capacitor placed as close as possible across the load will give the best ripple and noise performance. To reduce output ripple, it is recommended to use 4.7uF capacitors at the output.

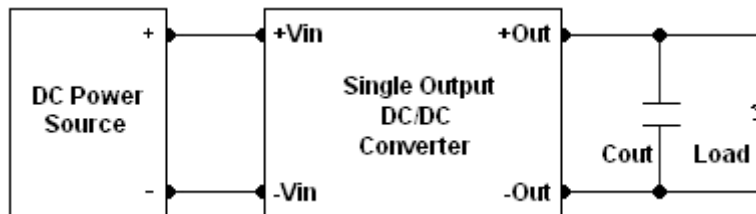



Wall Industries, Inc.

CG Series
Single Output
2:1 Input Voltage Range
30 Watt DC/DC Converter

COMPANY INFORMATION

Wall Industries, Inc. has created custom and modified units for over 40 years. Our in-house research and development engineers will provide a solution that exceeds your performance requirements on time and on budget. Our ISO9001-2000 certification is just one example of our commitment to producing a high quality, well documented product for our customers.

Our past projects demonstrate our commitment to you, our customer. Wall Industries, Inc. has a reputation for working closely with its customers to ensure each solution meets or exceeds form, fit and function requirements. We will continue to provide ongoing support for your project above and beyond the design and production phases. Give us a call today to discuss your future projects.

Contact **Wall Industries** for further information:

<u>Phone:</u>	☎ (603)778-2300
<u>Toll Free:</u>	☎ (888)587-9255
<u>Fax:</u>	☎ (603)778-9797
<u>E-mail:</u>	sales@wallindustries.com
<u>Web:</u>	www.wallindustries.com
<u>Address:</u>	5 Watson Brook Rd. Exeter, NH 03833