

Single Phase Full Wave Bridge Rectifiers — D.C. Current (I₀) to 25 Amperes

Hi-Pac® II Series

All bridges are available in FAST RECOVERY versions, T_{RR} <200ns. To order, add FS to suffix.

PART NO.	JEDEC PART NO.	PRV VOLTS	V _F VOLTS	I ₀ AMPS	I _R μA	I _{FSM} AMPS	T _{RR} nsec	CASE STYLE
BHC0001		100	1.2	10	10	300		3A
BHC0002		200	1.2	10	10	300		3A
BHC0003		300	1.2	10	10	300		3A
BHC0004		400	1.2	10	10	300		3A
BHC0005		600	1.2	10	10	300		3A
K850-0		50	1.2	10	10	300		3B
K850-1		100	1.2	10	10	300		3B
K850-2		200	1.2	10	10	300		3B
K850-3		300	1.2	10	10	300		3B
K850-4		400	1.2	10	10	300		3B
K850-6		600	1.2	10	10	300		3B
K850-8		800	1.2	10	10	300		3B
TJ118-0		50	1.2	10	10	300		3C
TJ118-1		100	1.2	10	10	300		3C
TJ118-2		200	1.2	10	10	300		3C
TJ118-3		300	1.2	10	10	300		3C
TJ118-4		400	1.2	10	10	300		3C
TJ118-5		500	1.2	10	10	300		3C
TJ118-6		600	1.2	10	10	300		3C
TJ118-8		800	1.2	10	10	300		3C
E814-0		50	1.0	12	25	300		3D
E814-1		100	1.0	12	25	300		3D
E814-2		200	1.0	12	25	300		3D
E814-3		300	1.0	12	25	300		3D
E814-4		400	1.0	12	25	300		3D
E814-6		600	1.0	12	25	300		3D
E814-8		800	1.0	12	25	300		3D
E815-0		50	1.0	15	25	300		3D
E815-1		100	1.0	15	25	300		3D
E815-2		200	1.0	15	25	300		3D
E815-3		300	1.0	15	25	300		3D
E815-4		400	1.0	15	25	300		3D
E815-6		600	1.0	15	25	300		3D
E815-8		800	1.0	15	25	300		3D
G775-0U		50	1.0	25	10	300		3E
G775-1U		100	1.0	25	10	300		3E
G775-2U		200	1.0	25	10	300		3E
G775-3U		300	1.0	25	10	300		3E
G775-4U		400	1.0	25	10	300		3E
G775-6U		600	1.0	25	10	300		3E
G775-8U		800	1.0	25	10	300		3E
J775-0		50	1.0	25	10	300		3F
J775-1		100	1.0	25	10	300		3F
J775-2		200	1.0	25	10	300		3F
J775-3		300	1.0	25	10	300		3F
J775-4		400	1.0	25	10	300		3F
J775-6		600	1.0	25	10	300		3F
J775-8		800	1.0	25	10	300		3F

For Case Outlines and Dimensions see Pages 36-41.

Case Outlines and Dimensions

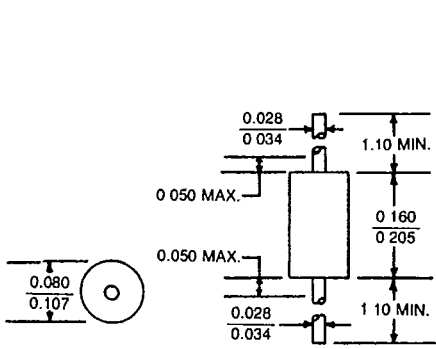

**Case Style 1A
(DO-41)**

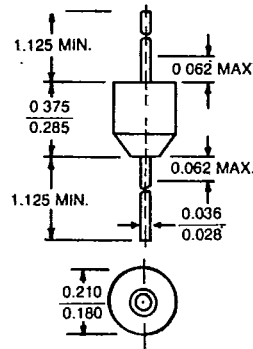

**Case Style 1B
(DO-27)**

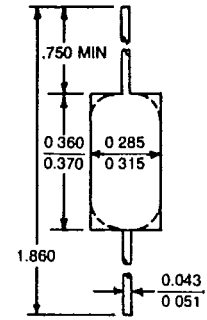

Case Style 1C

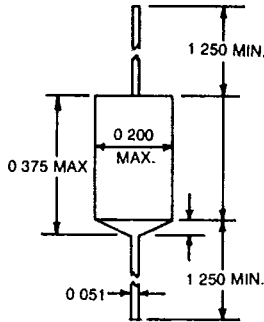

Case Style 1D

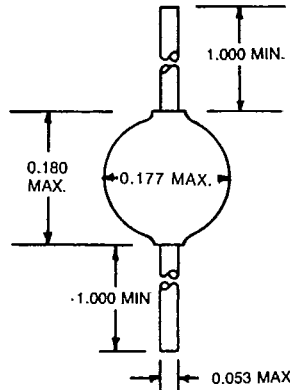

Case Style 1E

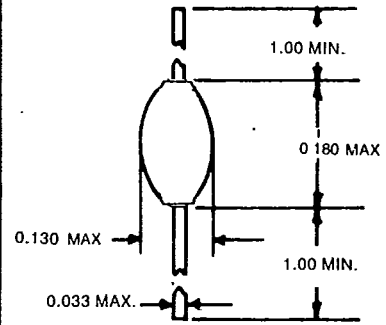

Case Style 1F

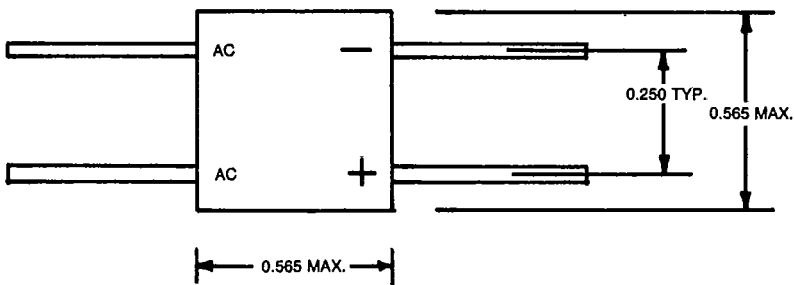

Case Style 2A*

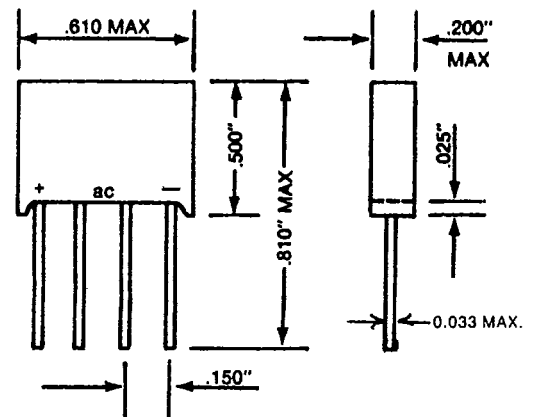
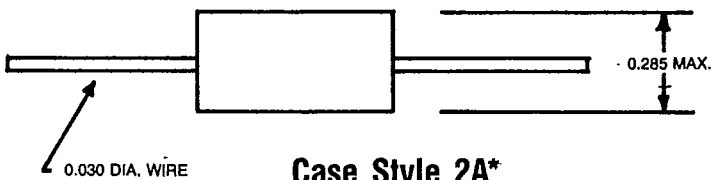

Case Style 2B*

*Also available in lower cost conformal coated package.

Case Outlines and Dimensions

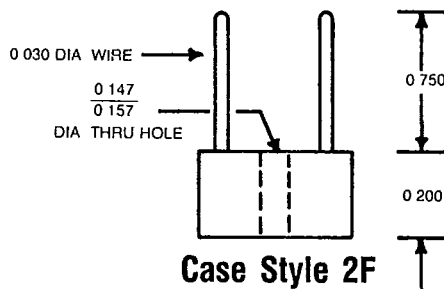
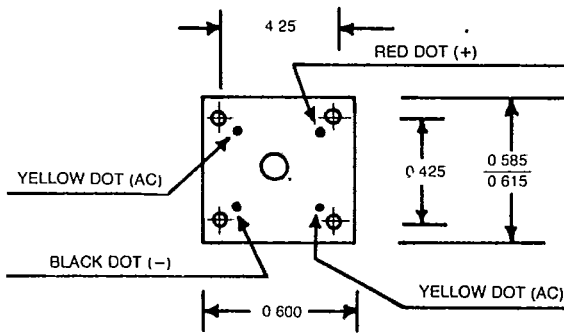
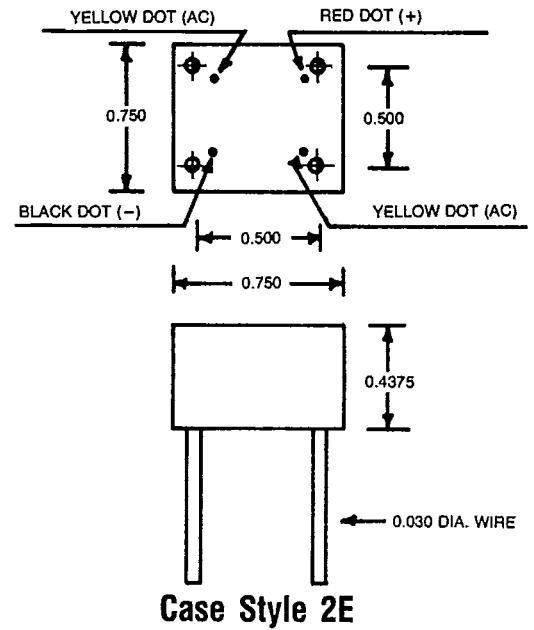
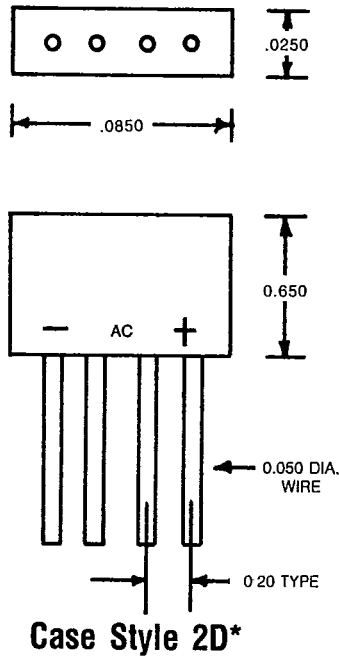
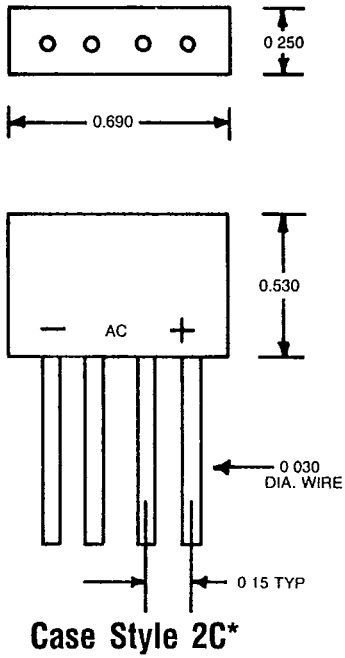

Case Style 2F

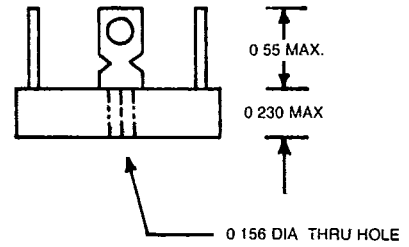
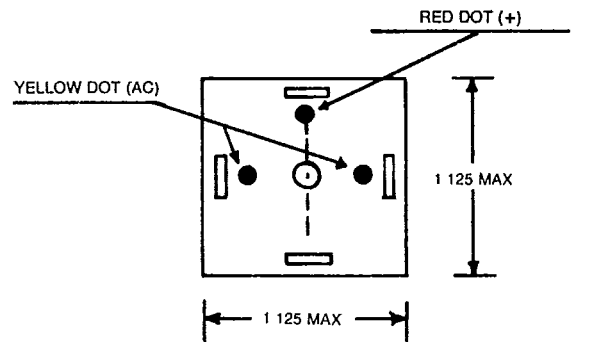

Case Style 2G

*Also available in lower cost conformal coated package.

Case Outlines and Dimensions

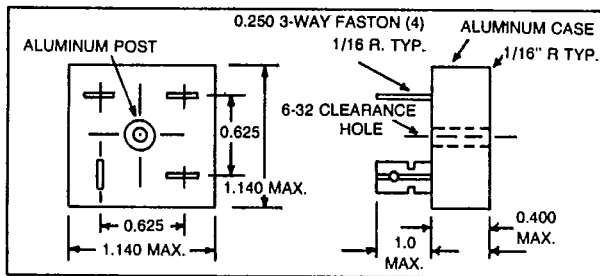
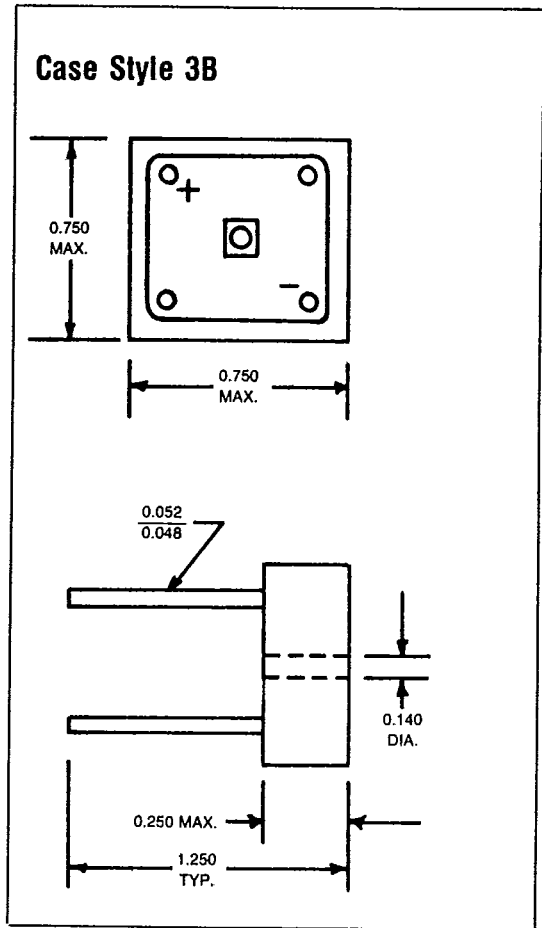
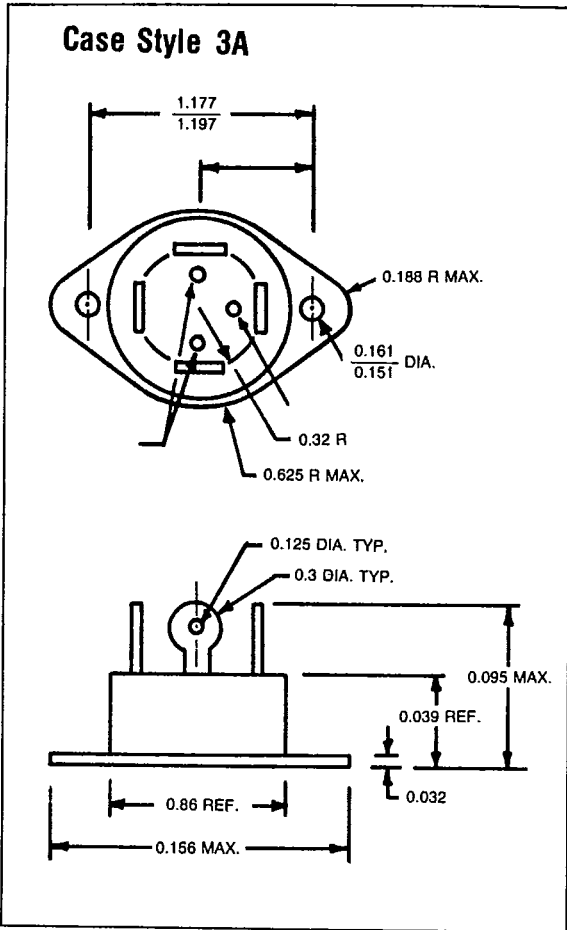

Case Style 3C

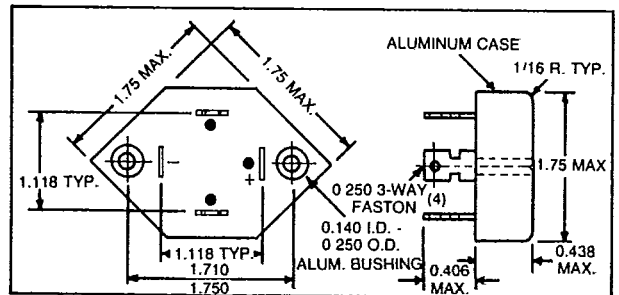

Case Style 3D

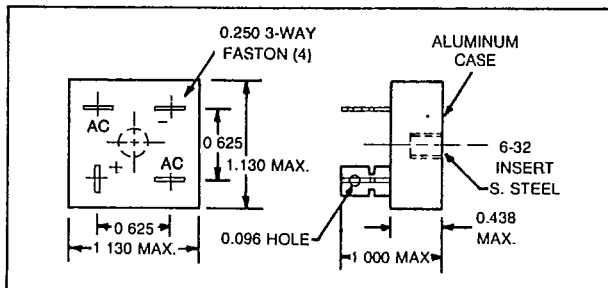

Case Style 3E

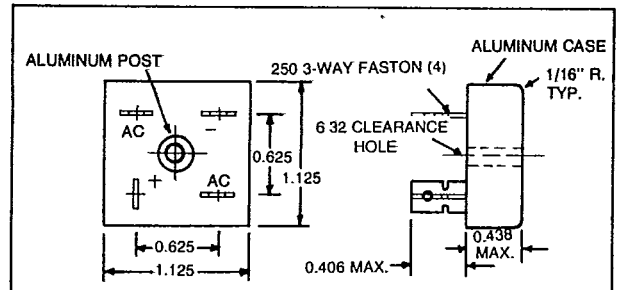

Case Style 3F

T-23-05

Case Outlines and Dimensions

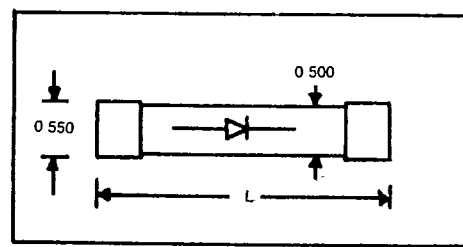
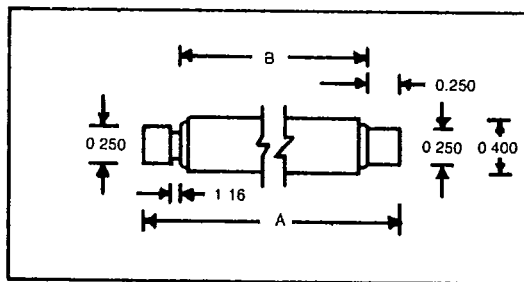
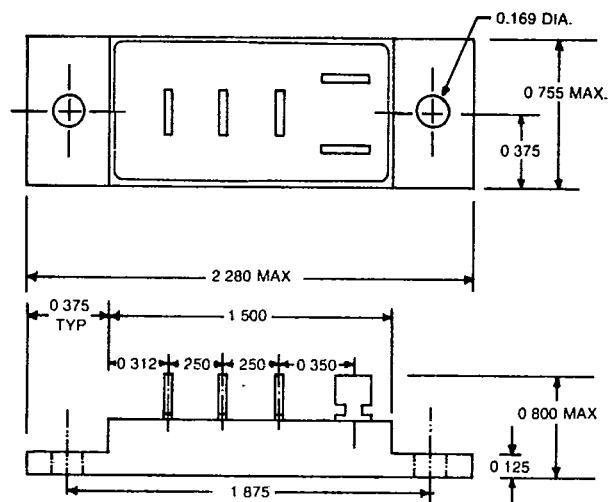
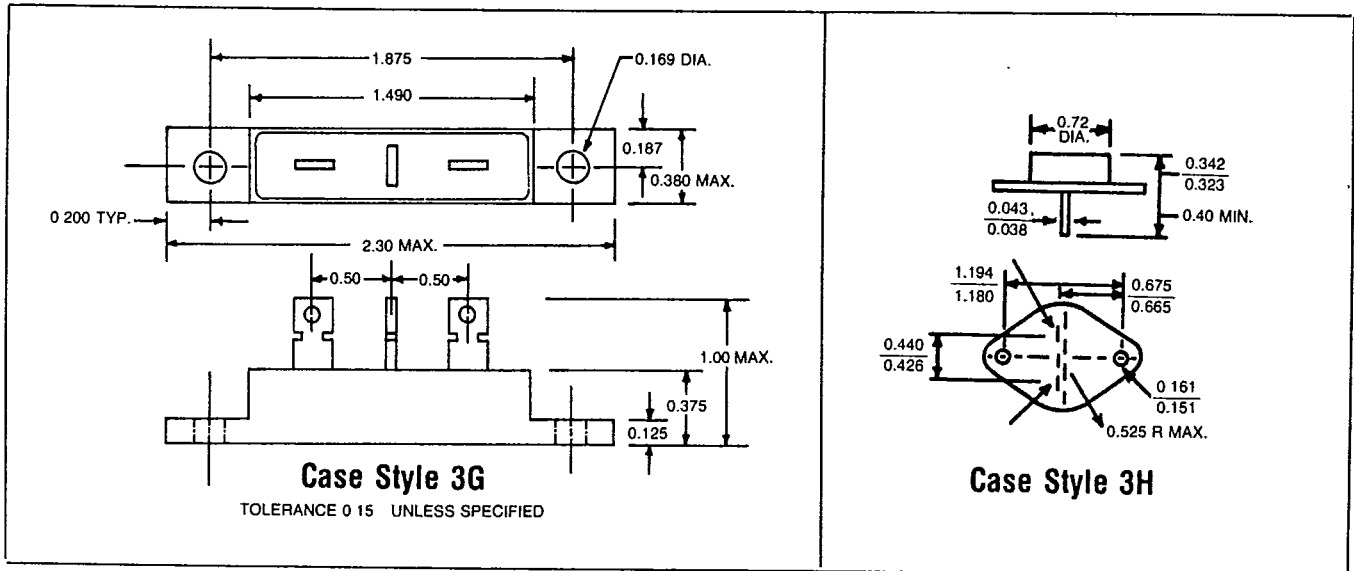

Case Outlines and Dimensions

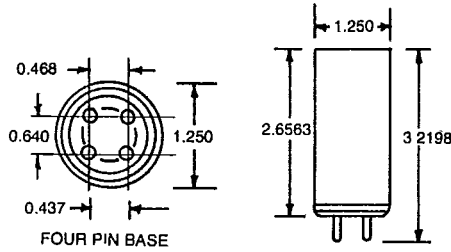

Case Style 6A

PART NO.	A	B	C
1N1150	3-7/32"	2-21/32"	1-1/4"
1N2634			

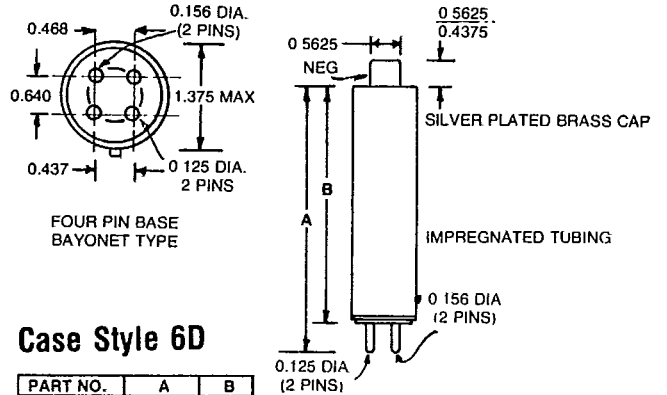

Case Style 6D

PART NO.	A	B
T7KV	4-1/16	3-1/2
T10KV	5-1/8	4-1/2
1N2637		

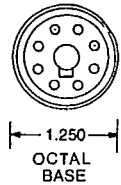

OCTAL BASE

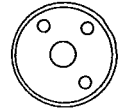

THREE PIN BASE

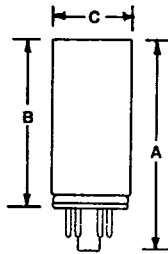

Case Style 6B

PART NO.	A	B	C	NO. OF PINS
1N1237				8
1N1238				8
1N2631	3-7/32	2-21/32	1-1/4	8
1N2632				
1N2633				
1N1239	4-5/16	3-3/4	1-3/8	3
1N1262	4-5/16	3-3/4	1-3/16	8
1N2389	3.25 1.125	2.6875 0.5625	1-3/16	8

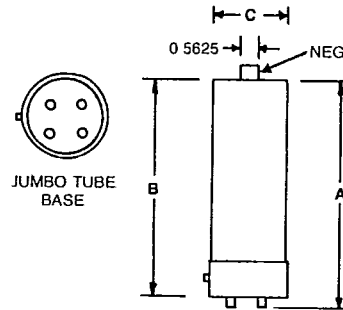

JUMBO TUBE BASE

Case Style 6E

PART NO.	A	B	C	(-) PIN CONN.
2ASLD-10TRA	7-3/4	7-3/8	2-5/16	4
2ASLD-15TR	9-3/4	9-3/8	3-7/8	4

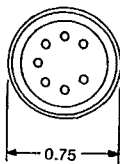

SEVEN PIN MINIATURE BASE

Case Style 6C

PART NO.	A	B
1N2490		
1N2630	1-3/4"	1-1/2"
1N2635		

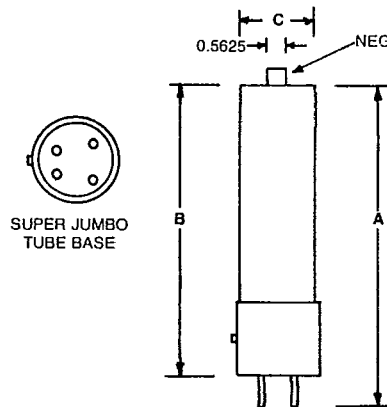
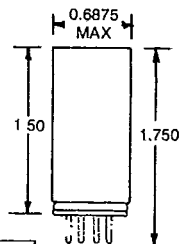

SUPER JUMBO TUBE BASE

Case Style 6F

PART NO.	A	B	C	(+) PIN CONN.
2ASLD-10TRB	8-1/4	7-1/2	2-5/16	3
2ASLD-40TR	9-1/8	8-3/8	2-5/16	2

Case Outlines and Dimensions

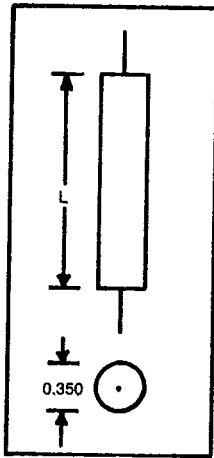

Case Style 5A*

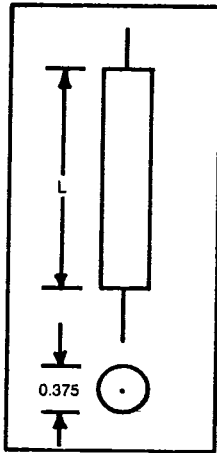

Case Style 5B*

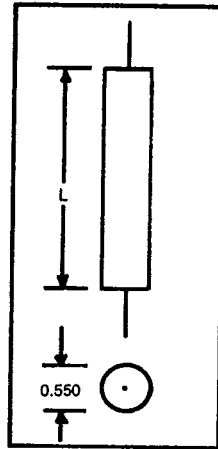

Case Style 5C*

*Lead Length 0.032" x 1.25" Long.

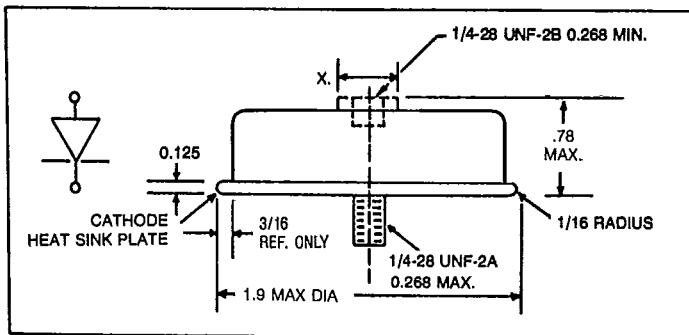

Case Style 7A

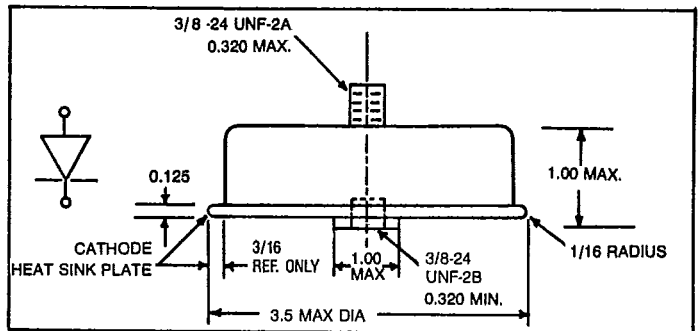

Case Style 7B

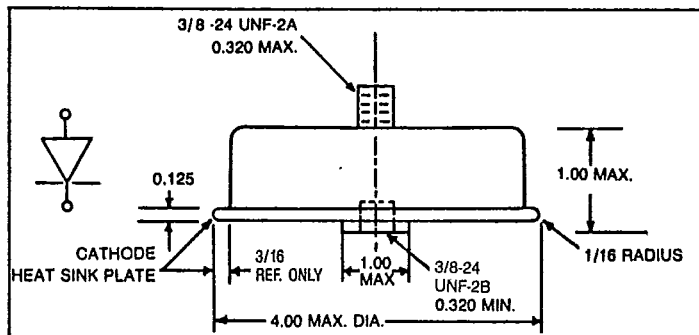

Case Style 7C