

S101DH1/S101DH2 S201DH1/S201DH2

16-Pin DIP Type SSR for Low Power Control

■ Features

1. Compact
(16-pin dual-in-line package type)
2. High output current
(RMS ON-state current I_T : 1.5A_{rms})
3. Built-in zero-cross circuit
(S101DH2 / S201DH2)
4. Recognised by UL, file No. E94758
5. Approved by CSA, No. LR63705

■ Applications

1. Air conditioners
2. Microwave ovens
3. Home appliances

■ Model Line-ups

	For 100V lines	For 200V lines
No built-in zero-cross circuit	S101DH1	S201DH1
Built-in zero-cross circuit	S101DH2	S201DH2

■ Absolute Maximum Ratings

(Ta = 25°C)

Parameter	Symbol	Rating		Unit
		S101DH1/ S101DH2	S201DH1/ S201DH2	
Input	Forward current	I_F	50	mA
	Reverse current	V_R	6	V
Output	RMS ON-state current	I_T	1.5	A _{rms}
	Peak one cycle surge current	I_{surge}	15 (50Hz, sine wave)	A
	Repetitive peak OFF-state voltage	V_{DRM}	400 600	V
*1 Isolation voltage		V_{iso}	4,000	V _{rms}
Operating temperature		T_{opr}	- 25 to + 85	°C
Storage temperature		T_{stg}	- 40 to + 125	°C
Soldering temperature		T_{sol}	260 (For 10 seconds)	°C

*1 AC for 1 minute, 40 to 60% RH, f = 60Hz

■ Outline Dimensions

(Unit : mm)

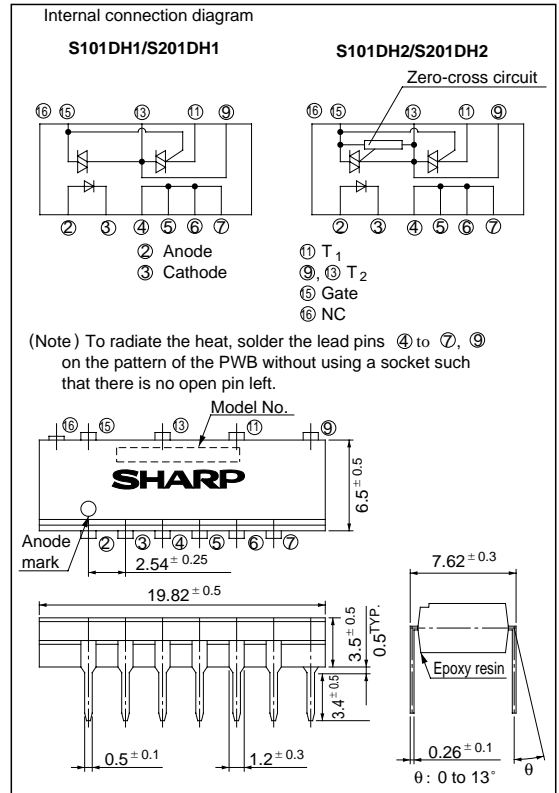

Electrical Characteristics

($T_a = 25^\circ\text{C}$)

Parameter		Symbol	Conditions	MIN.	TYP.	MAX.	Unit	
Input	Forward voltage	V_F	$I_F = 20\text{mA}$	-	1.2	1.4	V	
	Reverse current	I_R	$V_R = 3\text{V}$	-	-	10	μA	
Output	Repetitive peak OFF-state current	I_{DRM}	$V_{DRM} = \text{Rated}$	-	-	100	μA	
	ON-state voltage	V_T	$I_T = 1.5\text{A}$	-	-	1.7	V	
	Holding current	I_H	$V_D = 6\text{V}$	-	-	25	mA	
	Critical rate of rise of OFF-state voltage	S101DH1/S101DH2 S201DH1/S201DH2	dV/dt	$V_{DRM} = 1/\sqrt{2} \cdot \text{Rated}$	200	-	-	V/ μs
					100	-	-	
Zero-cross voltage	S101DH2/S201DH2	V_{OX}	Resistance load, $I_F = 15\text{mA}$	-	-	35	V	
Transfer characteristics	Minimum trigger current	I_{FT}	$V_D = 6\text{V}, R_L = 100\Omega$	-	-	10	mA	
	Isolation resistance	R_{ISO}	DC500V, 40 to 60% RH	5×10^{10}	10^{11}	-	Ω	
	Turn-on time	t_{on}	$V_D = 6\text{V}, R_L = 100\Omega$ $I_F = 20\text{mA}$	-	-	100	μs	

Fig. 1 RMS ON-state Current vs. Ambient Temperature

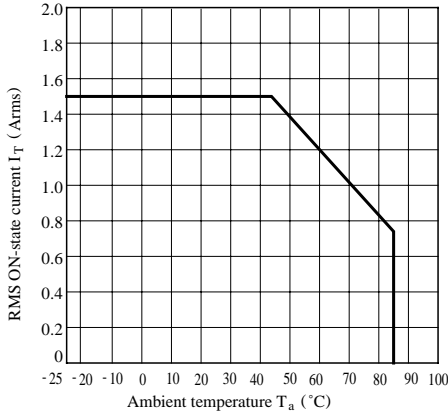

Fig. 2 Forward Current vs. Ambient Temperature

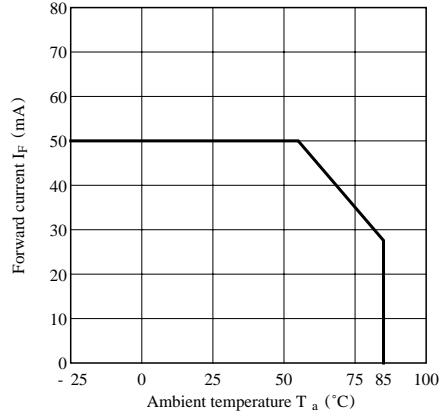

Fig. 3 Forward Current vs. Forward Voltage

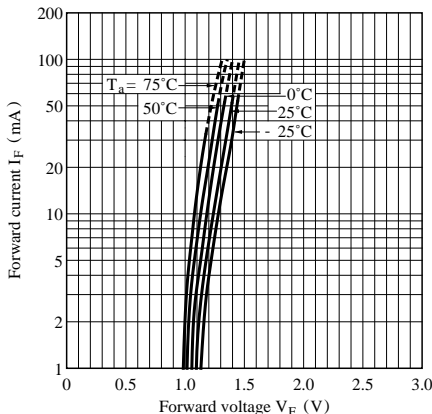

Fig. 4 Minimum Trigger Current vs. Ambient Temperature (Typical Value) (S101DH1)

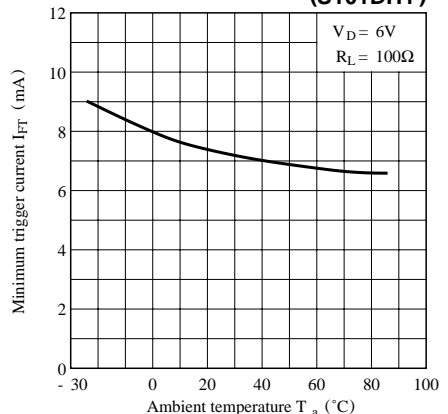

Fig. 5-a Minimum Trigger Current vs. Ambient Temperature (Typical Value) (S101DH2, S201DH2)

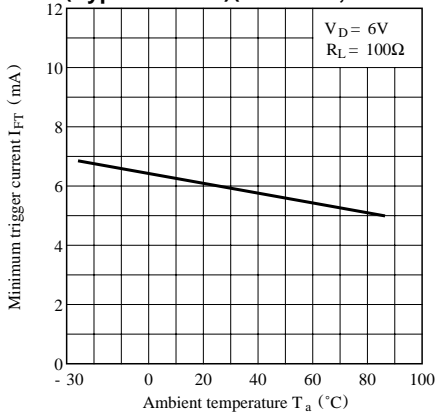

Fig. 5-b Minimum Trigger Current vs. Ambient Temperature (Typical Value) (S201DH1)

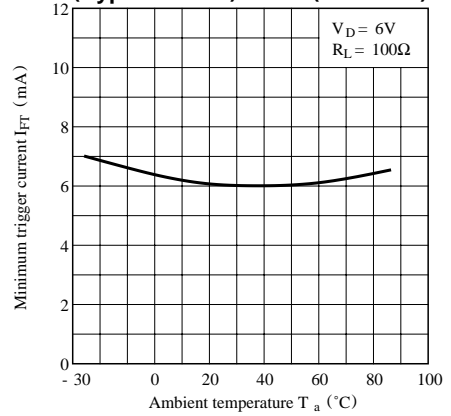

Fig. 6 ON-state Voltage vs. Ambient Temperature (Typical Value)

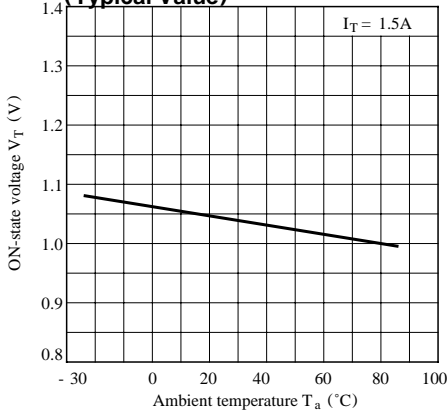

Fig. 7 Relative Holding Current vs. Ambient Temperature (Typical Value)

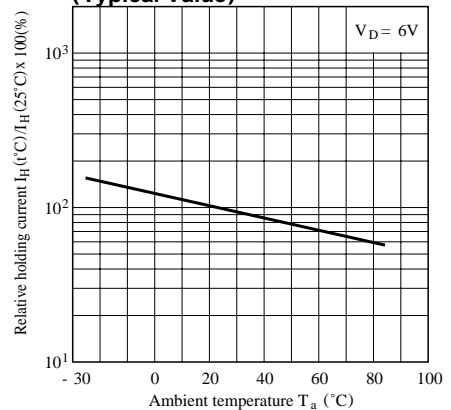

Fig. 8 ON-state Current vs. ON-State Voltage (Typical Value)

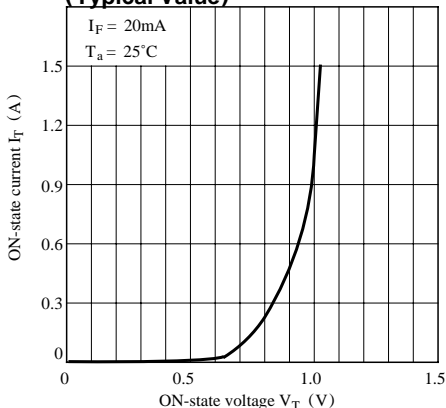
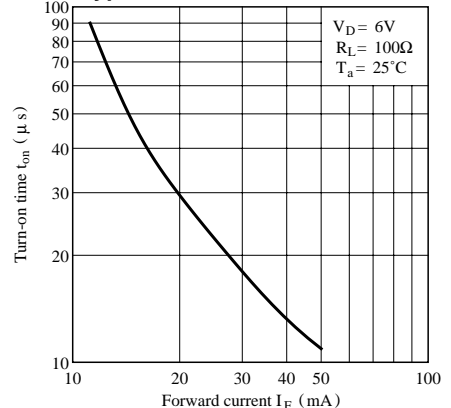
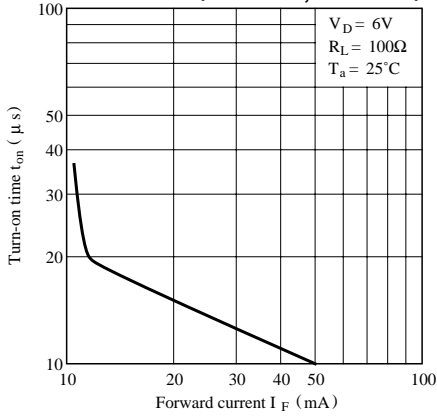

Fig. 9 Turn-on Time vs. Forward Current (Typical Value) (S101DH1)



**Fig.10 Turn-on Time vs. Forward Current
(Typical Value)
(S101DH2, S201DH2)**



**Fig.11 Turn-on Time vs. Forward Current
(Typical Value)
(S201DH1)**

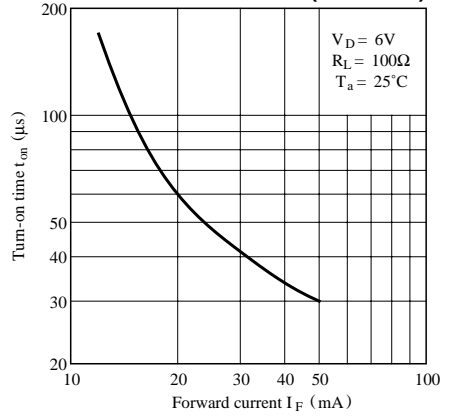

● Please refer to the chapter “Precautions for Use.”