

## Fast & Soft Recovery Diode

### DBA200UA60

$I_{F(AV)}= 2 \times 100A$ ,  $V_{RRM}=600V$ ,  $t_{rr}=150ns$

SanRex Fast & Soft Recovery Diode Module **DBA200UA60** is designed for applications requiring fast switching and soft recovery wave shape to reduce or eliminate the need for snubber components in the circuit. The modules are isolated for easy mounting with other components or a common heatsink.

#### Features

- \* Very Fast Reverse Recovery Time
- \* Soft Recovery Characteristics
- \* Low Forward Voltage Drop
- \* Compact isolated SOT-227 package

#### Typical Applications

- \* Welding and Plasma Cutting Machines
- \* DC chopper
- \* Rectifier in Switch Mode Power Supplies (SMPS)
- \* Uninterruptible Power Supplies (UPS)
- \* Free Wheeling Diode in converters and motor control circuits

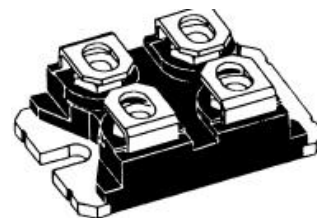

Isolated SOT-227 Package

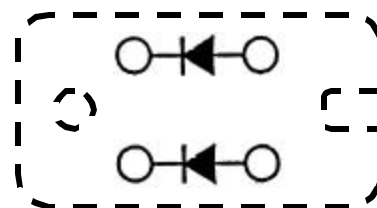

Internal schematic diagram

#### < Maximum Ratings >

$T_j = 25^\circ C$  (unless otherwise noted) per diode

Symbol	Item	Conditions	Ratings	Unit
$V_{RRM}$	Repetitive Peak Reverse Voltage		600	V
$V_{R(DC)}$	Reverse D.C. Voltage		480	V
$I_{F(AV)}$	Average Forward Current	D.C., $T_c = 89^\circ C$	100	A
$I_{FSM}$	Surge Forward Current	½ cycle, 60Hz, Peak value, non-repetitive	700	A
$I^2 t$	$I^2 t$ (for fusing)	Value for one cycle surge current	2100	A <sup>2</sup> s
$T_j$	Junction Temperature		-40 to +150	°C
$T_{stg}$	Storage Temperature		-40 to +125	°C
$V_{ISO}$	Isolation Voltage (R.M.S.)	A.C. 1 minute	2500	V
	Mounting Torque	Mounting M4	Recommended 1.0-1.4	N·m
		Terminal M4	Recommended 1.0-1.4	
	Mass	Typical Value	30	g

< Electrical Characteristics >

$T_j = 25^\circ\text{C}$  (unless otherwise noted) per diode

Symbol	Item	Conditions	Ratings			Unit
			Min.	Typ.	Max.	
$I_{RRM}$	Repetitive Peak Reverse Current	$V_R = V_{RRM}, T_j = 150^\circ\text{C}$			100	mA
$V_{FM}$	Forward Voltage Drop	$I_F = 100\text{A}$ , Inst. measurement		1.20	1.35	V
$t_{rr}$	Reverse Recovery Time	$I_F = 100\text{A}$ , $V_R = 300\text{V}$ , $-di/dt = 200\text{A}/\text{FS}$		150	250	ns
$R_{th(j-c)}$	Thermal Resistance	Junction to case			0.45	$^\circ\text{C}/\text{W}$

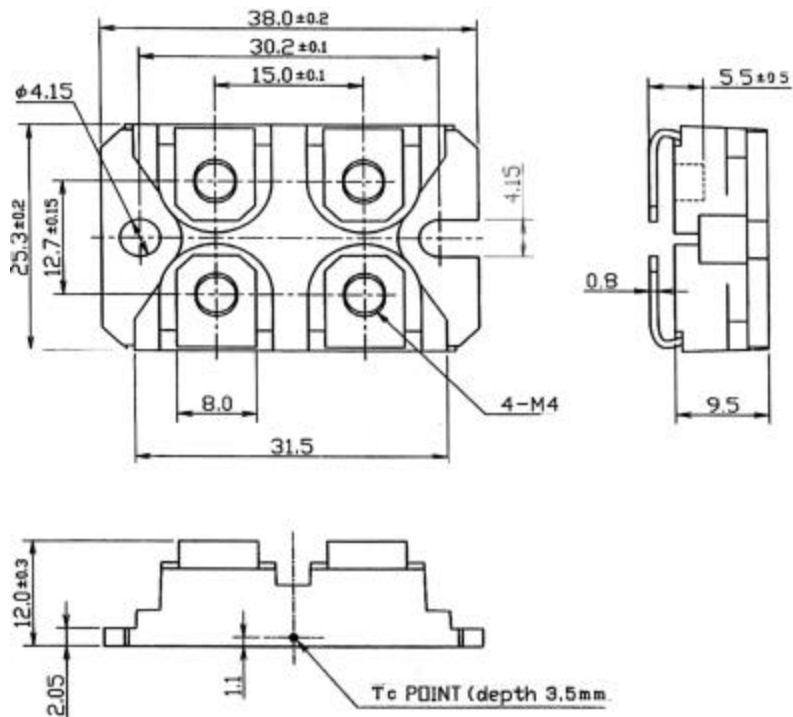

\* Dimensions in millimeters