

NPN Silicon Darlington Transistors

PZTA 13
PZTA 14

- For general AF applications
- High collector current
- High current gain
- Complementary types: PZTA 63
PZTA 64 (PNP)

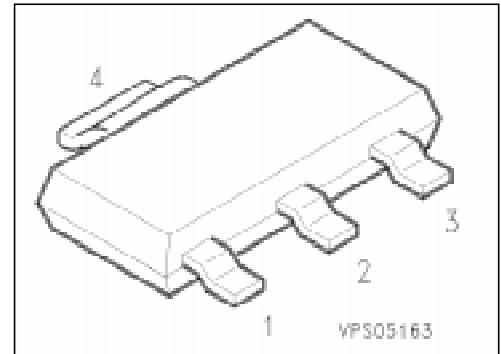

Type	Marking	Ordering Code (tape and reel)	Pin Configuration				Package ¹⁾
			1	2	3	4	
PZTA 13 PZTA 14	PZTA 13 PZTA 14	Q62702-Z2033 Q62702-Z2034	B	C	E	C	SOT-223

Maximum Ratings

Parameter	Symbol	Values	Unit
Collector-emitter voltage	V_{CES}	30	V
Collector-base voltage	V_{CB0}	30	
Emitter-base voltage	V_{EB0}	10	
Collector current	I_C	300	mA
Peak collector current	I_{CM}	500	
Base current	I_B	100	
Peak base current	I_{BM}	200	
Total power dissipation, $T_s = 124\text{ °C}$	P_{tot}	1.5	W
Junction temperature	T_j	150	°C
Storage temperature range	T_{stg}	- 65 ... + 150	

Thermal Resistance

Junction - ambient ²⁾	$R_{th\ JA}$	≤ 72	K/W
Junction - soldering point	$R_{th\ JS}$	≤ 17	

1) For detailed information see chapter Package Outlines.

2) Package mounted on epoxy pcb 40 mm × 40 mm × 1.5 mm/6 cm² Cu.

Electrical Characteristics

at $T_A = 25\text{ °C}$, unless otherwise specified.

Parameter	Symbol	Values			Unit
		min.	typ.	max.	

DC characteristics

Collector-emitter breakdown voltage $I_C = 100\text{ }\mu\text{A}$	$V_{(BR)CES}$	30	–	–	V
Collector-base breakdown voltage $I_C = 100\text{ }\mu\text{A}, I_B = 0$	$V_{(BR)CB0}$	30	–	–	
Emitter-base breakdown voltage $I_E = 10\text{ }\mu\text{A}, I_C = 0$	$V_{(BR)EB0}$	10	–	–	
Collector-base cutoff current $V_{CE} = 30\text{ V}, I_E = 0$ $V_{CE} = 30\text{ V}, I_E = 0, T_A = 150\text{ °C}$	I_{CB0}	–	–	100 10	nA μA
Emitter-base cutoff current $V_{EB} = 10\text{ V}, I_C = 0$	I_{EB0}	–	–	100	nA
DC current gain $I_C = 10\text{ mA}, V_{CE} = 5\text{ V}$ $I_C = 100\text{ mA}, V_{CE} = 5\text{ V}$	h_{FE}				–
Collector-emitter saturation voltage ¹⁾ $I_C = 100\text{ mA}, I_B = 0.1\text{ mA}$	V_{CEsat}	–	–	1.5	V
Base-emitter saturation voltage ¹⁾ $I_C = 100\text{ mA}, I_B = 0.1\text{ mA}$	V_{BEsat}	–	–	2.0	

AC characteristics

Transition frequency $I_C = 50\text{ mA}, V_{CE} = 5\text{ V}, f = 100\text{ MHz}$	f_T	125	–	–	MHz
---	-------	-----	---	---	-----

¹⁾ Pulse test conditions: $t \leq 300\text{ }\mu\text{s}, D = 2\%$.

Total power dissipation $P_{tot} = f(T_A^*; T_S)$

* Package mounted on epoxy

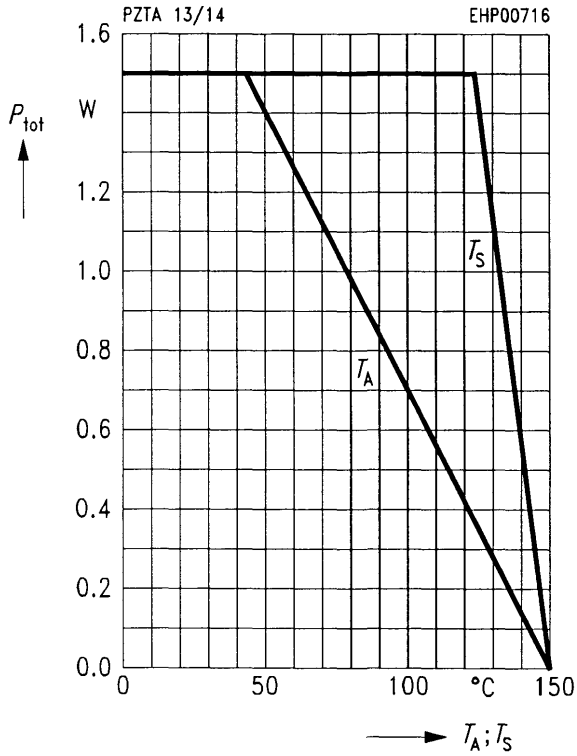

Transition frequency $f_T = f(I_C)$

$V_{CE} = 5 V, f = 100 \text{ MHz}$

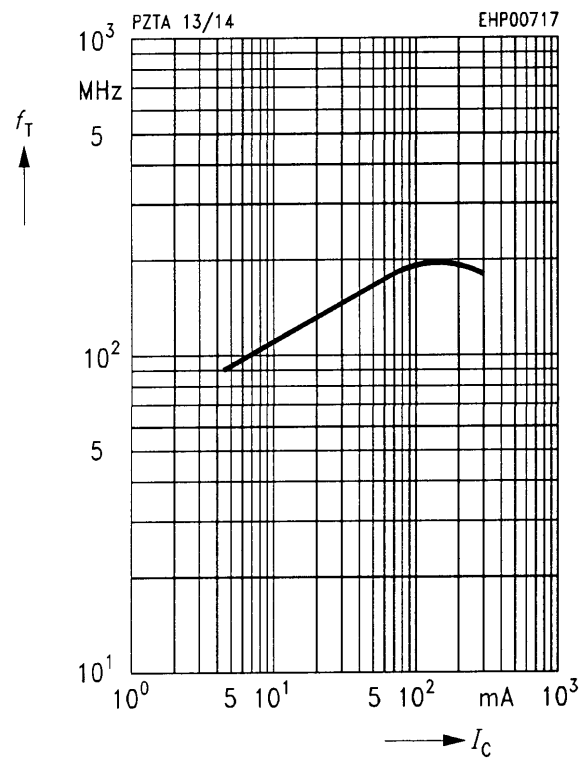

Collector cutoff current $I_{CB0} = f(T_A)$

$V_{CE} = 30 V$

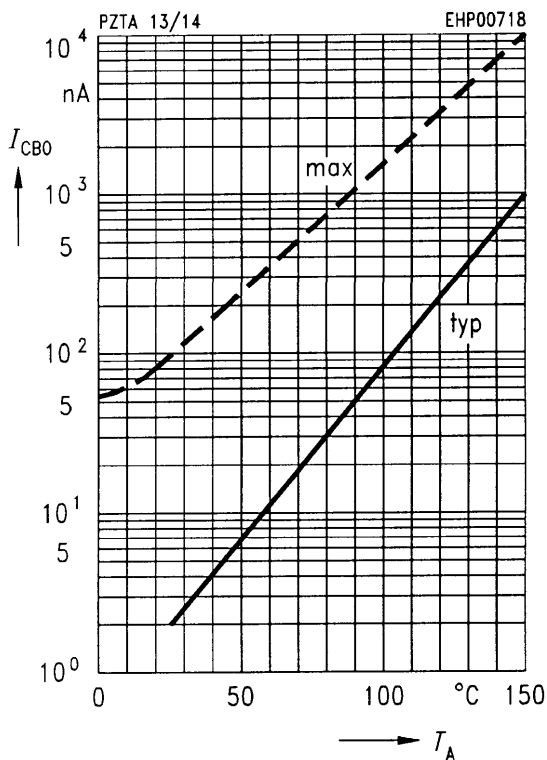

DC current gain $h_{FE} = f(I_C)$

$V_{CE} = 5 V$

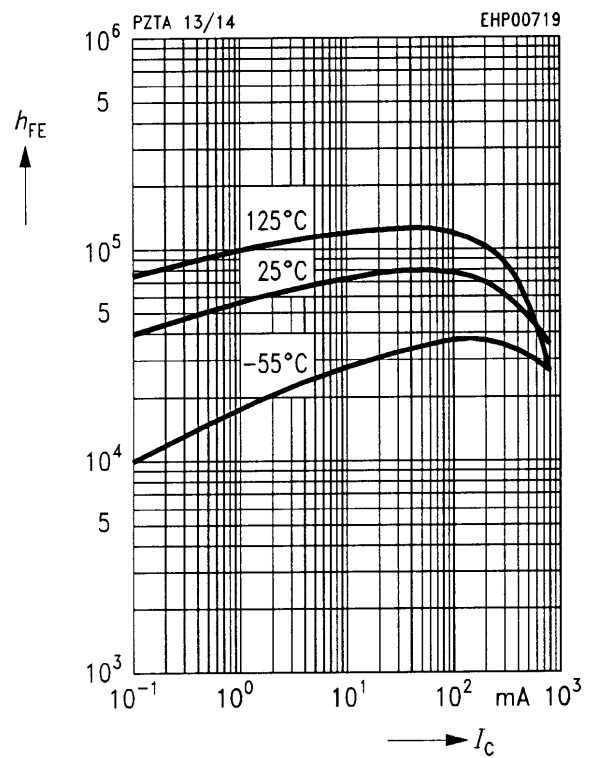

Collector-emitter saturation voltage

$I_C = f(V_{CE\ sat})$
 $h_{FE} = 1000$

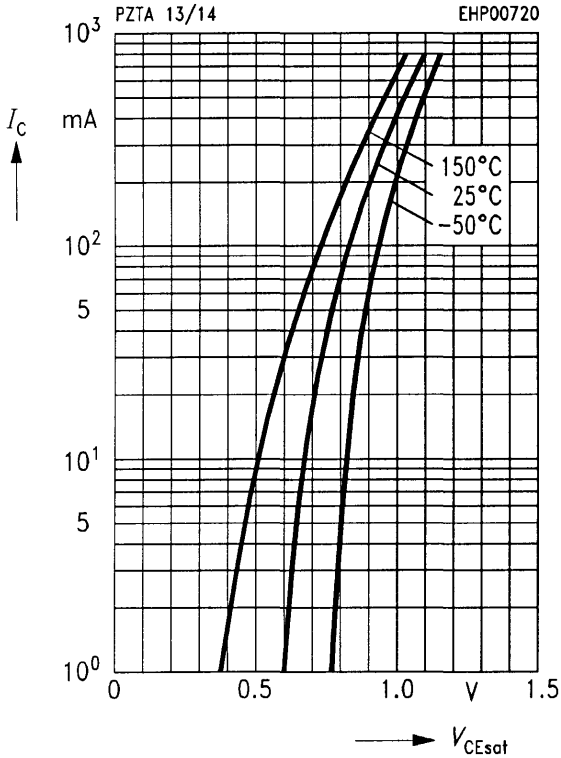

Base-emitter saturation voltage

$I_C = f(V_{BE\ sat})$
 $h_{FE} = 1000$

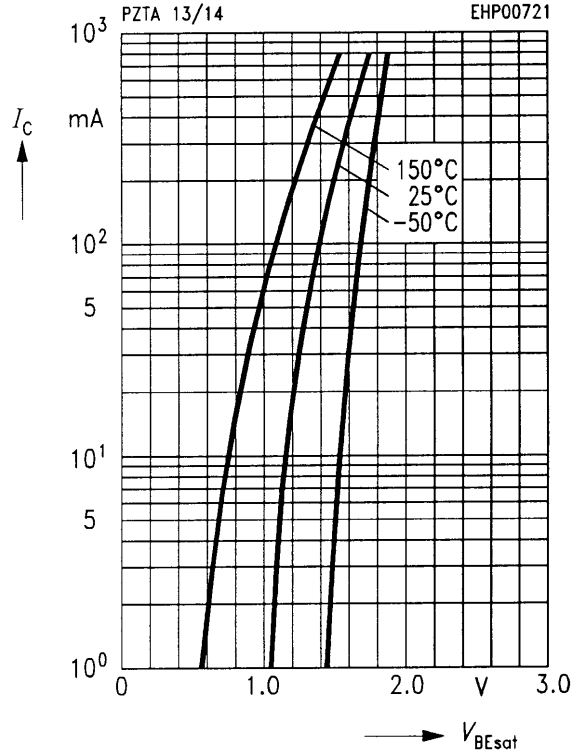

Permissible pulse load $P_{tot\ max} / P_{tot\ DC} = f(t_p)$

