

DBL 1035

PLL FM STEREO MULTIPLEX

DBL 1035 contains 2 functions of skip noise control and pilot cancel.

FUNCTIONS

- Pilot canceler.
- High-cut controller(HCC)
- Stereo noise controller(SNC)
- VCO oscillation stop
- Automatic selection between stereo and mono

FEATURES

- Low distortion
- Good ripple rejection of power supply
- Wide supply voltage range : $V_{CC} = 6.5V \sim 14V$
- Input signal voltage : $V_{IN} = 200mV \sim 300mV$

APPLICATIONS

- Car stereo radios

MAXIMUM RATINGS (Ta=25°C)

Characteristic	Symbol	Rating	Unit
Supply Voltage	V_{CC}	16	V
Lamp Driving Current	I_{LAMP}	30	mA
Power Dissipation	P_D	520	mW
Operating Temperature	T_{opr}	-20 ~ +70	°C
Storage Temperature	T_{stg}	-40 ~ +125	°C

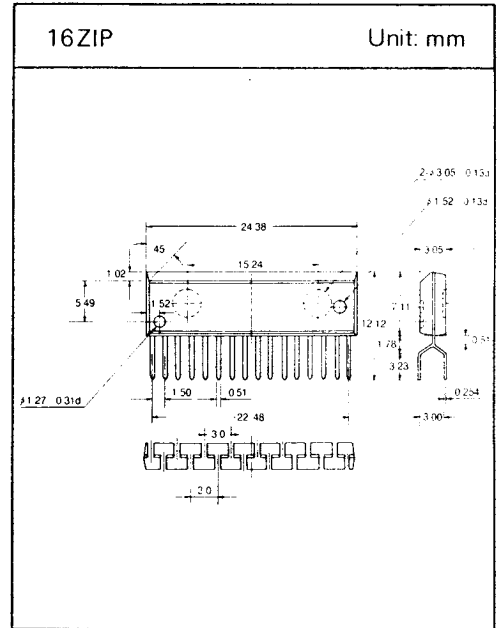

DBL 1035

BLOCK DIAGRAM AND APPLICATION CIRCUIT

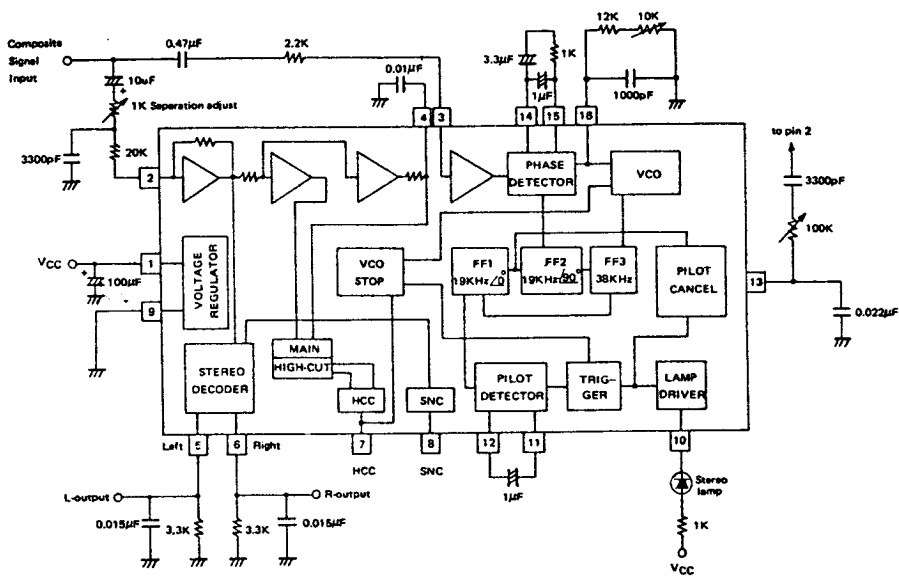

TEST CIRCUIT

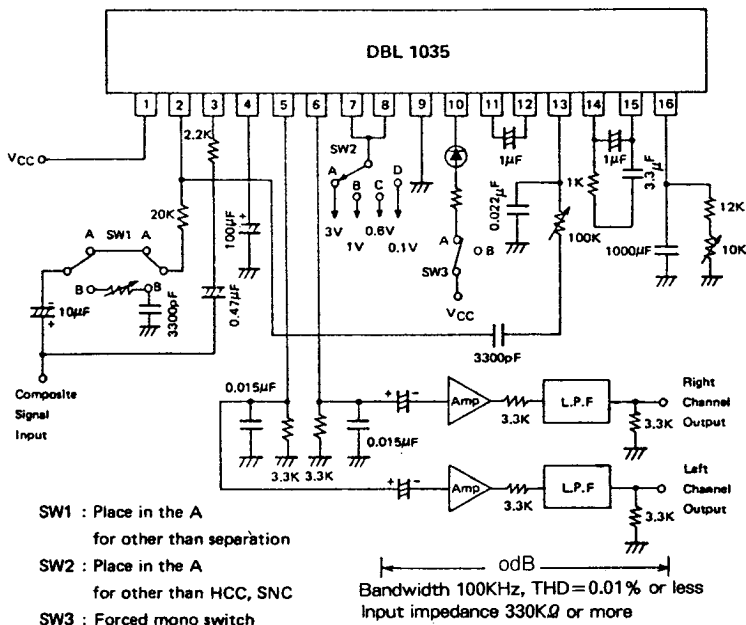

DBL 1035

ELECTRICAL CHARACTERISTICS

(Unless otherwise specified, $T_a = 25^\circ\text{C}$, $V_{CC} = 10\text{V}$, $V_{IN} = 300\text{mV}$, $f = 1\text{KHz}$, $L + R = 90\%$, $\text{Pilot} = 10\%$)

Characteristic	Symbol	Test Condition	Min.	Typ.	Max.	Unit
Quiescent Current	I_{CCO}	—	—	22	28	mA
Channel Separation	CH_{SEP}	—	45	50	—	dB
Monaural THD	THD_{MO}	$V_{IN} = 300\text{mV}(\text{mono})$	—	0.07	0.2	%
Stereo THD	THD_{ST}	—	—	0.07	0.2	%
Lamp Turn-on Level	V_{LAMP}	$L + R = 90\%$, $\text{Pilot} = 10\%$	60	85	120	mV
Capture Range	C.R.	—	—	± 3	—	%
Output voltage	V_{OUT}	—	150	215	300	mV
Signal to Noise Ratio	S/N	$R_g = 20\text{K}\Omega$	68	74	—	dB
		$R_g = 10\text{K}\Omega$	70	78	—	dB
Input Resistance	R_{IN}	—	—	20	—	$\text{K}\Omega$
SCA Rejection Ratio	SCA_{rej}	—	—	80	—	dB
Allowable Input Voltage	V_{IN}	$THD = 1\%$, $R_g = 20\text{K}\Omega$	700	900	—	mV
		$THD = 1\%$, $R_g = 10\text{K}\Omega$	—	450	—	mV
SNC Output Attenuation	$ATT(SNC)$	$V_b = 0.6\text{V}$, $L - R = 90\%$, $\text{Pilot} = 10\%$	-8.5	-3	-0.3	dB
SNC Output Voltage	$V_{OUT}(SNC)$	$V_b = 0.1\text{V}$, $L - R = 90\%$, $\text{Pilot} = 10\%$	—	—	5	mV
HCC Output Attenuation	$ATT(HCC1)$	$V_l = 0.6\text{V}$, $L + R = 10\%$, $\text{Pilot} = 10\%$	-15	-9	-0.5	dB
	$ATT(HCC2)$	$V_l = 1\text{V}$, $L + R = 10\%$, $\text{Pilot} = 10\%$	-2	—	0	dB
Power supply Ripple Rejection	R.R.	—	—	35	—	dB
VCO Stop Voltage	VCO_{STOP}	—	—	7.3	—	V
Channel Balance	CH_{BAL}	—	—	0.5	1.5	dB
Pilot Cancellation	P_{CAN}	—	20	27	—	dB
Stereo Lamp Current	I_{LAMP}	Min. stereo operating current	0.5	—	—	mA
Saturation Voltage(Pin 10)	V_{SAT}	$I_{LAMP} = 10\text{mA}$	—	1	—	V

DBL 1035

□ INFORMATION IN USING IC

1. Pilot cancelling circuit

A level-following type has been used. Once set, it can easily accommodate varying pilot modulation depths among stations. Cancelling signal is a sawtooth wave obtained by integrating R and C with a square wave that is proportionate in amplitude to pilot level.

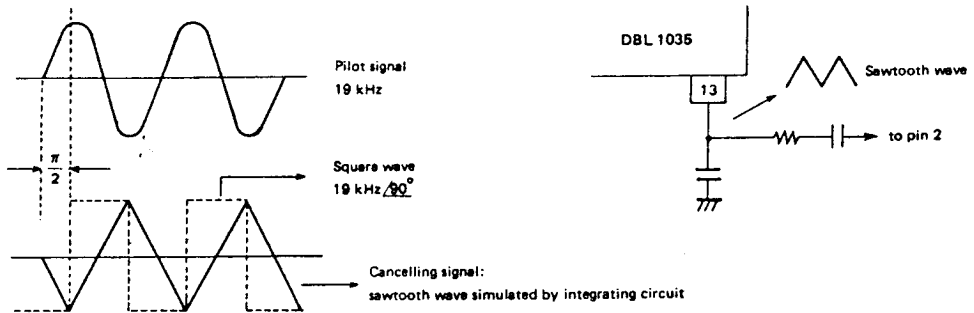

2. Separation adjustment

DBL1035 has separation only in a 25 to 30dB by itself. if a phase correction circuit is provided as shown below, it can have intrinsic separation characteristics, typically 50dB.

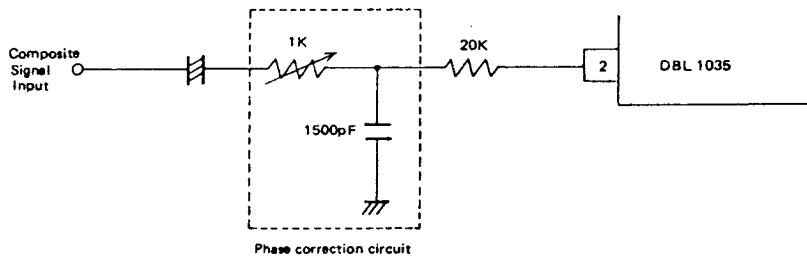

3. Adjusting the free running frequency

When connecting a frequency counter, use a timing set resistor and a semiset resistor. Connect the counter with a high impedance input to the connection between these resistors with a 100K Ω .

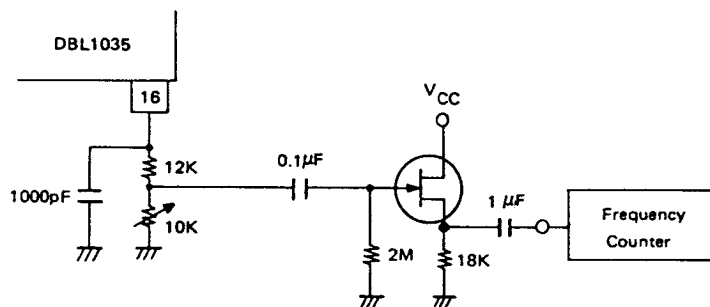

Adjust within 76.00 kHz \pm 50 Hz

DBL 1035

□ INFORMATION IN USING IC (continued)

4. Stereo noise control and High cut control

The DBL1035 has SNC and HCC terminals for improved S/N ratios when operating in weak radio fields. Noise unique to stereo FM in weak fields can be reduced by adjusting the SNC terminal. The HCC terminals permits further improvement of effective S/N ratios by lowering treble levels of FM noises in weak fields. (See Graph 2). Stereo deteriorates approximately 21.7dB(compared to Mono) in weak radio fields(See Graph 2). Generally, when S/N ratios deteriorate below 30 to 40dB, noises become quite noticeable.

1) Stereo noise control

Stereo S/N ratios deteriorate 21.7dB in weak radio fields but it can improved by varying stereo separation. The relation between separation and S/N improvement is shown in graph 5.

SNC improves S/N ratios in weak radio fields by varying separation. It varies subsignal demodulation level and controls separation. S/N ratios in region A of graph 2 can be maintained at about 40dB or better by using the IF stage signal. Ideal S/N ratios, starting from a point in region A for 40dB stereo S/N toward a point for 40dB mono S/N. SNC terminal(pin 8) is the base of a PNP transistor, so stereo mode is set when Pin 8 is open and mono mode is set when it is ground. SNC terminal control is effective only when locked with pilot signals and stereo indicator is lit. External parts should be chosen in large value that do not affect the IF stage meter output circuit because SNC control currents are small.(See Graph 6).

2) Design of external circuits for S N C

The recommended way of S N C characteristics to have smooth transition of separation from stereo to mono in region A of graph 2 is as follows.

- Separation vs. S/N enhancement(refer to graph 5).
- SNC terminal voltages vs: separation characteristics(refer to graph 3).

3) Highcut control

In region B where S/N deteriorates to 40dB or worse even for monaural, the S/N as sensed by the human ear can be enhanced by suppressing levels at frequencies above approximately 7KHz. Graph 7 shows MPX output frequency characteristics(mono) provided by voltages impressed on pin 7. Frequency characteristics for a 100% high cut can be designated by an external capacitor connected to pin 4. The designation is made by the 5K Ω and the C time constant.

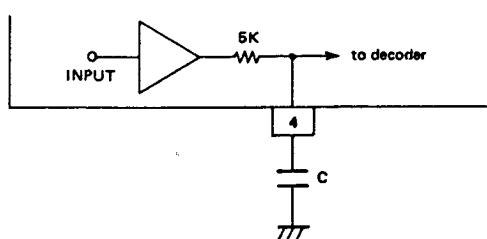

C(μ F)	Attenuation at 10KHz (dB)
0.01	-11
0.033	-21
0.047	-25
0.068	-28

DBL 1035

□ INFORMATION IN USING IC (continued)

Graph 8 shows the relation between voltages impressed on pin 7 and rates(%) of H C C .

4) Using the H C C terminal for muting.

Muting function is feasible by utilizing H C C as shown below.

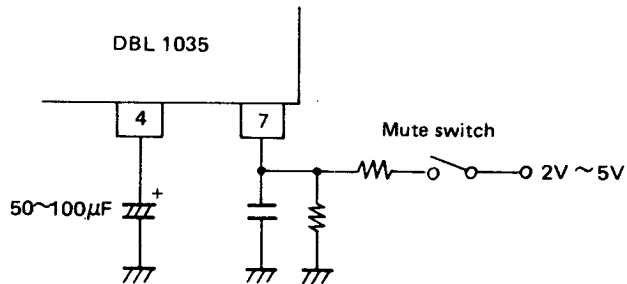

5) VCO damping

VCO oscillations can be damped by applying a voltage not less than 7V to the HCC terminal(pin7) to induce a mono mode. And then both SNC and HCC are in an off mode.(See Graph 9)

6) Forced mono

By disconnecting LED lamp at pin 10 from V_{CC} lamp, forced mono function can be attained. And then Stereo lamp is turned off but Pilot cancel and HCC function are held.

TYPICAL PERFORMANCE CHARACTERISTICS

Sample Weak Radio Field S/N Improvements by the system (Graph 1)

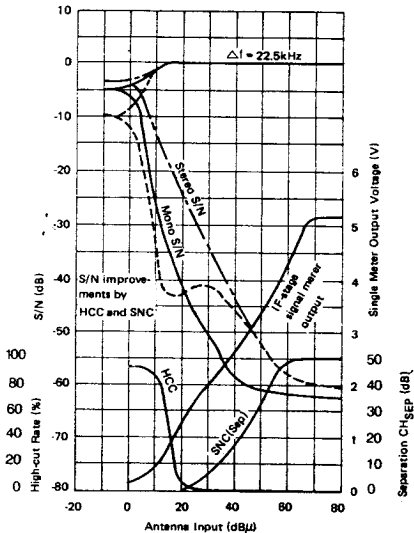

SNC and HCC Operating Regions (Graph 2)

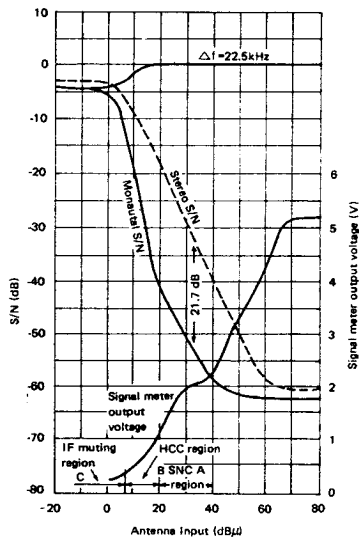

SNC Characteristics (Graph 3a)

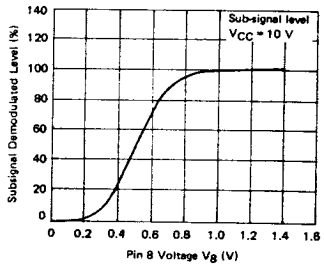

CH_{SEP}-V₈ (Graph 3b)

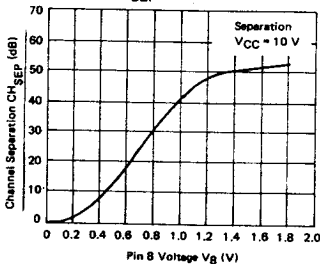

CH_{SEP}-V_{CC} (Graph 4)

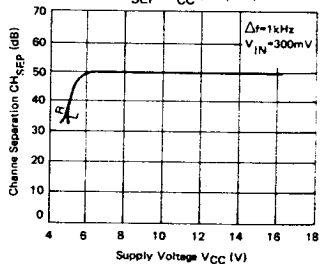

CH_{SEP}-S/N Improvement (Graph 5)

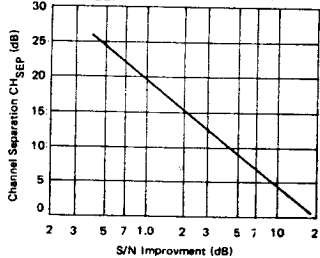

SNC, HCC Control Pin Current (Graph 6)

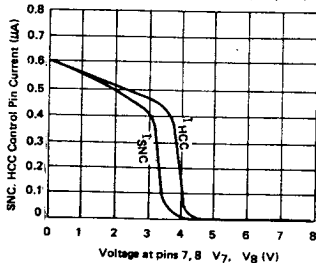

ATT-f (Graph 7)

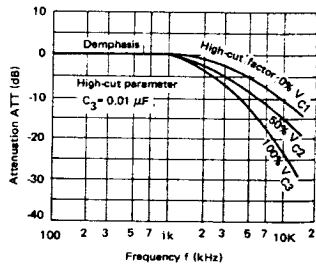

DBL 1035

□ TYPICAL PERFORMANCE CHARACTERISTICS (continued)

