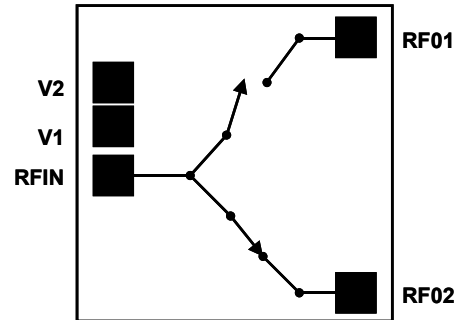

SPDT GaAs High Isolation Absorptive Switch DC-4 GHz

Features:

- ◆ Available as RF Known Good Die
- ◆ Excellent low control voltage performance
- ◆ Excellent harmonic performance
- ◆ Very high isolation >49dB typ. up to 4GHz
- ◆ Very low Tx Insertion loss <1.0 dB at 4GHz

Functional Schematic

Description and Applications:

The FMS2013 is a low loss, high power, linear single-pole double-throw Gallium Arsenide switch designed for general purpose applications over the frequency range DC-4GHz. The die is fabricated using the Filtronic FL05 0.5 μ m switch process technology which offers market leading performance optimised for switch applications.

Electrical Specifications: ($T_{OP} = 25^{\circ}C, V_{ctrl} = 0V/2.5V, Z_{IN} = Z_{OUT} = 50\Omega$)

Parameter	Test Conditions	Min	Typ	Max	Units
Tx Insertion Loss	4GHz		1.0		dB
Rx Insertion Loss	4GHz		1.0		dB
Return Loss	4GHz		15		dB
VSWR On State	4GHz		1:1.3		
VSWR Off State	4GHz		1:1.4		
Isolation at 4 GHz	4GHz		49		dB
2nd Harmonic Level	3GHz, Pin = 21dBm, Vctrl = 3V		-72		dBc
	3GHz, Pin = 27dBm, Vctrl = 5V		-68		dBc
Switching speed	Pin = 21dBm, 10% to 90% RF		30		ns

Note: External DC blocking capacitors are required on all RF ports (typ: 47pF).

Absolute Maximum Ratings:

Parameter	Symbol	Absolute Maximum
Max Input Power	P _{in}	+30dBm
Control Voltage	V _{ctrl}	+5V
Operating Temperature	T _{OP}	-40°C to +100°C
Storage Temperature	T _{OP}	-55°C to +150°C

Note: Exceeding any one of these absolute maximum ratings may cause permanent damage to the device.

Truth Table:

V _{ctrl1}	V _{ctrl2}	RFIN-RF01	RFIN-RF02
High	Low	On	Off
Low	High	Off	On

Note: 'High' = >2.5V & <5V
'Low' = <0.2V

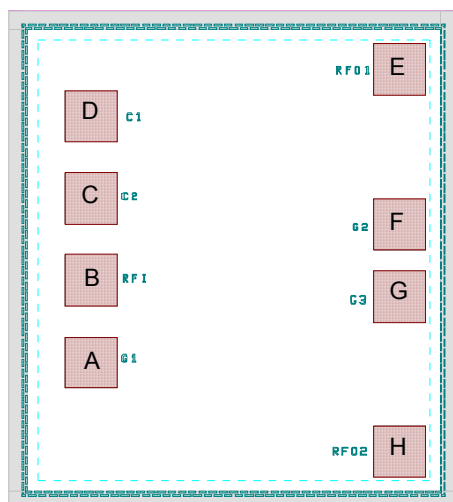
Pad and Die Layout:

Pad Reference	Pad Name	Description	Pin Coordinates (μm)
A	G1	GND1	159 , 286
B	RFI	RFIN	159 , 446
C	C2	Vctrl1	159 , 606
D	C1	Vctrl2	159 , 766
E	RFO1	RFO1	757 , 857
F	G2	GND2	757 , 555
G	G3	GND3	757 , 414
H	RFO2	RFO2	757 , 112

Note: Co-ordinates are referenced from the bottom left hand corner of the die to the centre of the bond pad opening

Die Size (μm)	Die Thickness (μm)	Min. Bond Pad Pitch (μm)	Min. Bond pad Opening (μm)
870 x 970	150	141	94 x 94

Typical Measured Performance Curves Mounted on Evaluation Board:

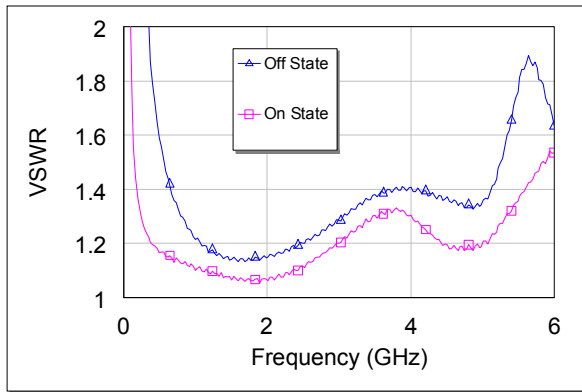

VSWR vs. Frequency

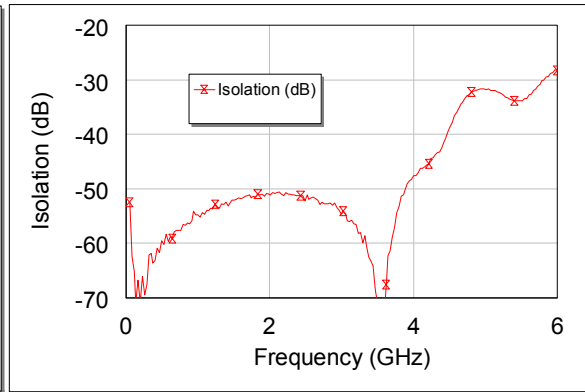

Isolation vs. Frequency

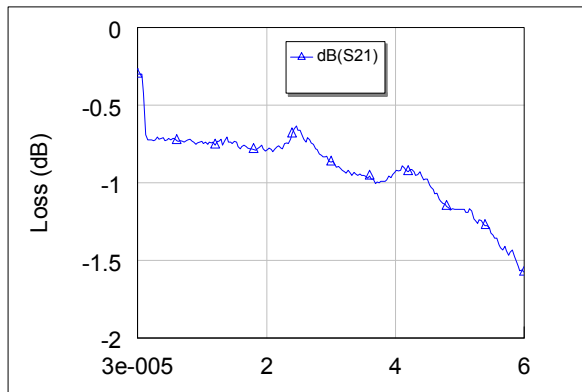

Insertion Loss vs. Frequency

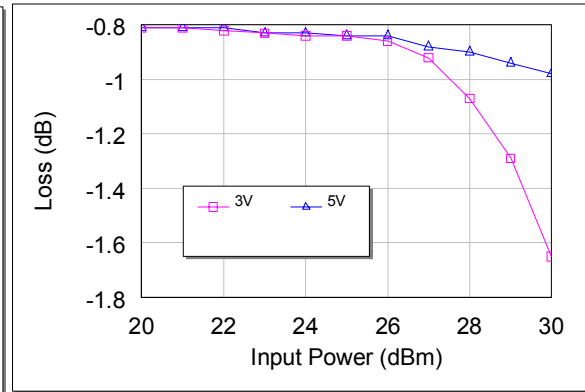

Insertion Loss vs. Power

Evaluation Board:

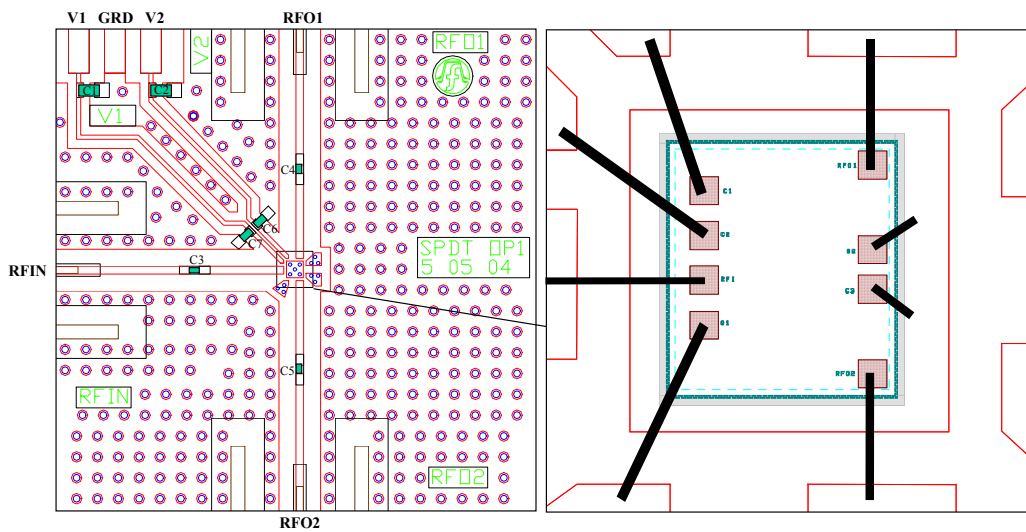

Label	Component
C1, C2	Capacitor, 470pF, 0603
C3, C4, C5	Capacitor, 100pF, 0202
C6, C7	Capacitor, 47pF, 0402

Evaluation Board De-Embedding Data (Measured):

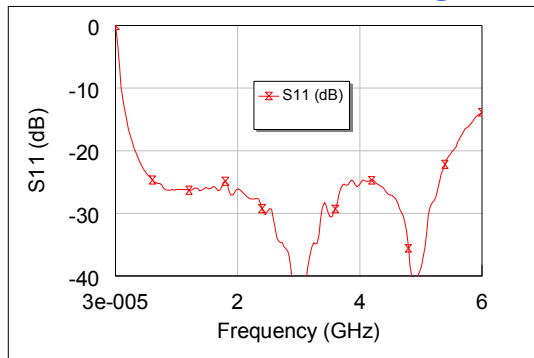

Return Loss vs. Frequency

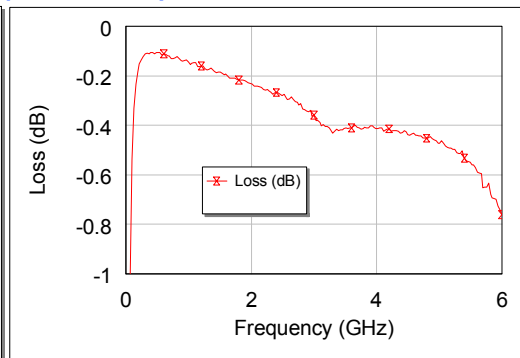

Insertion Loss vs. Frequency

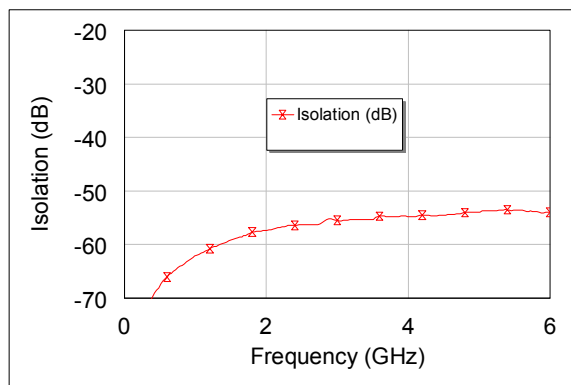

Isolation vs. Frequency

Ordering Information:

Part Number	Description
FMS2013-000-WP	Die – waffle pak
FMS2013-000-GP	Die – gel pak
FMS2013-000-EB	Die mounted on evaluation board
FMS2013-000-FF	Wafer mounted on film frame

Preferred Assembly Instructions:

GaAs devices are fragile and should be handled with great care. Specially designed collets should be used where possible.

The back of the die is not metallised and the recommended mounting method is by the use of conductive epoxy. Epoxy should be applied to the attachment surface uniformly and sparingly to avoid encroachment of epoxy on to the top face of the die and ideally should not exceed half the chip height. For automated dispense Ablestick LMISR4 is recommended and for manual dispense Ablestick 84-1 LMI or 84-1 LMIT are recommended. These should be cured at a temperature of 150°C for 1 hour in an oven especially set aside for epoxy curing only. If possible the curing oven should be flushed with dry nitrogen.

This part has gold (Au) bond pads requiring the use of gold (99.99% pure) bondwire. It is recommended that 25.4µm diameter gold wire is used. Thermosonic ball bonding is preferred. A nominal stage temperature of 150°C and a bonding force of 40g has been shown to give effective results for 25µm wire. Ultrasonic energy shall be kept to a minimum. For this bonding technique, stage temperature should not be raised above 200°C and bond force should not be raised above 60g. Thermosonic wedge bonding and thermocompression wedge bonding can also be used to achieve good wire bonds.

Bonds should be made from the die first and then to the mounting substrate or package. The physical length of the bondwires should be minimised especially when making RF or ground connections.

Handling Precautions:

To avoid damage to the devices care should be exercised during handling. Proper Electrostatic Discharge (ESD) precautions should be observed at all stages of storage, handling, assembly, and testing. These devices should be treated as Class 1A (0-500 V) as defined in JEDEC Standard No. 22-A114-B. Further information on ESD control measures can be found in MIL-STD-1686 and MIL-HDBK-263.

Disclaimers:

This product is not designed for use in any space based or life sustaining/supporting equipment.