

16-BIT, 750-kHz, UNIPOLAR INPUT, MICRO POWER SAMPLING ANALOG-TO-DIGITAL CONVERTER WITH PARALLEL INTERFACE

FEATURES

- 750-KSPS Sample Rate
- High Linearity:
 - +0.9 LSB INL Typ, ± 1.5 LSB Max
 - -0.4/+0.6 LSB DNL Typ, ± 1 LSB Max
- Onboard Reference Buffer and Conversion Clock
- 0 V to 4.096 V Unipolar Inputs
- Low Noise: 88 dB SNR
- High Dynamic Range: 110 dB SFDR
- Very Low Offset and Offset Drift
- Low Power: 130 mW at 750 KSPS
- Wide Buffer Supply, 2.7 V to 5.25 V
- Flexible 8-/16-Bit Parallel Interface
- Direct Pin Compatible With ADS8381/ADS8383
- 48-Pin TQFP Package

APPLICATIONS

- Medical Instruments
- Optical Networking
- Transducer Interface
- High Accuracy Data Acquisition Systems
- Magnetometers

DESCRIPTION

The ADS8371 is an 16-bit, 750 kHz A/D converter. The device includes a 16-bit capacitor-based SAR A/D converter with inherent sample and hold. The ADS8371 offers a full 16-bit interface or an 8-bit bus option using two read cycles.

The ADS8371 is available in a 48-lead TQFP package and is characterized over the industrial -40°C to 85°C temperature range.

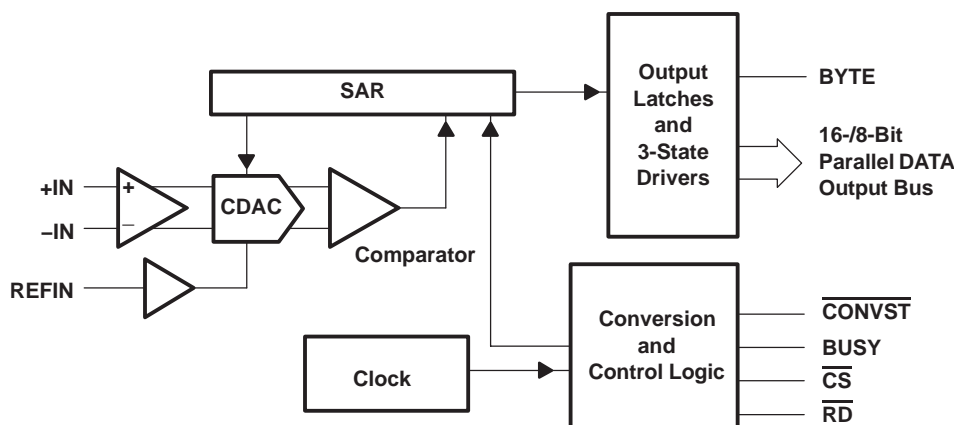

Please be aware that an important notice concerning availability, standard warranty, and use in critical applications of Texas Instruments semiconductor products and disclaimers thereto appears at the end of this data sheet.

ADS8371

SLAS390A – JUNE 2003 – REVISED DECEMBER 2003



These devices have limited built-in ESD protection. The leads should be shorted together or the device placed in conductive foam during storage or handling to prevent electrostatic damage to the MOS gates.

ORDERING INFORMATION

MODEL	MAXIMUM INTEGRAL LINEARITY (LSB)	MAXIMUM DIFFERENTIAL LINEARITY (LSB)	NO MISSING CODES RESOLUTION (BIT)	PACKAGE TYPE	PACKAGE DESIGNATOR	TEMPERATURE RANGE	ORDERING INFORMATION	TRANSPORT MEDIA QUANTITY
ADS8371I	±2.5	-1/1.5	16	48 Pin TQFP	PFB	-40°C to 85°C	ADS8371IPFBT	Tape and reel 250
							ADS8371IPFBR	Tape and reel 1000
ADS8371IB	±1.5	±1	16	48 Pin TQFP	PFB	-40°C to 85°C	ADS8371IBPFBT	Tape and reel 250
							ADS8371IBPFBR	Tape and reel 1000

NOTE: For the most current specifications and package information, refer to our website at www.ti.com.

ABSOLUTE MAXIMUM RATINGS

over operating free-air temperature range unless otherwise noted⁽¹⁾

		UNIT
Voltage	+IN to AGND	-0.4 V to +VA + 0.1 V
	-IN to AGND	-0.4 V to 0.5 V
Voltage range	+VA to AGND	-0.3 V to 7 V
	+VBD to BDGND	-0.3 V to 7 V
	+VA to +VBD	-0.3 V to 2.55 V
Digital input voltage to BDGND		-0.3 V to +VBD + 0.3 V
Digital output voltage to BDGND		-0.3 V to +VBD + 0.3 V
Operating free-air temperature range, T _A		-40°C to 85°C
Storage temperature range, T _{stg}		-65°C to 150°C
Junction temperature (T _J max)		150°C
TQFP package	Power dissipation	(T _J Max - T _A)/θ _{JA}
	θ _{JA} thermal impedance	86°C/W
Lead temperature, soldering	Vapor phase (60 sec)	215°C
	Infrared (15 sec)	220°C

(1) Stresses beyond those listed under “absolute maximum ratings” may cause permanent damage to the device. These are stress ratings only, and functional operation of the device at these or any other conditions beyond those indicated under “recommended operating conditions” is not implied. Exposure to absolute-maximum-rated conditions for extended periods may affect device reliability.

SPECIFICATIONS
 $T_A = -40^{\circ}\text{C}$ to 85°C , $+V_A = 5\text{ V}$, $+V_{BD} = 3\text{ V}$ or 5 V , $V_{\text{ref}} = 4.096\text{ V}$, $f_{\text{SAMPLE}} = 750\text{ kHz}$ (unless otherwise noted)

PARAMETER	TEST CONDITIONS	ADS8371IB			ADS8371I			UNIT
		MIN	TYP	MAX	MIN	TYP	MAX	
Analog Input								
Full-scale input voltage (see Note 1)	+IN – –IN	0		V_{ref}	0		V_{ref}	V
Absolute input voltage	+IN	–0.2		$V_{\text{ref}} + 0.2$	–0.2		$V_{\text{ref}} + 0.2$	V
	–IN	–0.2		0.2	–0.2		0.2	
Input capacitance			45			45		pF
Input leakage current			1			1		nA
System Performance								
Resolution			16			16		Bits
No missing codes		16			16			Bits
Integral linearity (see Notes 2 and 3)		–1.5	–0.8/0.9	1.5	–2.5		2.5	LSB
Differential linearity		–1	–0.4/0.6	1	–1		1.5	LSB
Offset error		–0.75	± 0.25	0.75	–1	± 0.5	1	mV
Gain error (see Note 4)		–0.075		0.075	–0.15		0.15	%FS
Noise			60			60		$\mu\text{V RMS}$
Power supply rejection ratio	At 3FFFFh output code		75			75		dB
Sampling Dynamics								
Conversion time				1.13			1.13	μs
Acquisition time		0.2			0.2			μs
Throughput rate				750			750	kHz
Aperture delay			4			4		ns
Aperture jitter			15			15		ps
Step response			150			150		ns
Over voltage recovery			150			150		ns

(1) Ideal input span, does not include gain or offset error.

(2) LSB means least significant bit

(3) This is endpoint INL, not best fit.

(4) Measured relative to an ideal full-scale input (+IN – –IN) of 4.096 V

ADS8371

SLAS390A – JUNE 2003 – REVISED DECEMBER 2003

SPECIFICATIONS (CONTINUED)

 $T_A = -40^{\circ}\text{C}$ to 85°C , $+V_A = +5\text{ V}$, $+V_{BD} = 3\text{ V}$ or 5 V , $V_{\text{ref}} = 4.096\text{ V}$, $f_{\text{SAMPLE}} = 750\text{ kHz}$ (unless otherwise noted)

PARAMETER	TEST CONDITIONS	ADS8371IB			ADS8371I			UNIT
		MIN	TYP	MAX	MIN	TYP	MAX	UNIT
Dynamic Characteristics								
Total harmonic distortion (THD) (see Note 1)	1 kHz		-106			-100		dB
	10 kHz		-99			-96		
	50 kHz		-92			-90		
	100 kHz		-90			-88		
Signal to noise ratio (SNR) (see Note 1)	1 kHz		87.7			87		dB
	10 kHz		87.5			87		
	50 kHz		87.2			87		
	100 kHz		87			87		
Signal to noise + distortion (SINAD) (see Note 1)	1 kHz		87.6			87		dB
	10 kHz		87			86		
	50 kHz		86			85		
	100 kHz		85			84		
Spurious free dynamic range (SFDR) (see Note 1)	1 kHz		110			106		dB
	10 kHz		100			97		
	50 kHz		95			92		
	100 kHz		94			90		
-3dB Small signal bandwidth			3			3		MHz
Voltage Reference Input								
Reference voltage at REFIN, V_{ref}		2.5	4.096	4.2	2.5	4.096	4.2	V
Reference resistance (see Note 2)			500			500		k Ω
Reference current drain	$f_s = 750\text{ kHz}$			1			1	mA

(1) Calculated on the first nine harmonics of the input frequency

 (2) Can vary $\pm 20\%$

SPECIFICATIONS (CONTINUED)
 $T_A = -40^\circ\text{C}$ to 85°C , $+V_A = +5\text{ V}$, $+V_{BD} = 3\text{ V}$ or 5 V , $V_{\text{ref}} = 4.096\text{ V}$, $f_{\text{SAMPLE}} = 750\text{ kHz}$ (unless otherwise noted)

PARAMETER		TEST CONDITIONS	MIN	TYP	MAX	UNIT
Digital Input/Output						
Logic family			CMOS			
Logic level	V_{IH}	$I_{IH} = 5\ \mu\text{A}$	$+V_{BD} - 1$		$+V_{BD} + 0.3$	V
	V_{IL}	$I_{IL} = 5\ \mu\text{A}$	-0.3		0.8	
	V_{OH}	$I_{OH} = 2\text{ TTL loads}$	$+V_{BD} - 0.6$			
	V_{OL}	$I_{OL} = 2\text{ TTL loads}$			0.4	
Data format			Straight Binary			
Power Supply Requirements						
Power supply voltage	+VBD Buffer supply		2.7	3.3	5.25	V
	+VA Analog Supply		4.75	5	5.25	V
Supply current, 750-kHz sample rate (1)				26	28	mA
Power dissipation, 750-kHz sample rate (1)				130	140	mW
Temperature Range						
Operating free-air			-40		85	$^\circ\text{C}$

(1) This includes only +VA current. +VBD current is typical 1 mA with 5 pF load capacitance on all output pins.

ADS8371

SLAS390A – JUNE 2003 – REVISED DECEMBER 2003

TIMING CHARACTERISTICS

 All specifications typical at -40°C to 85°C , $+V_A = +V_{BD} = 5\text{ V}$ (see Notes 1, 2, and 3)

PARAMETER		MIN	TYP	MAX	UNIT
t_{CONV}	Conversion time			1.13	μs
t_{ACQ}	Acquisition time	0.2			μs
t_{HOLD}	Sampling capacitor hold time			25	ns
t_{pd1}	$\overline{\text{CONVST}}$ low to conversion started (BUSY high)			45	ns
t_{pd2}	Propagation delay time, End of conversion to BUSY low			20	ns
t_{pd3}	Propagation delay time, from start of conversion (internal state) to rising edge of BUSY			20	ns
t_{w1}	Pulse duration, $\overline{\text{CONVST}}$ low	40		400	ns
t_{su1}	Setup time, $\overline{\text{CS}}$ low to $\overline{\text{CONVST}}$ low	20			ns
t_{w2}	Pulse duration, $\overline{\text{CONVST}}$ high	20			ns
	$\overline{\text{CONVST}}$ falling edge jitter			10	ps
t_{w3}	Pulse duration, BUSY signal low	Min(t_{ACQ})			μs
t_{w4}	Pulse duration, BUSY signal high			1.13	μs
t_{h1}	Hold time, First data bus data transition ($\overline{\text{CS}}$ low for read cycle, or $\overline{\text{RD}}$ or BYTE input changes) after $\overline{\text{CONVST}}$ low	40		400	ns
t_{d1}	Delay time, $\overline{\text{CS}}$ low to $\overline{\text{RD}}$ low	0			ns
t_{su2}	Setup time, $\overline{\text{RD}}$ high to $\overline{\text{CS}}$ high	0			ns
t_{w5}	Pulse duration, $\overline{\text{RD}}$ low time	50			ns
t_{en}	Enable time, $\overline{\text{RD}}$ low (or $\overline{\text{CS}}$ low for read cycle) to data valid			20	ns
t_{d2}	Delay time, data hold from $\overline{\text{RD}}$ high	5			ns
t_{d3}	Delay time, BUS18/16 or BYTE rising edge or falling edge to data valid	10		20	ns
t_{w6}	Pulse duration, $\overline{\text{RD}}$ high	20			ns
t_{w7}	Pulse duration, $\overline{\text{CS}}$ high time	20			ns
t_{h2}	Hold time, last $\overline{\text{CS}}$ rising edge or changes of $\overline{\text{RD}}$ or BYTE to $\overline{\text{CONVST}}$ falling edge	125			ns
t_{pd4}	Propagation delay time, BUSY falling edge to next $\overline{\text{RD}}$ (or $\overline{\text{CS}}$ for read cycle) falling edge		Max(t_{d5})		ns
t_{su3}	Setup time, BYTE transition to $\overline{\text{RD}}$ falling edge	10			ns
t_{h3}	Hold time, BYTE transition to $\overline{\text{RD}}$ falling edge	10			ns
t_{dis}	Disable time, $\overline{\text{RD}}$ High ($\overline{\text{CS}}$ high for read cycle) to 3-stated data bus			20	ns
t_{d5}	Delay time, BUSY low to MSB data valid			30	ns
t_{su5}	Setup time, BYTE transition to next BYTE transition	50			ns
$t_{\text{su(AB)}}$	Setup time, from the falling edge of $\overline{\text{CONVST}}$ (used to start the valid conversion) to the next falling edge of $\overline{\text{CONVST}}$ (when $\overline{\text{CS}} = 0$ and $\overline{\text{CONVST}}$ used to abort) or to the next falling edge of $\overline{\text{CS}}$ (when $\overline{\text{CS}}$ is used to abort).	65		700	ns
$t_{\text{f(}(\overline{\text{CONVST}})$	Falling time, ($\overline{\text{CONVST}}$ falling edge)	10		30	ns
t_{su6}	Setup time, $\overline{\text{CS}}$ falling edge to $\overline{\text{CONVST}}$ falling edge when $\overline{\text{RD}} = 0$	125			ns

 (1) All input signals are specified with $t_r = t_f = 5\text{ ns}$ (10% to 90% of $+V_{BD}$) and timed from a voltage level of $(V_{IL} + V_{IH})/2$ except for $\overline{\text{CONVST}}$.

(2) See timing diagrams.

(3) All timing are measured with 20 pF equivalent loads on all data bits and BUSY pins.

TIMING CHARACTERISTICS

All specifications typical at -40°C to 85°C , $+V_A = 5\text{ V}$, $+V_{BD} = 3\text{ V}$ (see Notes 1, 2, and 3)

PARAMETER		MIN	TYP	MAX	UNIT
t _{CONV}	Conversion time			1.13	μs
t _{ACQ}	Acquisition time	0.2			μs
t _{HOLD}	Sampling capacitor hold time			25	ns
t _{pd1}	$\overline{\text{CONVST}}$ low to conversion started (BUSY high)			50	ns
t _{pd2}	Propagation delay time, end of conversion to BUSY low			25	ns
t _{pd3}	Propagation delay time, from start of conversion (internal state) to rising edge of BUSY			25	ns
t _{w1}	Pulse duration, $\overline{\text{CONVST}}$ low	40		400	ns
t _{su1}	Setup time, $\overline{\text{CS}}$ low to $\overline{\text{CONVST}}$ low	20			ns
t _{w2}	Pulse duration, $\overline{\text{CONVST}}$ high	20			ns
	$\overline{\text{CONVST}}$ falling edge jitter			10	ps
t _{w3}	Pulse duration, BUSY signal low	Min(t _{ACQ})			μs
t _{w4}	Pulse duration, BUSY signal high			1.13	μs
t _{h1}	Hold time, first data bus transition ($\overline{\text{CS}}$ low for read cycle, or $\overline{\text{RD}}$ or BYTE input changes) after $\overline{\text{CONVST}}$ low	40		400	ns
t _{d1}	Delay time, $\overline{\text{CS}}$ low to $\overline{\text{RD}}$ low	0			ns
t _{su2}	Setup time, $\overline{\text{RD}}$ high to $\overline{\text{CS}}$ high	0			ns
t _{w5}	Pulse duration, $\overline{\text{RD}}$ low	50			ns
t _{en}	Enable time, $\overline{\text{RD}}$ low (or $\overline{\text{CS}}$ low for read cycle) to data valid			30	ns
t _{d2}	Delay time, data hold from $\overline{\text{RD}}$ high	10			ns
t _{d3}	Delay time, BUS18/16 or BYTE rising edge or falling edge to data valid	10		30	ns
t _{w6}	Pulse duration, $\overline{\text{RD}}$ high time	20			ns
t _{w7}	Pulse duration, $\overline{\text{CS}}$ high time	20			ns
t _{h2}	Hold time, last $\overline{\text{CS}}$ rising edge or changes of $\overline{\text{RD}}$, or BYTE to $\overline{\text{CONVST}}$ falling edge	125			ns
t _{pd4}	Propagation delay time, BUSY falling edge to next $\overline{\text{RD}}$ (or $\overline{\text{CS}}$ for read cycle) falling edge	Max(td5)			ns
t _{su3}	Setup time, BYTE transition to $\overline{\text{RD}}$ falling edge	10			ns
t _{h3}	Hold time, BYTE transition to $\overline{\text{RD}}$ falling edge	10			ns
t _{dis}	Disable time, $\overline{\text{RD}}$ High ($\overline{\text{CS}}$ high for read cycle) to 3-stated data bus			30	ns
t _{d5}	Delay time, BUSY low to MSB data valid delay time			40	ns
t _{su5}	Setup time, BYTE transition to next BYTE transition	50			ns
t _{su(AB)}	Setup time, from the falling edge of $\overline{\text{CONVST}}$ (used to start the valid conversion) to the next falling edge of $\overline{\text{CONVST}}$ (when $\overline{\text{CS}} = 0$ and $\overline{\text{CONVST}}$ used to abort) or to the next falling edge of $\overline{\text{CS}}$ (when $\overline{\text{CS}}$ is used to abort).	70		700	ns
t _{f(CONVST)}	Falling time, ($\overline{\text{CONVST}}$ falling edge)	10		30	ns
t _{su6}	Setup time, $\overline{\text{CS}}$ falling edge to $\overline{\text{CONVST}}$ falling edge when $\overline{\text{RD}} = 0$	125			ns

(1) All input signals are specified with $t_r = t_f = 5\text{ ns}$ (10% to 90% of $+V_{BD}$) and timed from a voltage level of $(V_{IL} + V_{IH})/2$ except for $\overline{\text{CONVST}}$.

(2) See timing diagrams.

(3) All timing are measured with 10 pF equivalent loads on all data bits and BUSY pins.

ADS8371

SLAS390A – JUNE 2003 – REVISED DECEMBER 2003

PIN ASSIGNMENTS

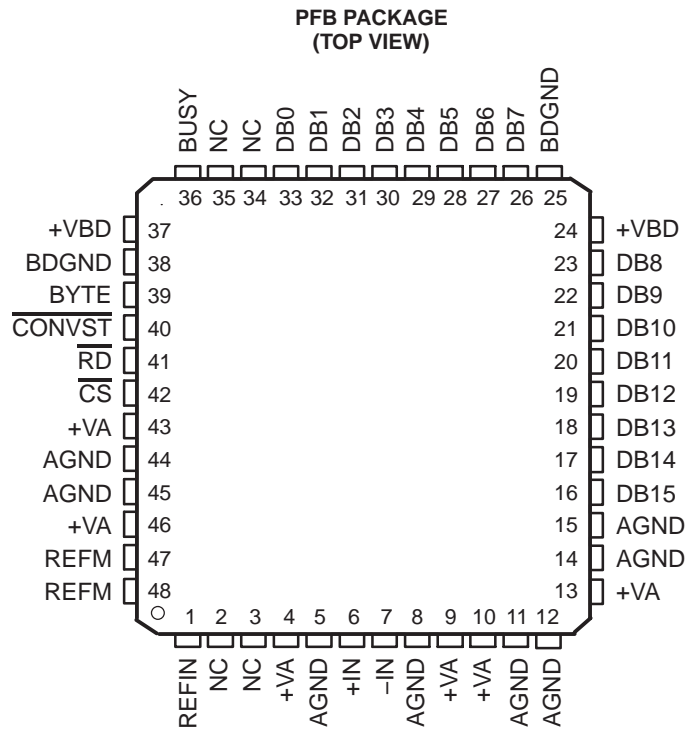

NC – No connection.

TERMINAL FUNCTIONS

NAME	NO.	I/O	DESCRIPTION		
AGND	5, 8, 11, 12, 14, 15, 44, 45	–	Analog ground		
BDGND	25, 38	–	Digital ground for buffer supply		
BUSY	36	O	Status output. High when a conversion is in progress.		
BYTE	39	I	Byte select input. Used for 8-bit bus reading. 0: No fold back 1: Low byte D[7:0] of the 16 most significant bits is folded back to high byte of the 16 most significant pins DB[15:8].		
$\overline{\text{CONVST}}$	40	I	Convert start. The falling edge of this input ends the acquisition period and starts the hold period.		
$\overline{\text{CS}}$	42	I	Chip select. The falling edge of this input starts the acquisition period.		
Data Bus			8-Bit Bus		16-Bit Bus
			BYTE = 0	BYTE = 1	BYTE = 0
DB15	16	O	D15 (MSB)	D7	D15 (MSB)
DB14	17	O	D14	D6	D14
DB13	18	O	D13	D5	D13
DB12	19	O	D12	D4	D12
DB11	20	O	D11	D3	D11
DB10	21	O	D10	D2	D10
DB9	22	O	D9	D1	D9
DB8	23	O	D8	D0 (LSB)	D8
DB7	26	O	D7	All ones	D7
DB6	27	O	D6	All ones	D6
DB5	28	O	D5	All ones	D5
DB4	29	O	D4	All ones	D4
DB3	30	O	D3	All ones	D3
DB2	31	O	D2	All ones	D2
DB1	32	O	D1	All ones	D1
DB0	33	O	D0 (LSB)	All ones	D0 (LSB)
–IN	7	I	Inverting input channel		
+IN	6	I	Non inverting input channel		
NC	2, 3, 34, 35	–	No connection		
REFIN	1	I	Reference input		
REFM	47, 48	I	Reference ground		
$\overline{\text{RD}}$	41	I	Synchronization pulse for the parallel output. When $\overline{\text{CS}}$ is low, this serves as the output enable and puts the previous conversion result on the bus.		
+VA	4, 9, 10, 13, 43, 46	–	Analog power supplies, 5-V dc		
+VBD	24, 37	–	Digital power supply for the buffer		

ADS8371

SLAS390A – JUNE 2003 – REVISED DECEMBER 2003

TIMING DIAGRAMS

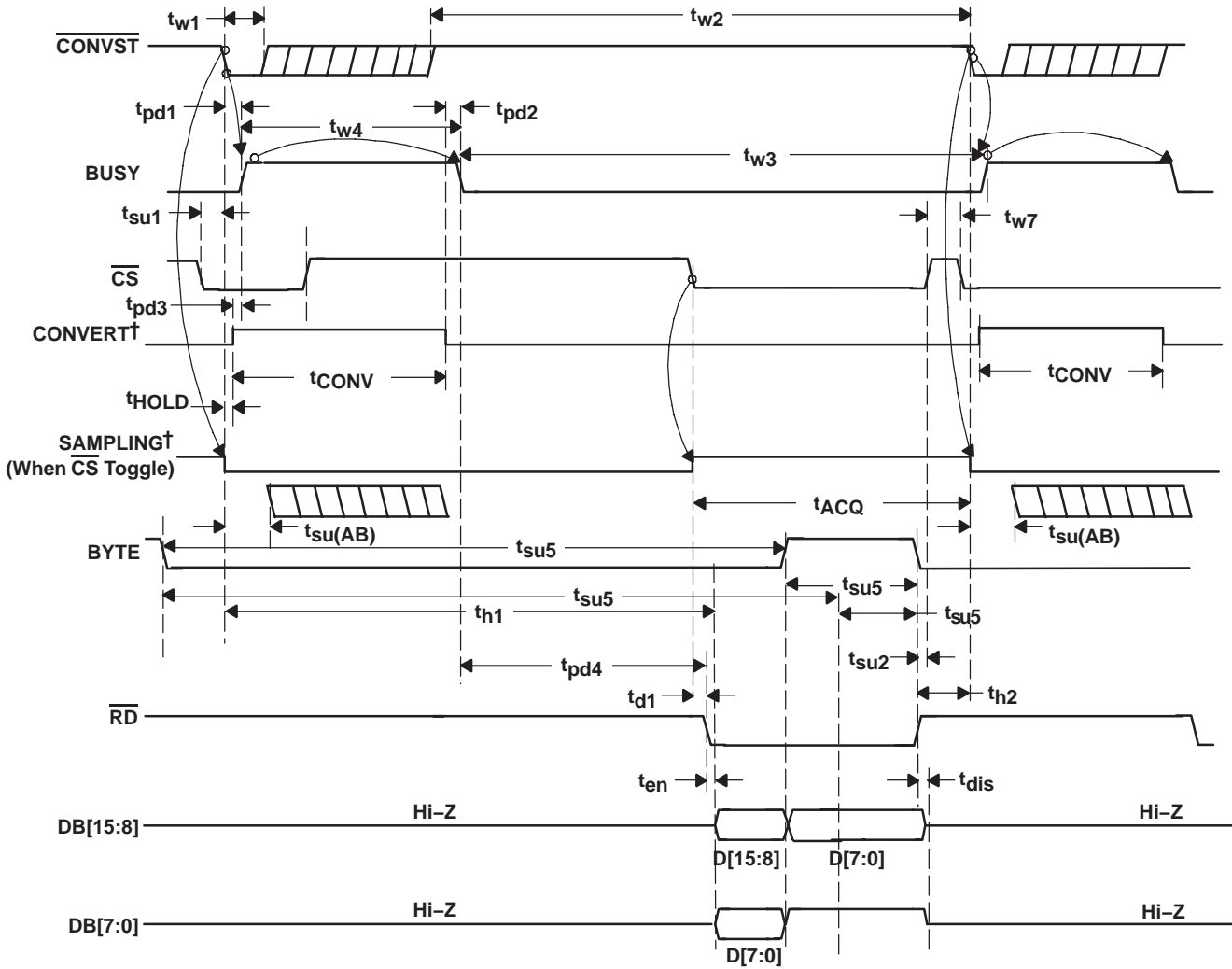

† Signal internal to device

Figure 1. Timing for Conversion and Acquisition Cycles With $\overline{\text{CS}}$ and $\overline{\text{RD}}$ Toggling

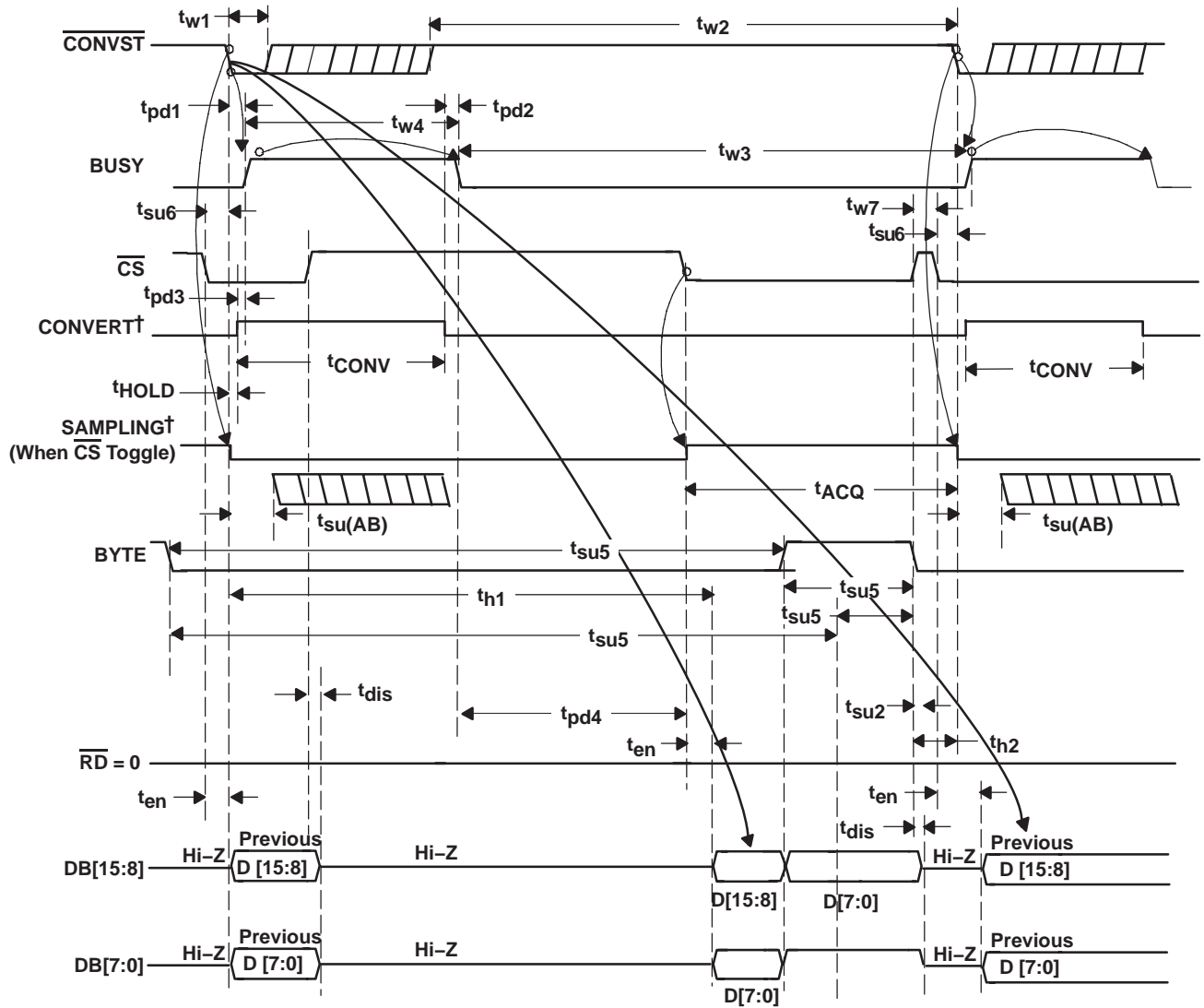

†Signal internal to device

Figure 2. Timing for Conversion and Acquisition Cycles With \overline{CS} Toggling, \overline{RD} Tied to BDGND

ADS8371

SLAS390A – JUNE 2003 – REVISED DECEMBER 2003

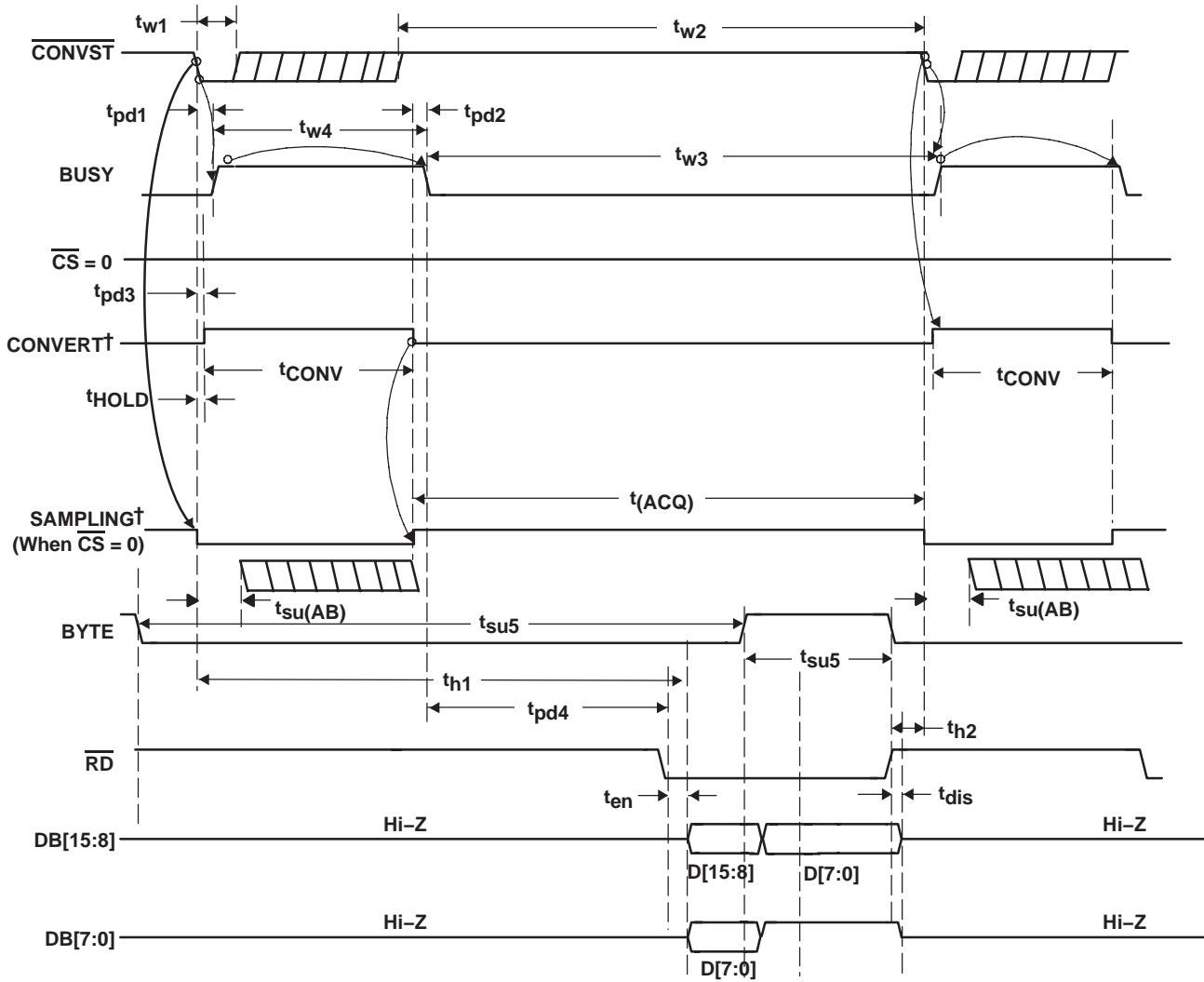

†Signal internal to device

Figure 3. Timing for Conversion and Acquisition Cycles With \overline{CS} Tied to BDGND, \overline{RD} Toggling

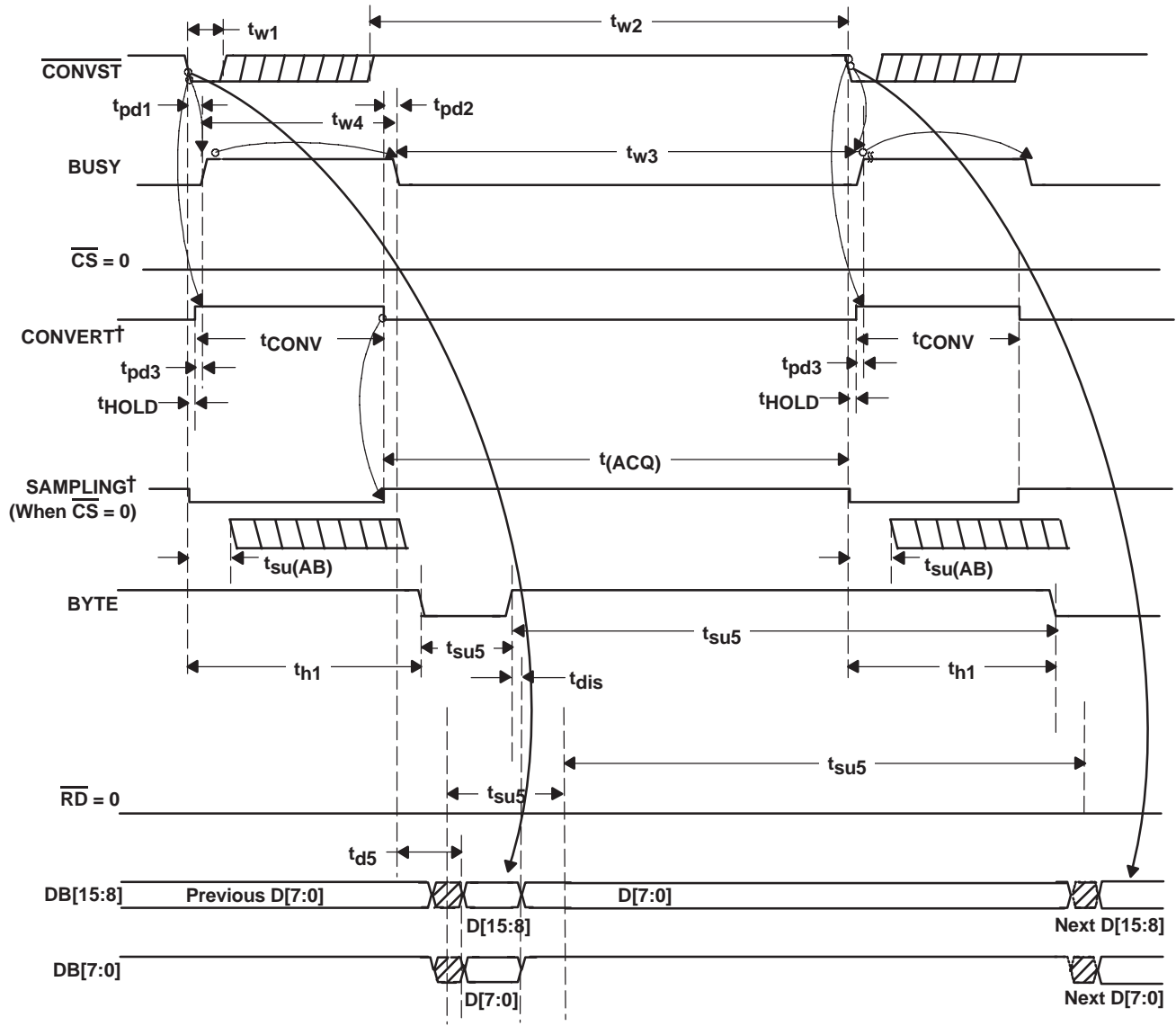

†Signal internal to device

Figure 4. Timing for Conversion and Acquisition Cycles With \overline{CS} and \overline{RD} Tied to BDGND—Auto Read

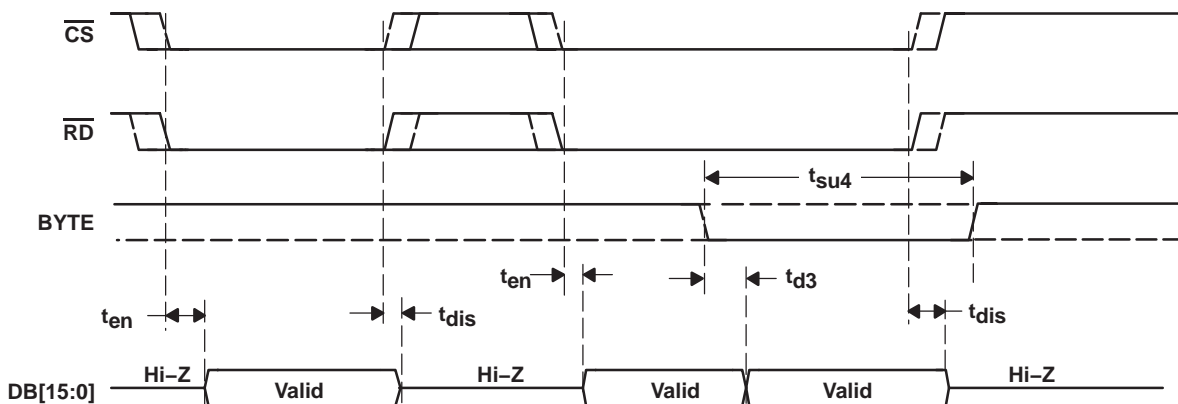

Figure 5. Detailed Timing for Read Cycles

TYPICAL CHARACTERISTICS(1)

HISTOGRAM (DC CODE SPREAD)
HALF SCALE 4096 CONVERSIONS

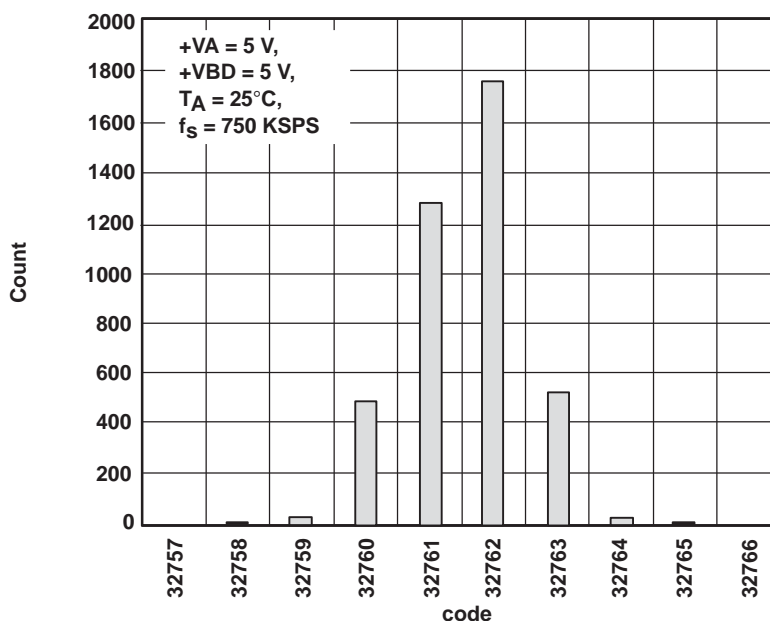

Figure 6

GAIN ERROR
vs
FREE-AIR TEMPERATURE

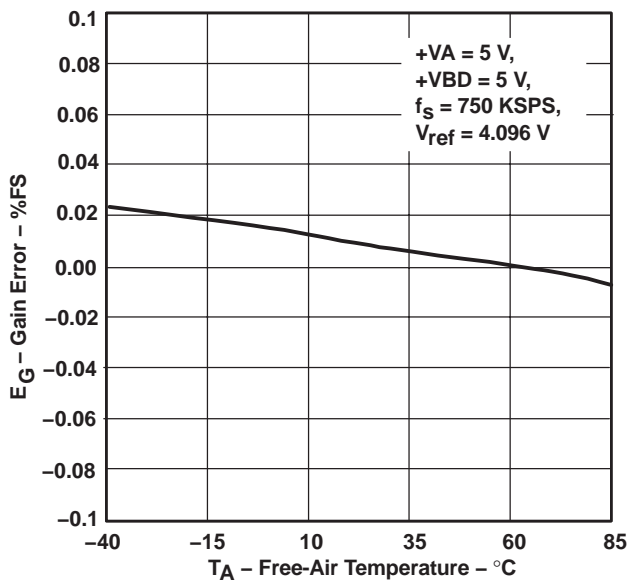

Figure 7

GAIN ERROR
vs
FREE-AIR TEMPERATURE

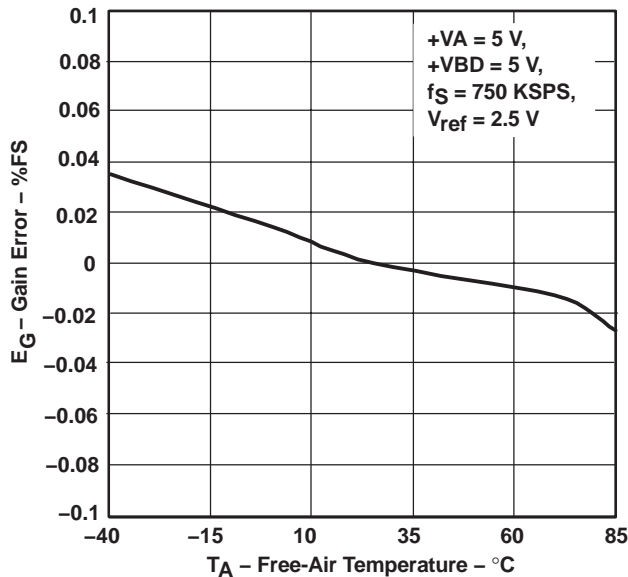

Figure 8

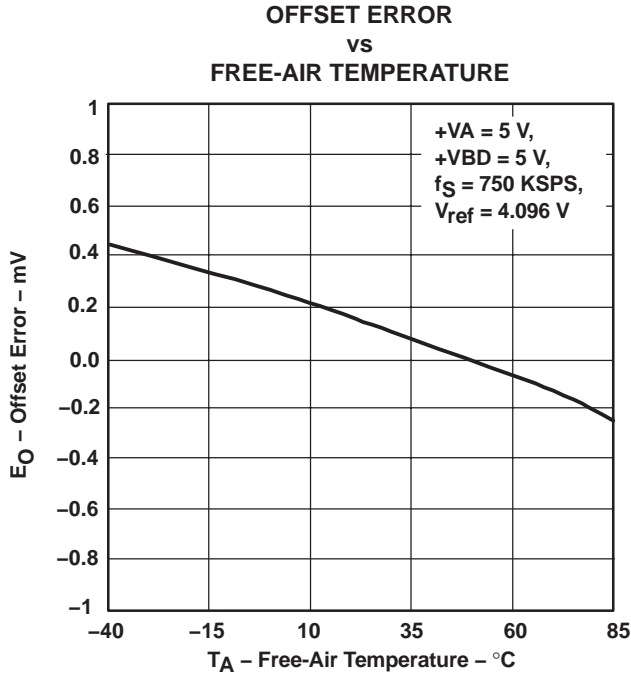

Figure 9

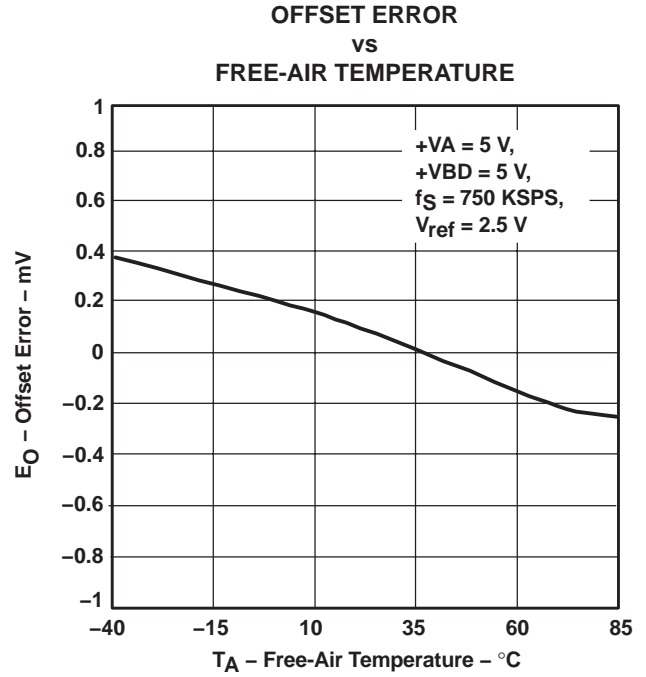

Figure 10

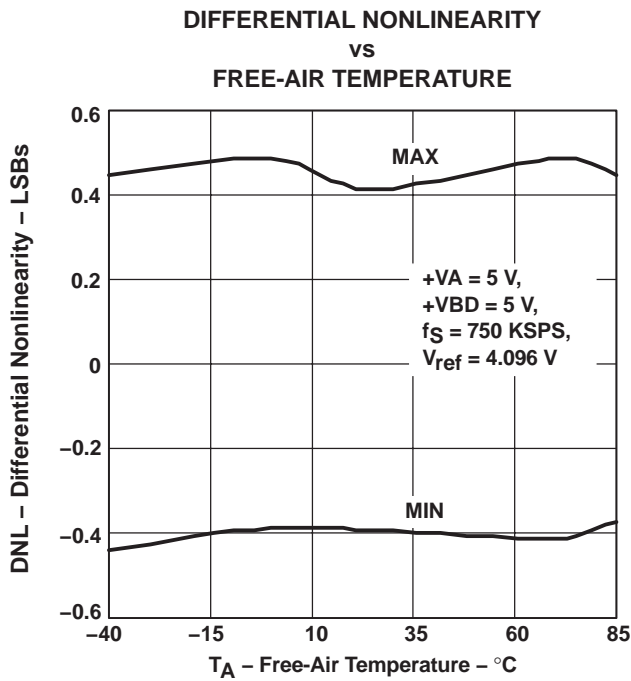

Figure 11

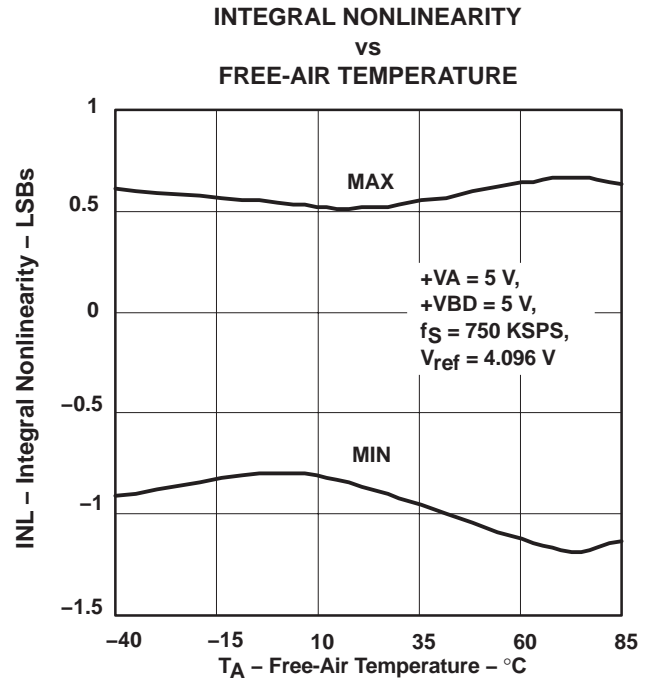

Figure 12

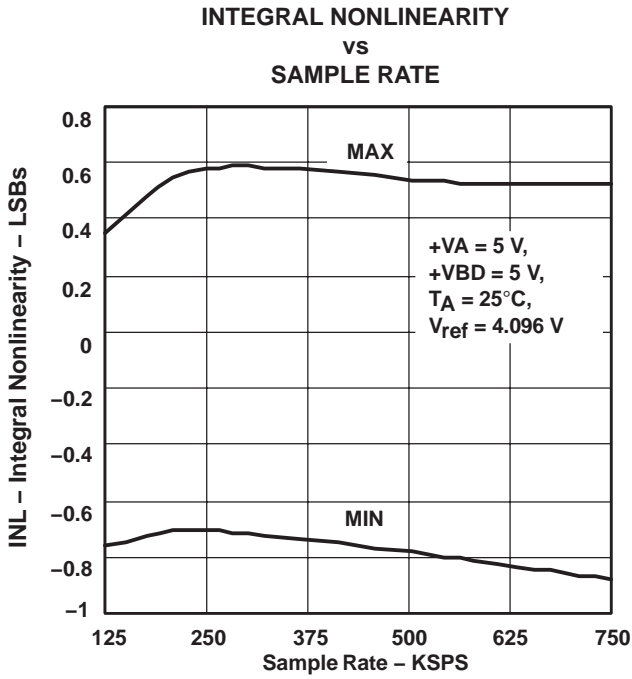

Figure 13

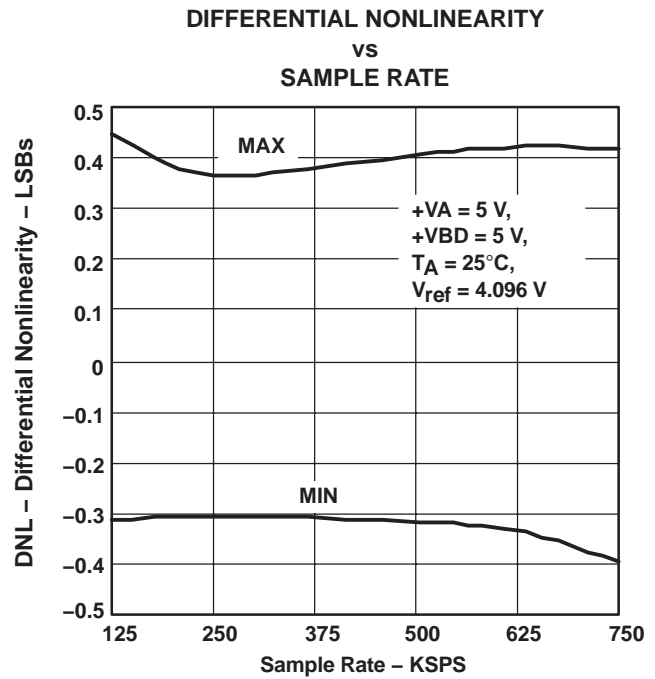

Figure 14

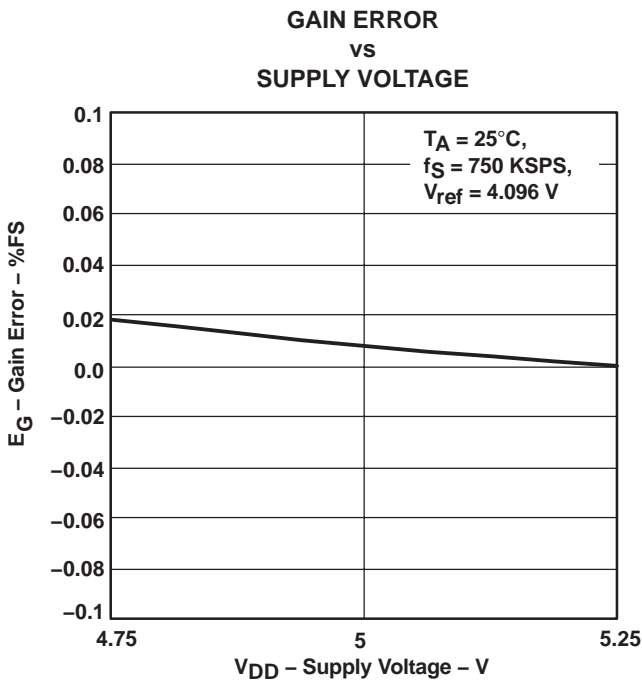

Figure 15

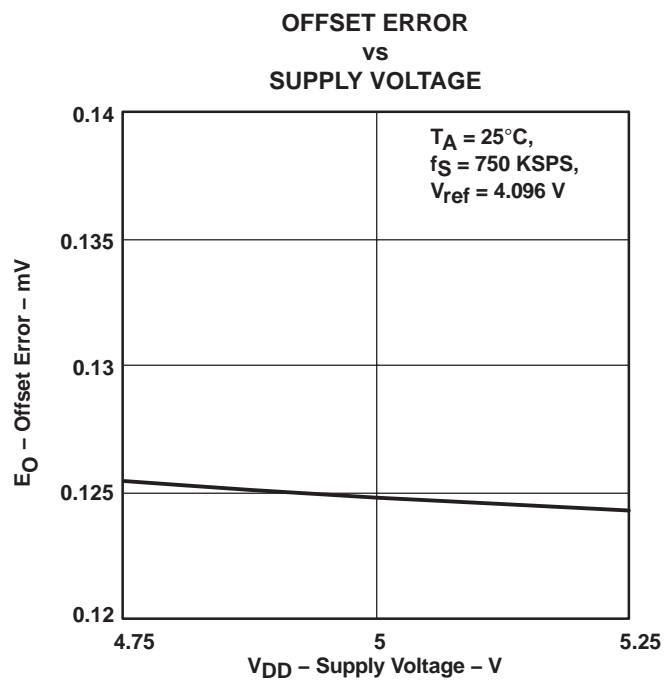
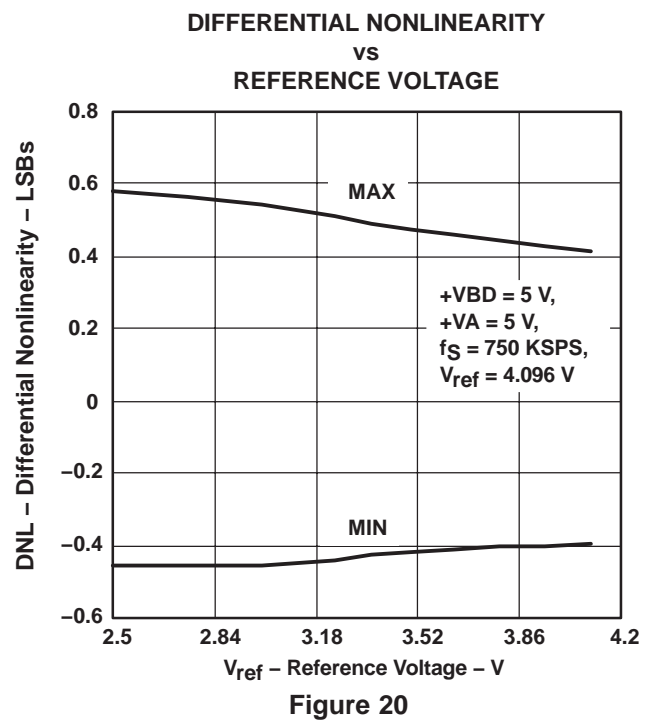
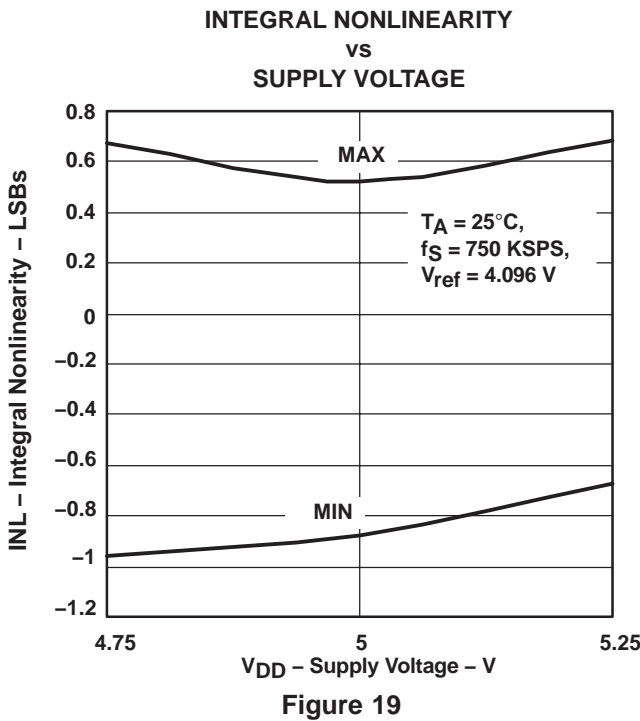
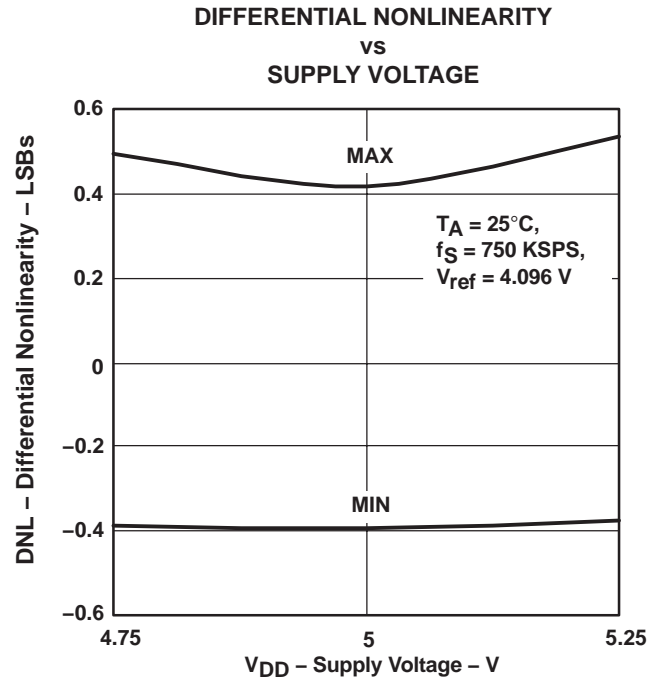
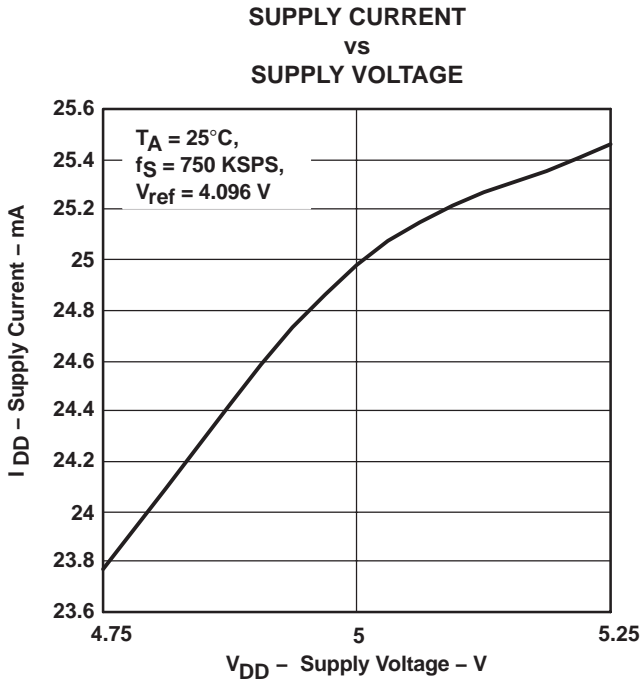

Figure 16



INTEGRAL NONLINEARITY
vs
REFERENCE VOLTAGE

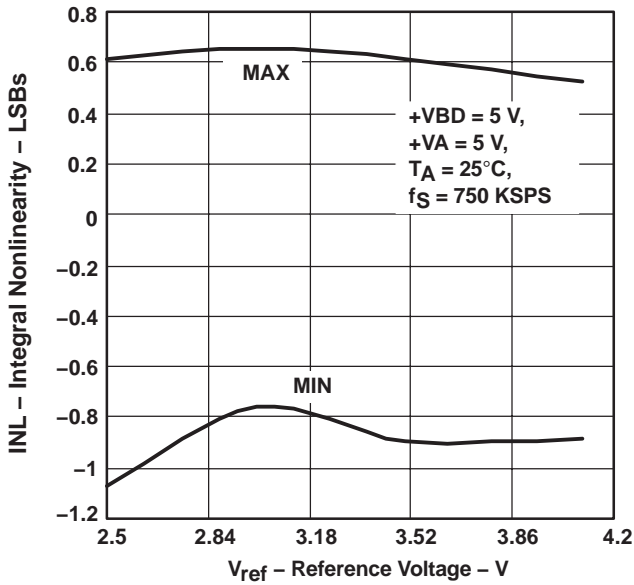

Figure 21

OFFSET ERROR
vs
REFERENCE VOLTAGE

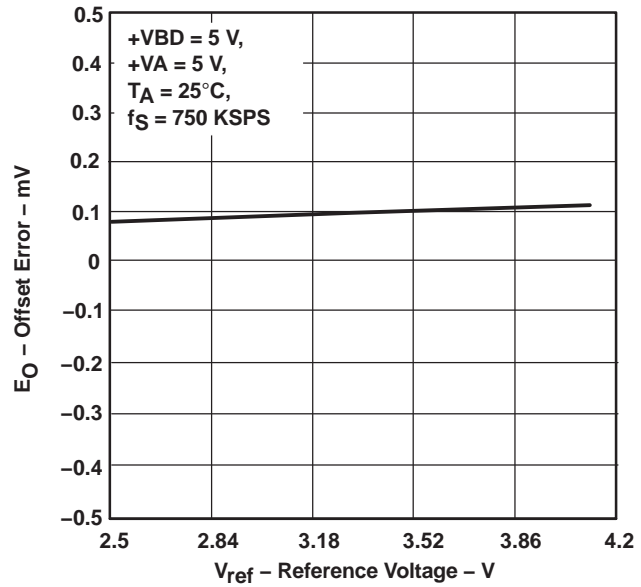

Figure 22

SIGNAL-TO-NOISE RATIO
vs
FREE-AIR TEMPERATURE

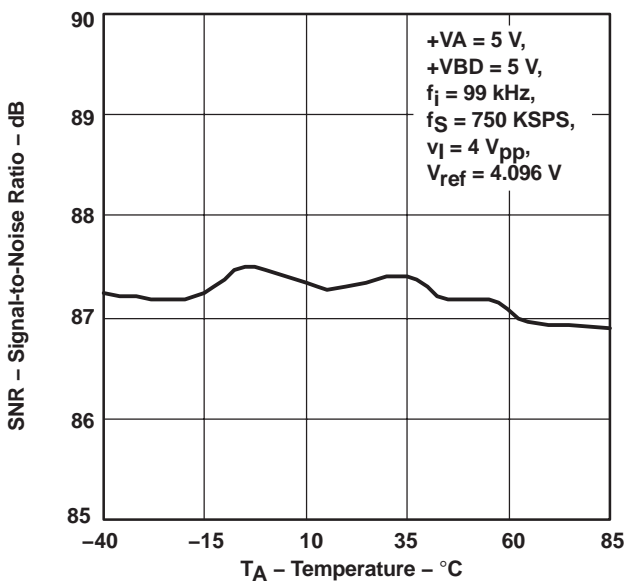

Figure 23

TOTAL HARMONIC DISTORTION
vs
FREE-AIR TEMPERATURE

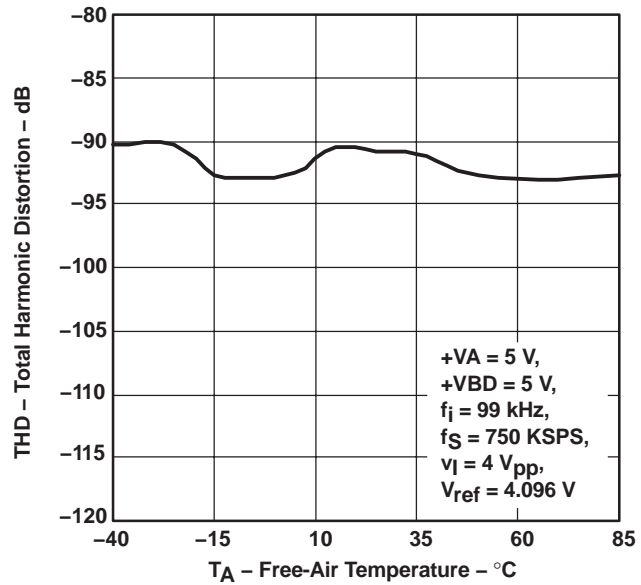

Figure 24

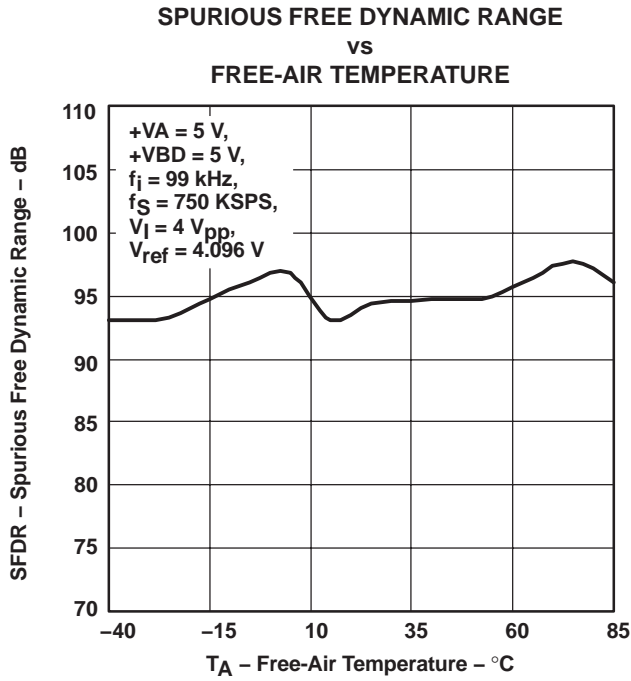

Figure 25

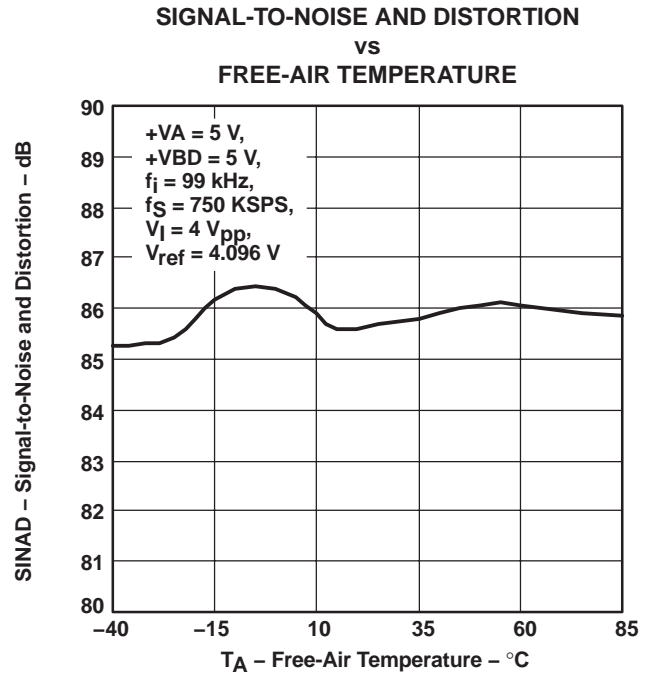

Figure 26

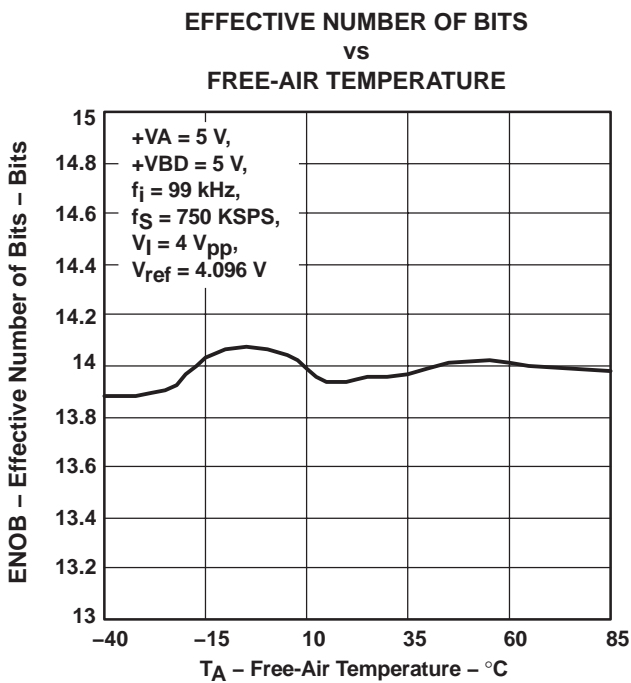

Figure 27

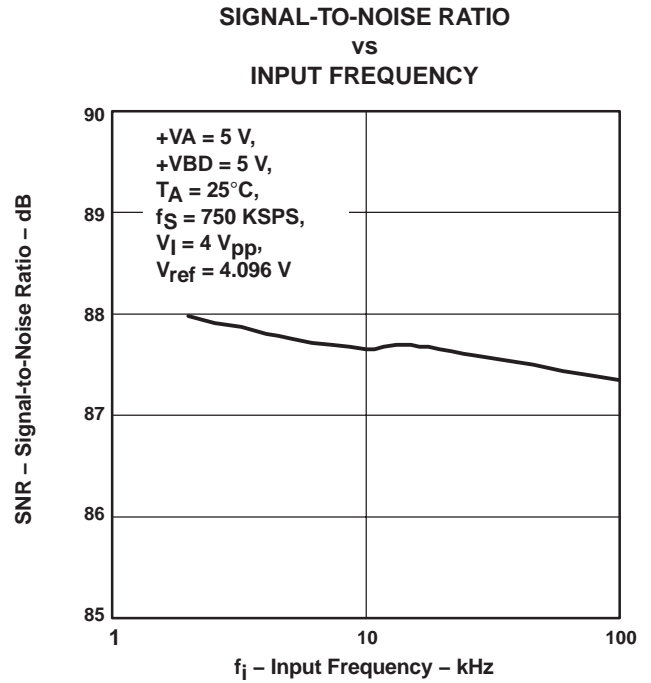

Figure 28

**TOTAL HARMONIC DISTORTION
vs
INPUT FREQUENCY**

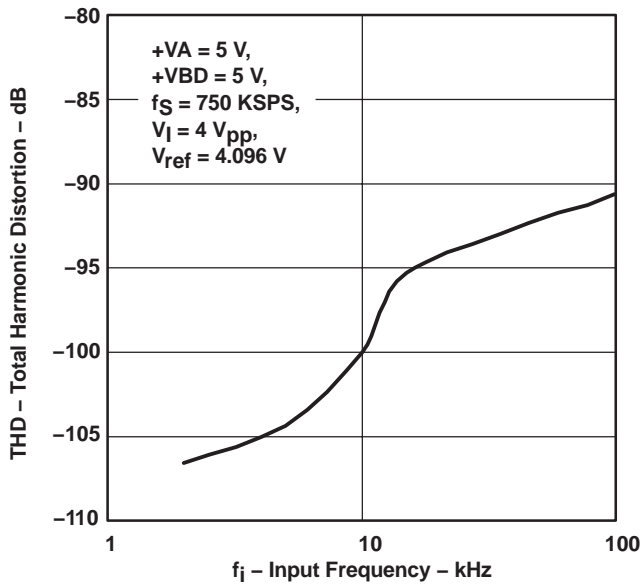

Figure 29

**SIGNAL-TO-NOISE AND DISTORTION
vs
INPUT FREQUENCY**

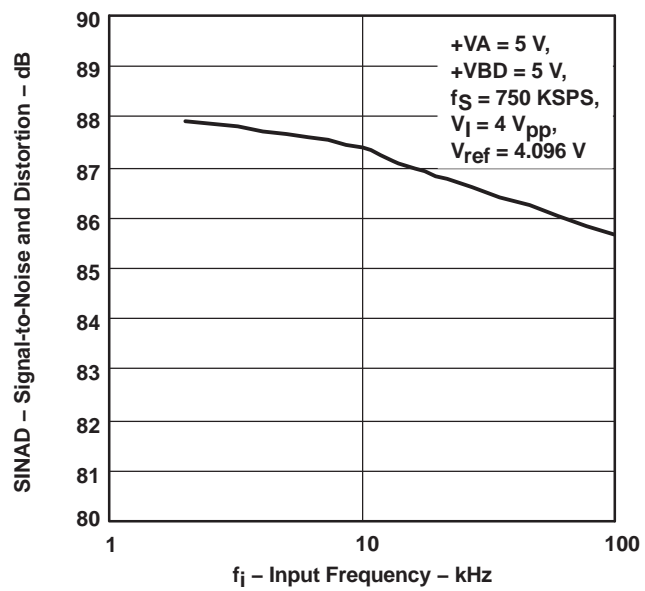

Figure 30

**EFFECTIVE NUMBER OF BITS
vs
INPUT FREQUENCY**

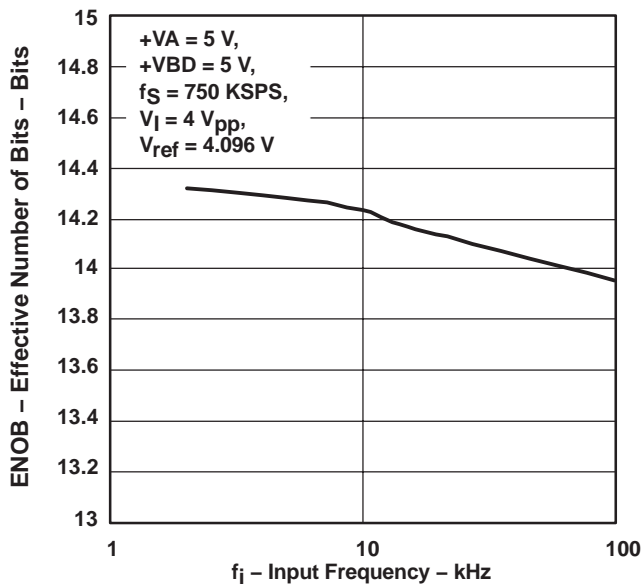

Figure 31

**SPURIOUS FREE DYNAMIC RANGE
vs
INPUT FREQUENCY**

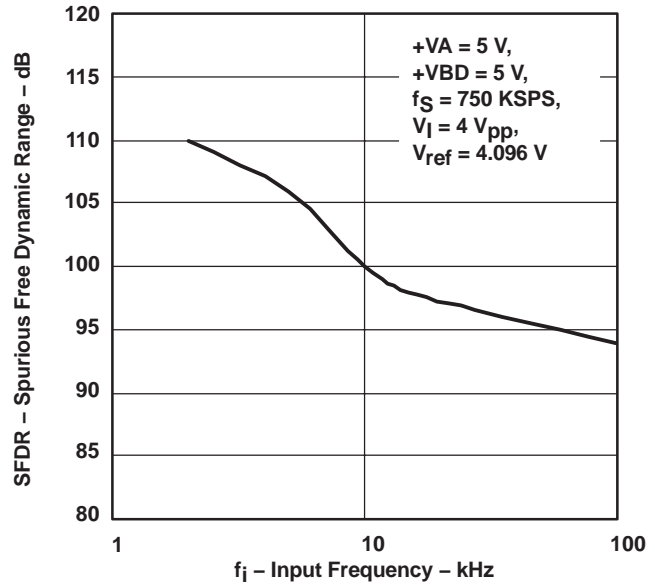
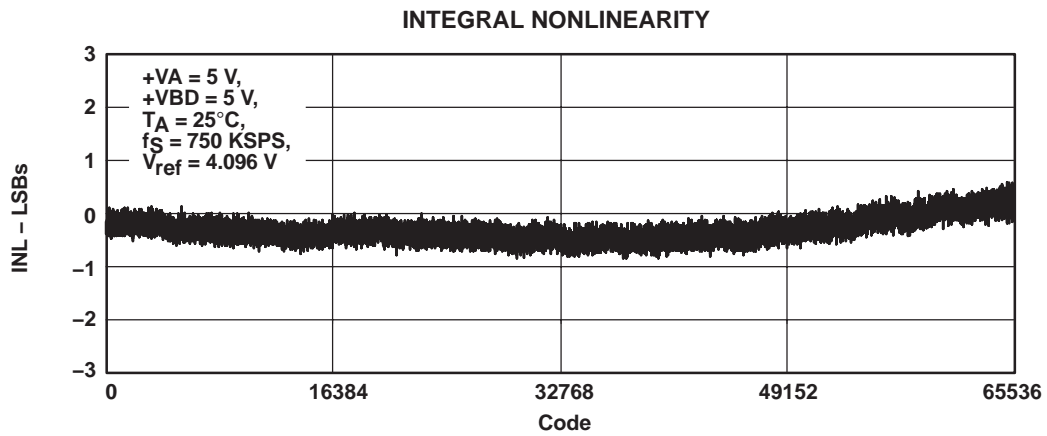
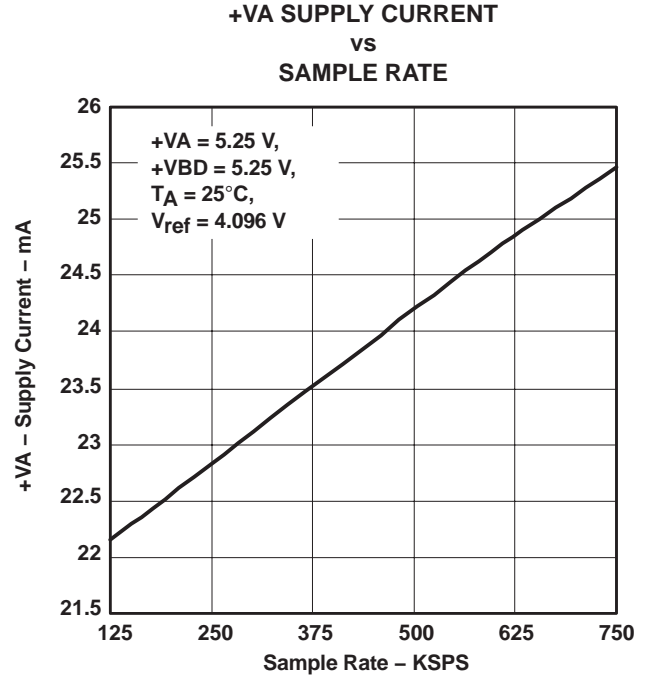
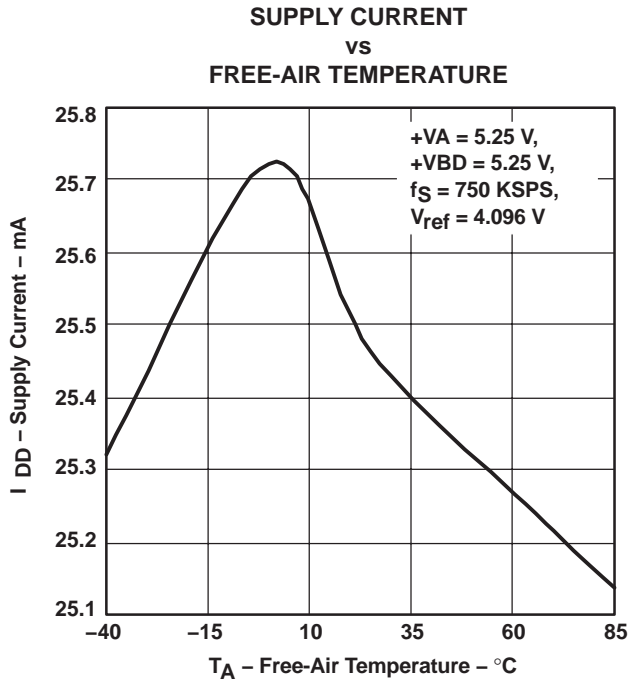

Figure 32



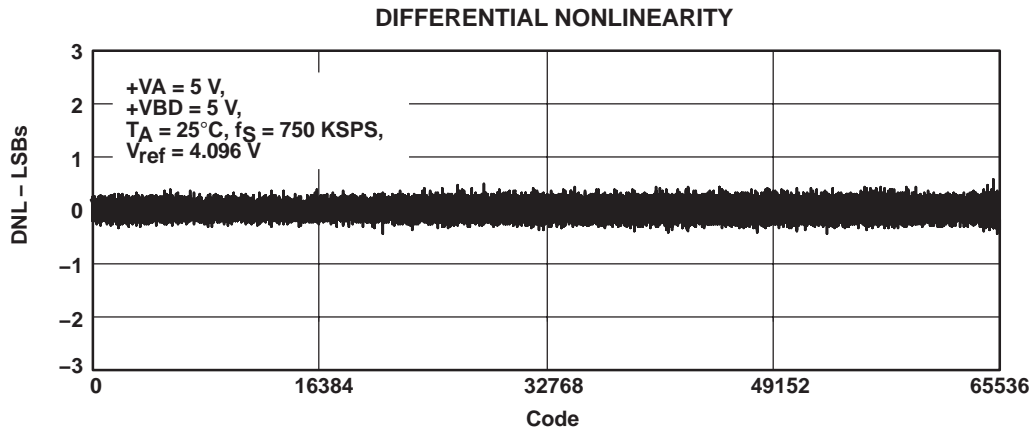

Figure 36

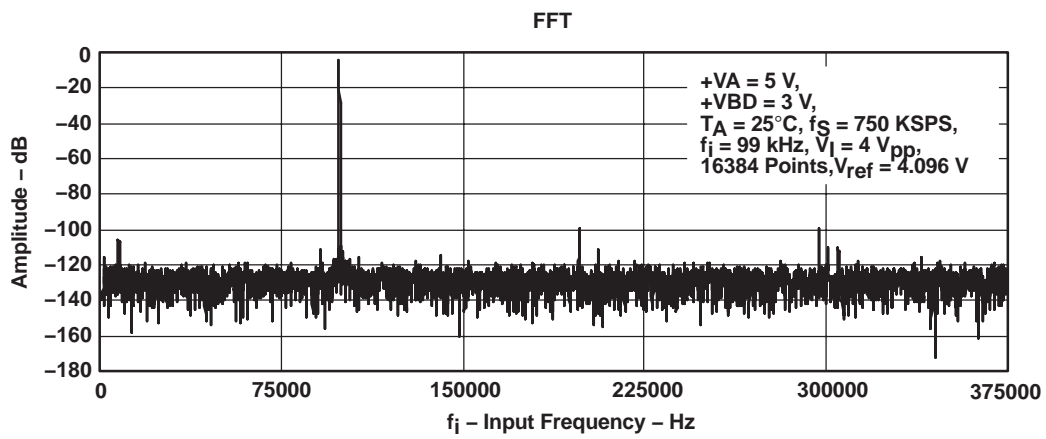

Figure 37

APPLICATION INFORMATION

MICROCONTROLLER INTERFACING

ADS8371 to 8-Bit Microcontroller Interface

Figure 38 shows a parallel interface between the ADS8371 and a typical microcontroller using the 8-bit data bus. The BUSY signal is used as a falling-edge interrupt to the microcontroller.

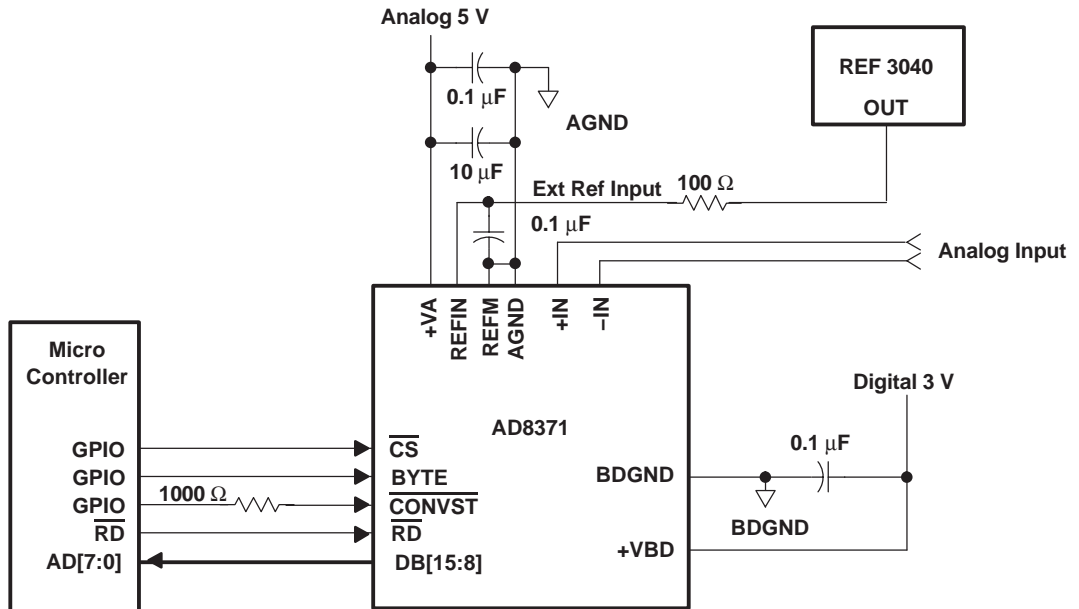

Figure 38. ADS8371 Application Circuitry

PRINCIPLES OF OPERATION

The ADS8371 is a high-speed successive approximation register (SAR) analog-to-digital converter (ADC). The architecture is based on charge redistribution which inherently includes a sample/hold function. See Figure 38 for the application circuit for the ADS8371.

The conversion clock is generated internally. The conversion time of 1.13 μs is capable of sustaining a 750-kHz throughput.

The analog input is provided to two input pins: +IN and –IN. When a conversion is initiated, the differential input on these pins is sampled on the internal capacitor array. While a conversion is in progress, both inputs are disconnected from any internal function.

REFERENCE

The ADS8371 can operate with an external reference with a range from 2.5 V to 4.2 V. The reference voltage on the input pin 1 (REFIN) of the converter is internally buffered. A clean, low noise, well-decoupled reference voltage on this pin is required to ensure good performance of the converter. A low noise band-gap reference like the REF3040 can be used to drive this pin. A 0.1- μF decoupling capacitor is required between pin 1 and pin 48 of the converter. This capacitor should be placed as close as possible to the pins of the device. Designers should strive to minimize the routing length of the traces that connect the terminals of the capacitor to the pins of the converter. An RC network can also be used to filter the reference voltage. A 100- Ω series resistor and a 0.1- μF capacitor, which can also serve as the decoupling capacitor, can be used to filter the reference voltage.

ANALOG INPUT

When the converter enters the hold mode, the voltage difference between the +IN and –IN inputs is captured on the internal capacitor array. The voltage on the –IN input is limited between -0.2 V and 0.2 V , allowing the input to reject small signals which are common to both the +IN and –IN inputs. The +IN input has a range of -0.2 V to $V_{\text{ref}} + 0.2\text{ V}$. The input span (+IN – (–IN)) is limited to 0 V to V_{ref} .

The input current on the analog inputs depends upon a number of factors: sample rate, input voltage, and source impedance. Essentially, the current into the ADS8371 charges the internal capacitor array during the sample period. After this capacitance has been fully charged, there is no further input current. The source of the analog input voltage must be able to charge the input capacitance (45 pF) to an 16-bit settling level within the acquisition time (200 ns) of the device. When the converter goes into the hold mode, the input impedance is greater than 1 G Ω .

Care must be taken regarding the absolute analog input voltage. To maintain the linearity of the converter, the +IN and –IN inputs and the span (+IN – (–IN)) should be within the limits specified. Outside of these ranges, the converter's linearity may not meet specifications. To minimize noise, low bandwidth input signals with low-pass filters should be used.

Care should be taken to ensure that the output impedance of the sources driving the +IN and –IN inputs are matched. If this is not observed, the two inputs could have different settling times. This may result in offset error, gain error, and linearity error which changes with temperature and input voltage.

The analog input to the converter needs to be driven with a low noise, high-speed op-amp like the THS4031. An RC filter is recommended at the input pins to low-pass filter the noise from the source. A series resistor of 15 Ω and a decoupling capacitor of 200 pF is recommended.

The input to the converter is a unipolar input voltage in the range 0 V to V_{ref} . The THS4031 can be used in the source follower configuration to drive the converter.

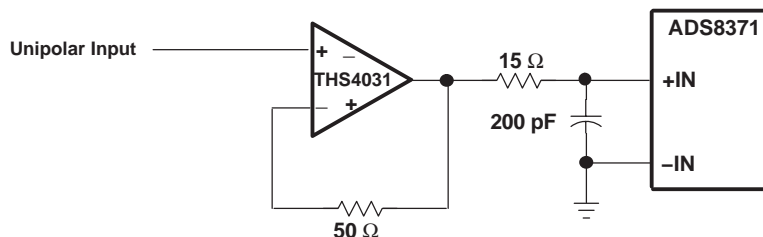

Figure 39. Unipolar Input to Converter

In systems where the input is bipolar, the THS4031 can be used in the inverting configuration with an additional DC bias applied to its + input so as to keep the input to the ADS8371 within its rated operating voltage range. This configuration is also recommended when the ADS8371 is used in signal processing applications where good SNR and THD performance is required. The DC bias can be derived from the REF3020 or the REF3040 reference voltage ICs. The input configuration shown below is capable of delivering better than 87-dB SNR and –90-dB THD at an input frequency of 100 kHz. In case bandpass filters are used to filter the input, care should be taken to ensure that the signal swing at the input of the bandpass filter is small so as to keep the distortion introduced by the filter minimal. In such cases, the gain of the circuit shown in Figure 40 can be increased to keep the input to the ADS8371 large to keep the SNR of the system high. Note that the gain of the system from the + input to the output of the THS4031 in such a configuration is a function of the gain of the AC signal. A resistor divider can be used to scale the output of the REF3020 or REF3040 to reduce the voltage at the DC input to THS4031 to keep the voltage at the input of the converter within its rated operating range.

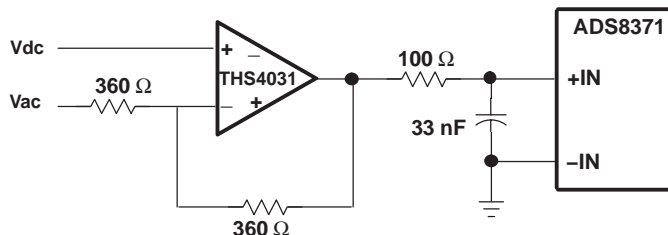

Figure 40. Bipolar Input to Converter

DIGITAL INTERFACE

Timing And Control

See the timing diagrams in the specifications section for detailed information on timing signals and their requirements.

The ADS8371 uses an internal oscillator generated clock which controls the conversion rate and in turn the throughput of the converter. No external clock input is required.

Conversions are initiated by bringing the $\overline{\text{CONVST}}$ pin low for a minimum of 40 ns (after the 40 ns minimum requirement has been met, the $\overline{\text{CONVST}}$ pin can be brought high), while $\overline{\text{CS}}$ is low. The BUSY output is brought high immediately following $\overline{\text{CONVST}}$ going low. BUSY stays high throughout the conversion process and returns low when the conversion has ended. Sampling starts with the falling edge of the BUSY signal when $\overline{\text{CS}}$ is tied low or starts with the falling edge of $\overline{\text{CS}}$ when BUSY is low.

Both $\overline{\text{RD}}$ and $\overline{\text{CS}}$ can be high during and before a conversion with one exception ($\overline{\text{CS}}$ must be low when $\overline{\text{CONVST}}$ goes low to initiate a conversion). Both the RD and CS pins are brought low in order to enable the parallel output bus with the conversion.

ADS8371

SLAS390A – JUNE 2003 – REVISED DECEMBER 2003

Digital Inputs

The converter switches from sample to hold mode at the falling edge of the $\overline{\text{CONVST}}$ input pin. A clean and low jitter falling edge is important to the performance of the converter. A sharp falling transition on this pin can affect the voltage that is acquired by the converter. A falling transition time in the range of 10 ns to 30 ns is required to achieve the rated performance of the converter. A resistor of approximately 1000 Ω (10% tolerance) can be placed in series with the $\overline{\text{CONVST}}$ input pin to satisfy this requirement.

The other digital inputs to the ADS8371 do not require any resistors in series with them. However, certain precautions are necessary to ensure that transitions on these inputs do not affect converter performance. It is recommended that all activity on the input pins happen during the first 400 ns of the conversion period. This allows the error correction circuits inside the device to correct for any errors that these activities cause on the converter output. For example, when the converter is operated with $\overline{\text{CS}}$ and $\overline{\text{RD}}$ tied to ground, the signal $\overline{\text{CONVST}}$ can be brought low to initiate a conversion and brought high after a duration not exceeding 400 ns. Figure 41 shows the recommended timing for the $\overline{\text{CONVST}}$ input with $\overline{\text{RD}}$ and $\overline{\text{CS}}$ tied low.

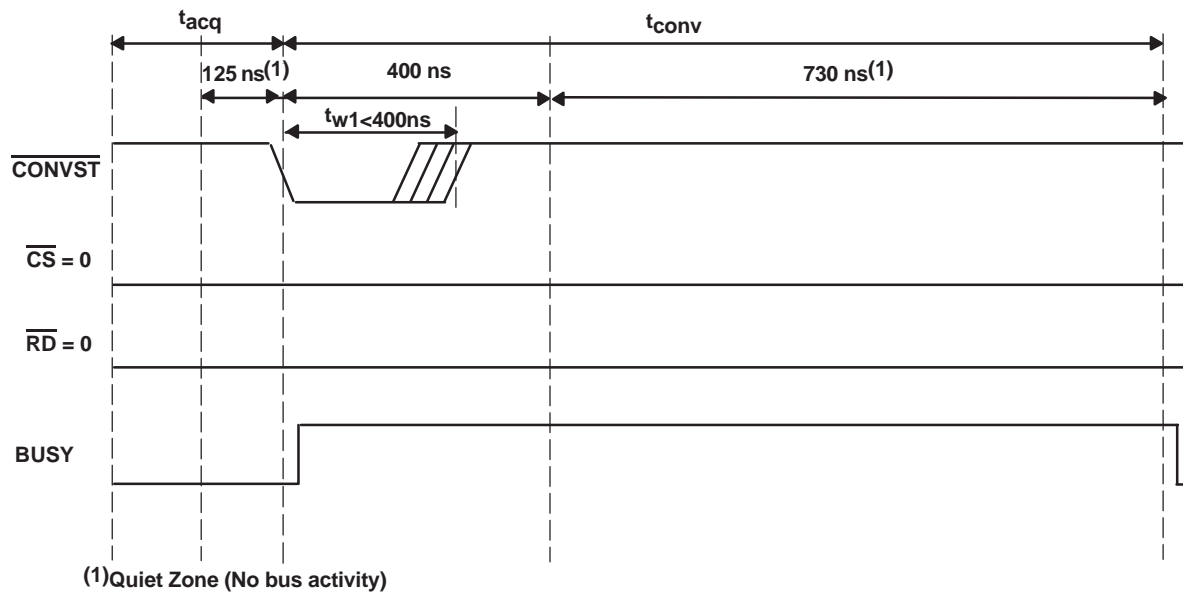

Figure 41. Timing for $\overline{\text{CONVST}}$ When $\overline{\text{CS}} = \overline{\text{RD}} = \text{BDGND}$

A similar precaution applies when \overline{RD} is used to three-state the output buffers after a data-read operation. A minimum quiet period of 125 ns is also required from the instant the data is changed on the bus (such as the falling or rising edge of \overline{RD} , the falling or rising edge of \overline{BYTE} , and the falling is made available on the data bus pins to the sampling instant (falling edge of \overline{CONVST}). Figure 42 shows the timing of the input control signals that allow these conditions to be satisfied.

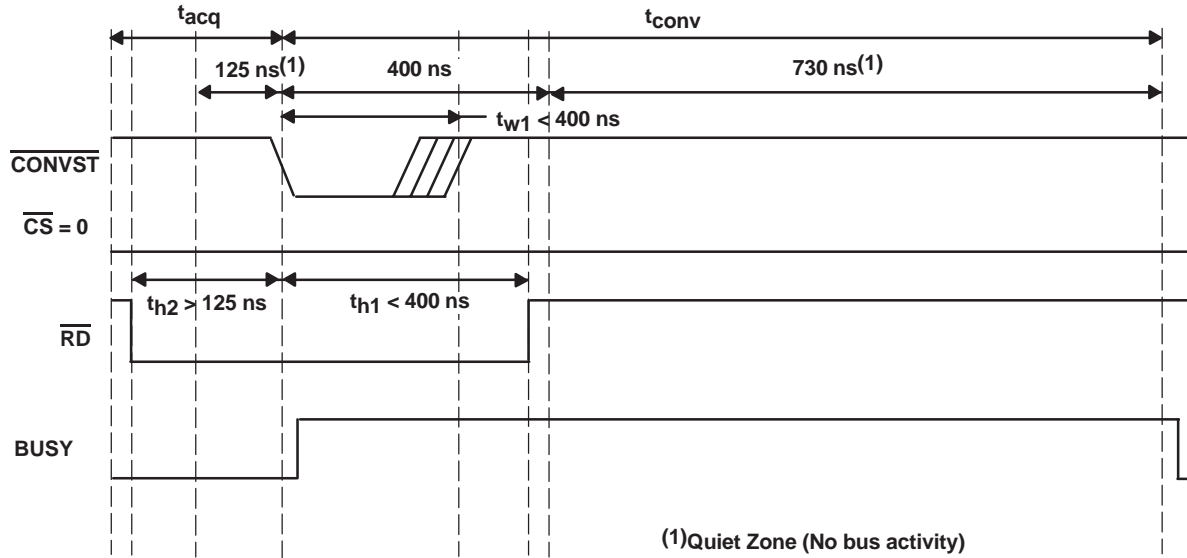

Figure 42. Bus Activity Split to Avoid Quiet Zone

ADS8371

SLAS390A – JUNE 2003 – REVISED DECEMBER 2003

If the \overline{RD} pin is brought high to three-state the data buses, the three-stating operation should occur 125 ns before the end of the acquisition phase. Figure 43 shows the recommended timing for using the ADS8381 in this mode of operation. The same principle applies to other bus activities such as BYTE.

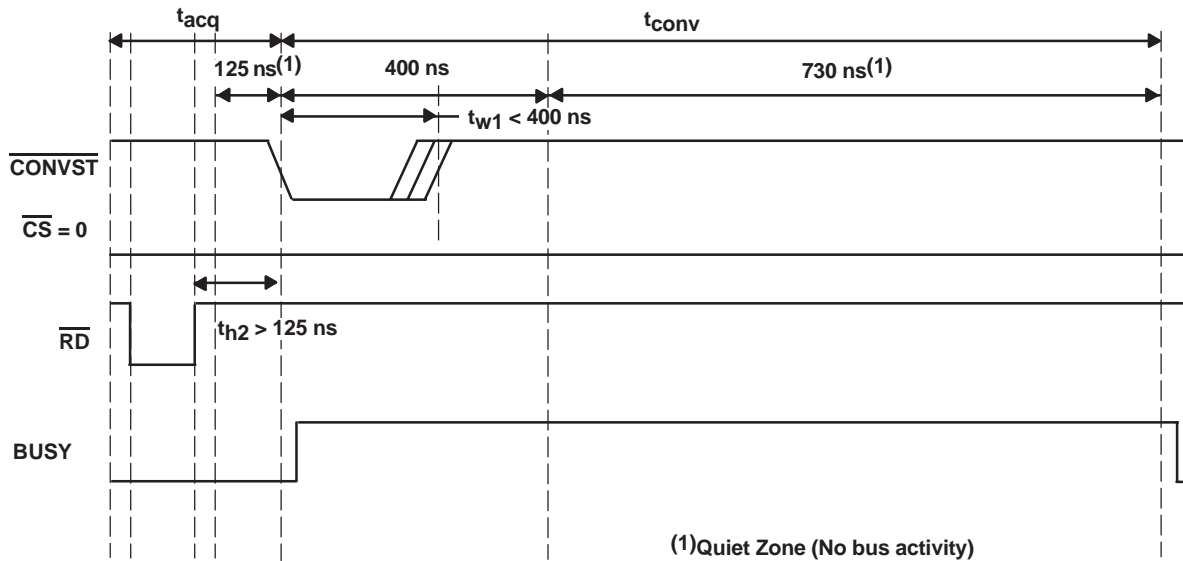

Figure 43. Read Timing if the Bus Needs to be Three-Stated

Reading Data

The ADS8371 outputs full parallel data in straight binary format as shown in Table 1. The parallel output is active when \overline{CS} and \overline{RD} are both low. Any other combination of \overline{CS} and \overline{RD} sets the parallel output to 3-state. BYTE is used for multiword read operations. BYTE is used whenever lower bits on the bus are output on the higher byte of the bus. Refer to Table 1 for ideal output codes.

Table 1. Ideal Input Voltages and Output Codes

DESCRIPTION	ANALOG VALUE	DIGITAL OUTPUT STRAIGHT BINARY	
		BINARY CODE	HEX CODE
Full scale range	$(+V_{ref})$		
Least significant bit (LSB)	$(+V_{ref})/65536$		
+Full scale	$(+V_{ref}) - 1 \text{ LSB}$	1111 1111 1111 1111	FFFF
Midscale	$(+V_{ref})/2$	1000 0000 0000 0000	8000
Midscale – 1 LSB	$(+V_{ref})/2 - 1 \text{ LSB}$	0111 1111 1111 1111	7FFF
Zero	0 V	0000 0000 0000 0000	0000

The output data is a full 16-bit word (D15–D0) on DB15–DB0 pins (MSB–LSB) if BYTE is low.

The result may also be read on an 8-bit bus for convenience. This is done by using only pins DB15–DB8. In this case two reads are necessary: the first as before, leaving BYTE low and reading the 8 most significant bits on pins DB15–DB8, then bringing BYTE high. When BYTE is high, the low bits (D7–D0) appear on pins DB15–D8.

These multiword read operations can be done with multiple active \overline{RD} (toggling) or with \overline{RD} tied low for simplicity.

Table 2. Conversion Data Readout

BYTE	DATA READ OUT	
	DB15–DB8 PINS	DB7–DB0 PINS
High	D7–D0	All one's
Low	D15–D8	D7–D0

RESET

The device can be reset through the use of the combination of \overline{CS} and \overline{CONVST} . Since the BUSY signal is held at high during the conversion, either one of these conditions triggers an internal self-clear reset to the converter.

- Issue a \overline{CONVST} when \overline{CS} is low and internal CONVERT state is high. The falling edge of \overline{CONVST} starts a reset.
- Issue a \overline{CS} (select the device) while internal CONVERT state is high. The falling edge of \overline{CS} causes a reset.

Once the device is reset, all output latches are cleared (set to zeroes) and the BUSY signal is brought low. A new sampling period is started at the falling edge of the BUSY signal immediately after the instant of the internal reset.

ADS8371

SLAS390A – JUNE 2003 – REVISED DECEMBER 2003

LAYOUT

For optimum performance, care should be taken with the physical layout of the ADS8371 circuitry.

As the ADS8371 offers single-supply operation, it will often be used in close proximity with digital logic, microcontrollers, microprocessors, and digital signal processors. The more digital logic present in the design and the higher the switching speed, the more difficult it is to achieve good performance from the converter.

The basic SAR architecture is sensitive to glitches or sudden changes on the power supply, reference, ground connections and digital inputs that occur just prior to latching the output of the analog comparator. Thus, driving any single conversion for an n-bit SAR converter, there are at least n *windows* in which large external transient voltages can affect the conversion result. Such glitches might originate from switching power supplies, nearby digital logic, or high power devices.

The degree of error in the digital output depends on the reference voltage, layout, and the exact timing of the external event.

On average, the ADS8371 draws very little current from an external reference as the reference voltage is internally buffered. If the reference voltage is external and originates from an op amp, make sure that it can drive the bypass capacitor or capacitors without oscillation. A 0.1- μ F bypass capacitor is recommended from pin 1 (REFIN) directly to pin 48 (REFM). REFM and AGND should be shorted on the same ground plane under the device.

The AGND and BDGND pins should be connected to a clean ground point. In all cases, this should be the analog ground. Avoid connections which are too close to the grounding point of a microcontroller or digital signal processor. If required, run a ground trace directly from the converter to the power supply entry point. The ideal layout consists of an analog ground plane dedicated to the converter and associated analog circuitry.

As with the AGND connections, +VA should be connected to a 5-V power supply plane or trace that is separate from the connection for digital logic until they are connected at the power entry point. Power to the ADS8371 should be clean and well bypassed. A 0.1- μ F ceramic bypass capacitor should be placed as close to the device as possible. See Table 3 for the placement of the capacitor. In addition, a 1- μ F to 10- μ F capacitor is recommended. In some situations, additional bypassing may be required, such as a 100- μ F electrolytic capacitor or even a Pi filter made up of inductors and capacitors—all designed to essentially low-pass filter the 5-V supply, removing the high frequency noise.

Table 3. Power Supply Decoupling Capacitor Placement

POWER SUPPLY PLANE SUPPLY PINS	CONVERTER ANALOG SIDE	CONVERTER DIGITAL SIDE
Pin pairs that require shortest path to decoupling capacitors	(4,5), (8,9), (10,11), (13,15), (43,44), (45,46)	(24,25)
Pins that require no decoupling	12, 14	37, 38

PFB (S-PQFP-G48)

PLASTIC QUAD FLATPACK

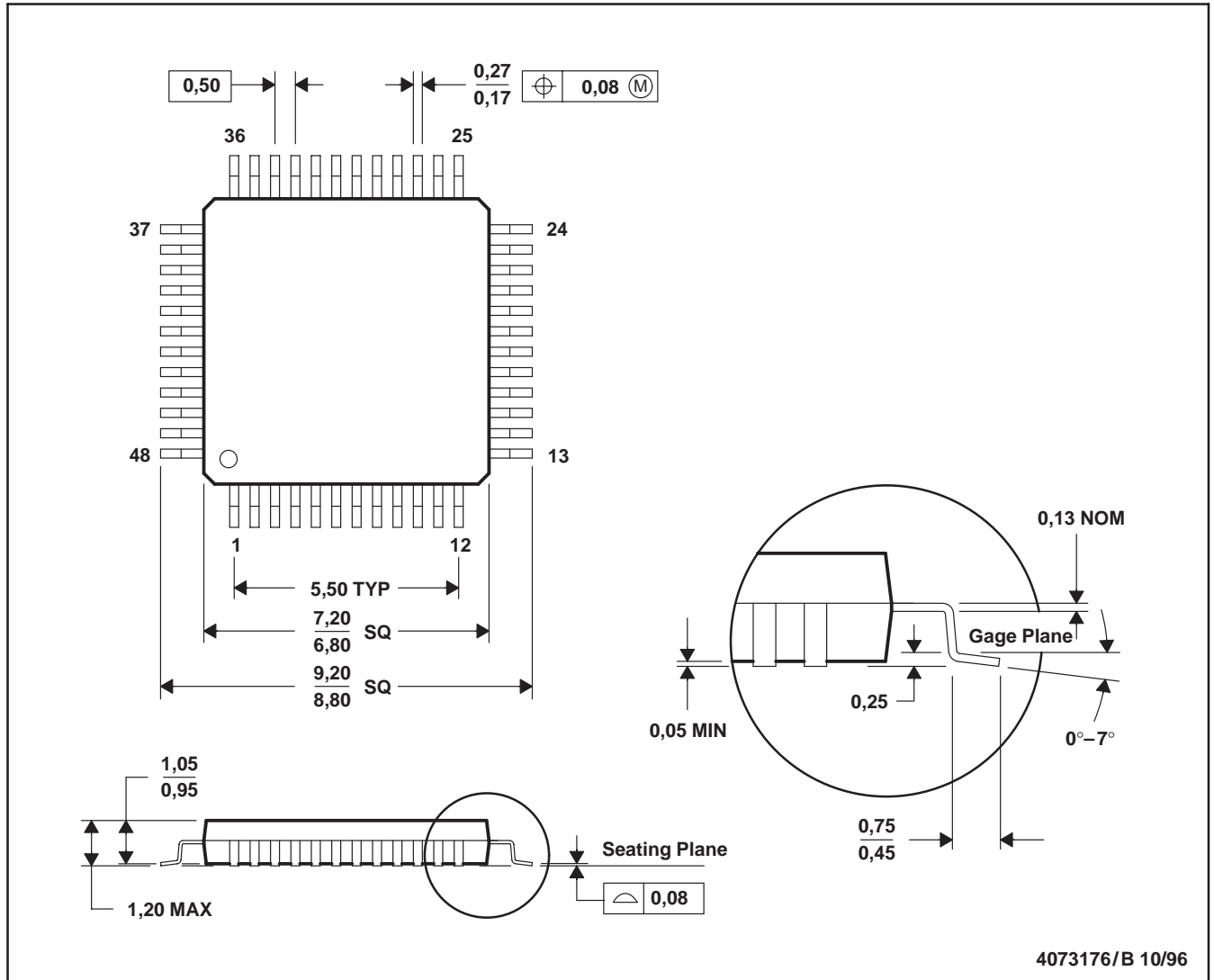

- NOTES: A. All linear dimensions are in millimeters.
 B. This drawing is subject to change without notice.
 C. Falls within JEDEC MS-026

IMPORTANT NOTICE

Texas Instruments Incorporated and its subsidiaries (TI) reserve the right to make corrections, modifications, enhancements, improvements, and other changes to its products and services at any time and to discontinue any product or service without notice. Customers should obtain the latest relevant information before placing orders and should verify that such information is current and complete. All products are sold subject to TI's terms and conditions of sale supplied at the time of order acknowledgment.

TI warrants performance of its hardware products to the specifications applicable at the time of sale in accordance with TI's standard warranty. Testing and other quality control techniques are used to the extent TI deems necessary to support this warranty. Except where mandated by government requirements, testing of all parameters of each product is not necessarily performed.

TI assumes no liability for applications assistance or customer product design. Customers are responsible for their products and applications using TI components. To minimize the risks associated with customer products and applications, customers should provide adequate design and operating safeguards.

TI does not warrant or represent that any license, either express or implied, is granted under any TI patent right, copyright, mask work right, or other TI intellectual property right relating to any combination, machine, or process in which TI products or services are used. Information published by TI regarding third-party products or services does not constitute a license from TI to use such products or services or a warranty or endorsement thereof. Use of such information may require a license from a third party under the patents or other intellectual property of the third party, or a license from TI under the patents or other intellectual property of TI.

Reproduction of information in TI data books or data sheets is permissible only if reproduction is without alteration and is accompanied by all associated warranties, conditions, limitations, and notices. Reproduction of this information with alteration is an unfair and deceptive business practice. TI is not responsible or liable for such altered documentation.

Resale of TI products or services with statements different from or beyond the parameters stated by TI for that product or service voids all express and any implied warranties for the associated TI product or service and is an unfair and deceptive business practice. TI is not responsible or liable for any such statements.

Following are URLs where you can obtain information on other Texas Instruments products and application solutions:

Products		Applications	
Amplifiers	amplifier.ti.com	Audio	www.ti.com/audio
Data Converters	dataconverter.ti.com	Automotive	www.ti.com/automotive
DSP	dsp.ti.com	Broadband	www.ti.com/broadband
Interface	interface.ti.com	Digital Control	www.ti.com/digitalcontrol
Logic	logic.ti.com	Military	www.ti.com/military
Power Mgmt	power.ti.com	Optical Networking	www.ti.com/opticalnetwork
Microcontrollers	microcontroller.ti.com	Security	www.ti.com/security
		Telephony	www.ti.com/telephony
		Video & Imaging	www.ti.com/video
		Wireless	www.ti.com/wireless

Mailing Address: Texas Instruments
Post Office Box 655303 Dallas, Texas 75265