

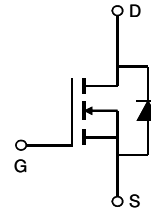
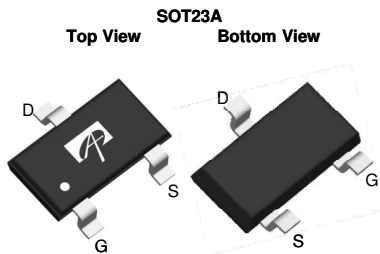
### General Description

The AO3160 is fabricated using an advanced high voltage MOSFET process that is designed to deliver high levels of performance and robustness in popular AC-DC applications.

By providing low  $R_{DS(on)}$ ,  $C_{iss}$  and  $C_{rss}$  along with guaranteed avalanche capability this device can be adopted quickly into new and existing offline power supply designs.

### Product Summary

$V_{DS}$	700V@150°C
$I_D$ (at $V_{GS}=10V$ )	0.04A
$R_{DS(on)}$ (at $V_{GS}=10V$ )	< 500Ω
$R_{DS(on)}$ (at $V_{GS}=4.5V$ )	< 600Ω



### Absolute Maximum Ratings $T_A=25^\circ\text{C}$ unless otherwise noted

Parameter	Symbol	Maximum	Units
Drain-Source Voltage	$V_{DS}$	600	V
Gate-Source Voltage	$V_{GS}$	±20	V
Continuous Drain Current <sup>A,F</sup>	$I_D$	$T_A=25^\circ\text{C}$	0.04
		$T_A=70^\circ\text{C}$	0.03
Pulsed Drain Current <sup>B</sup>	$I_{DM}$	0.12	A
Peak diode recovery $dv/dt$	$dv/dt$	5	V/ns
Power Dissipation <sup>A</sup>	$P_D$	$T_A=25^\circ\text{C}$	1.39
		$T_A=70^\circ\text{C}$	0.89
Junction and Storage Temperature Range	$T_J, T_{STG}$	-50 to 150	°C

### Thermal Characteristics

Parameter	Symbol	Typ	Max	Units
Maximum Junction-to-Ambient <sup>A</sup> $t \leq 10s$	$R_{\theta JA}$	70	90	°C/W
Maximum Junction-to-Ambient <sup>A</sup> Steady-State		100	125	°C/W
Maximum Junction-to-Lead <sup>C</sup> Steady-State	$R_{\theta JL}$	63	80	°C/W

**Electrical Characteristics (T<sub>J</sub>=25°C unless otherwise noted)**

Symbol	Parameter	Conditions	Min	Typ	Max	Units
<b>STATIC PARAMETERS</b>						
BV <sub>DSS</sub>	Drain-Source Breakdown Voltage	I <sub>D</sub> =250μA, V <sub>GS</sub> =0V, T <sub>J</sub> =25°C	600	-	-	V
		I <sub>D</sub> =250μA, V <sub>GS</sub> =0V, T <sub>J</sub> =150°C	-	700	-	
BV <sub>DSS</sub> /ΔT <sub>J</sub>	Zero Gate Voltage Drain Current	I <sub>D</sub> =250μA, V <sub>GS</sub> =0V	-	0.64	-	V/°C
I <sub>DSS</sub>	Zero Gate Voltage Drain Current	V <sub>DS</sub> =600V, V <sub>GS</sub> =0V	-	-	1	μA
		V <sub>DS</sub> =480V, T <sub>J</sub> =125°C	-	-	10	
I <sub>GSS</sub>	Gate-Body leakage current	V <sub>DS</sub> =0V, V <sub>GS</sub> =±20V	-	-	±100	nA
V <sub>GS(th)</sub>	Gate Threshold Voltage	V <sub>DS</sub> =5V, I <sub>D</sub> =8μA	1.4	2	3.2	V
R <sub>DS(on)</sub>	Static Drain-Source On-Resistance	V <sub>GS</sub> =10V, I <sub>D</sub> =0.016A	-	232	500	Ω
	Static Drain-Source On-Resistance	V <sub>GS</sub> =4.5V, I <sub>D</sub> =0.016A	-	315	600	Ω
g <sub>FS</sub>	Forward Transconductance	V <sub>DS</sub> =40V, I <sub>D</sub> =0.016A	-	0.024	-	S
V <sub>SD</sub>	Diode Forward Voltage	I <sub>S</sub> =0.016A, V <sub>GS</sub> =0V	-	0.74	1	V
I <sub>S</sub>	Maximum Body-Diode Continuous Current		-	-	0.04	A
I <sub>SM</sub>	Maximum Body-Diode Pulsed Current		-	-	0.12	A
<b>DYNAMIC PARAMETERS</b>						
C <sub>iss</sub>	Input Capacitance	V <sub>GS</sub> =0V, V <sub>DS</sub> =25V, f=1MHz	-	10	15	pF
C <sub>oss</sub>	Output Capacitance		-	1.8	3	pF
C <sub>rss</sub>	Reverse Transfer Capacitance		-	0.7	1	pF
R <sub>g</sub>	Gate resistance	V <sub>GS</sub> =0V, V <sub>DS</sub> =0V, f=1MHz	5	10	15	Ω
<b>SWITCHING PARAMETERS</b>						
Q <sub>g</sub>	Total Gate Charge	V <sub>GS</sub> =10V, V <sub>DS</sub> =400V, I <sub>D</sub> =0.01A	-	1	1.5	nC
Q <sub>gs</sub>	Gate Source Charge		-	0.1	0.15	nC
Q <sub>gd</sub>	Gate Drain Charge		-	0.52	0.8	nC
t <sub>D(on)</sub>	Turn-On DelayTime	V <sub>GS</sub> =10V, V <sub>DS</sub> =300V, I <sub>D</sub> =0.01A, R <sub>G</sub> =6Ω	-	4	12	ns
t <sub>r</sub>	Turn-On Rise Time		-	5.2	8	ns
t <sub>D(off)</sub>	Turn-Off DelayTime		-	12.5	19	ns
t <sub>f</sub>	Turn-Off Fall Time		-	55	82.5	ns
t <sub>rr</sub>	Body Diode Reverse Recovery Time	I <sub>F</sub> =0.016A, dI/dt=100A/μs, V <sub>DS</sub> =300V	-	105	160	ns
Q <sub>rr</sub>	Body Diode Reverse Recovery Charge	I <sub>F</sub> =0.016A, dI/dt=100A/μs, V <sub>DS</sub> =300V	-	9.5	14.3	nC

A: The value of R<sub>θJA</sub> is measured with the device mounted on 1 in<sup>2</sup> FR-4 board with 2oz. Copper, in a still air environment with T<sub>A</sub>=25° C. The value in any given application depends on the user's specific board design.

B: Repetitive rating, pulse width limited by junction temperature.

C: The R<sub>θJA</sub> is the sum of the thermal impedance from junction to lead R<sub>θJL</sub> and lead to ambient.

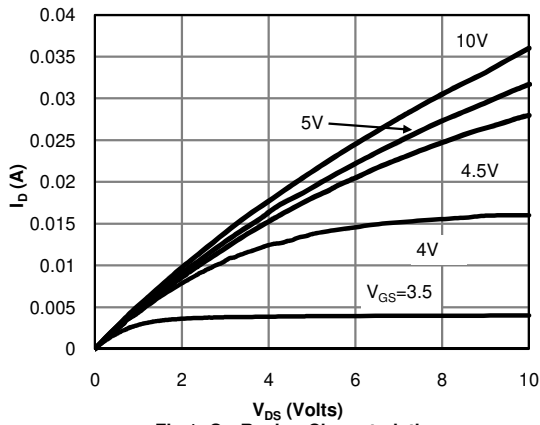
D: The static characteristics in Figures 1 to 6 are obtained using <300 μs pulses, duty cycle 0.5% max.

E: These tests are performed with the device mounted on 1 in<sup>2</sup> FR-4 board with 2oz. Copper, in a still air environment with T<sub>A</sub>=25° C. The SOA curve provides a single pulse rating.

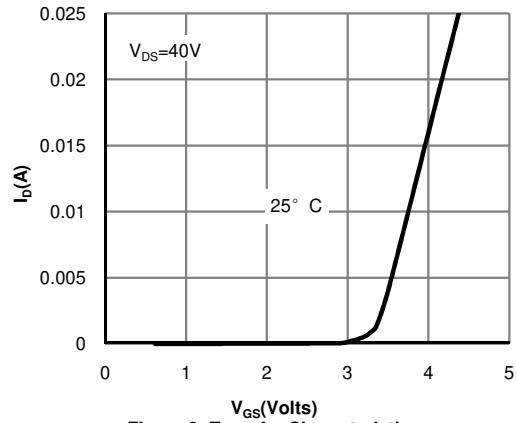
F: The current rating is based on the t ≤ 10s thermal resistance rating.

THIS PRODUCT HAS BEEN DESIGNED AND QUALIFIED FOR THE CONSUMER MARKET. APPLICATIONS OR USES AS CRITICAL COMPONENTS IN LIFE SUPPORT DEVICES OR SYSTEMS ARE NOT AUTHORIZED. AOS DOES NOT ASSUME ANY LIABILITY ARISING OUT OF SUCH APPLICATIONS OR USES OF ITS PRODUCTS. AOS RESERVES THE RIGHT TO IMPROVE PRODUCT DESIGN, FUNCTIONS AND RELIABILITY WITHOUT NOTICE.

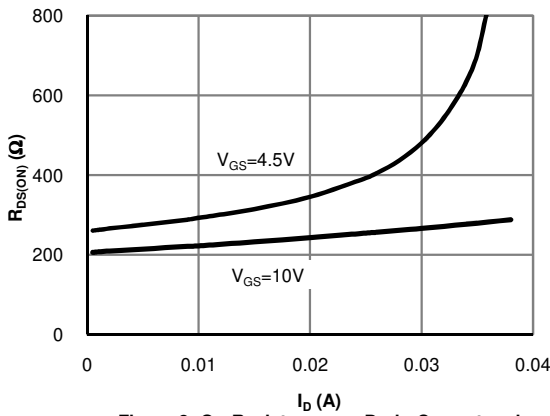
**TYPICAL ELECTRICAL AND THERMAL CHARACTERISTICS**



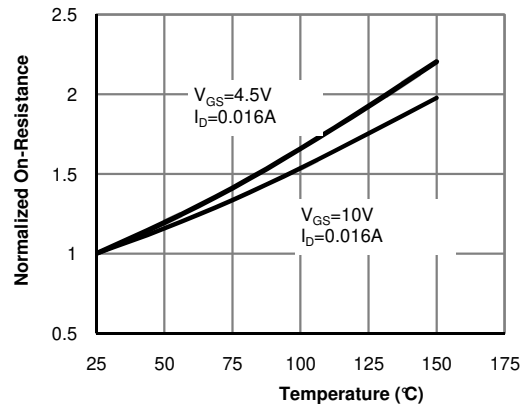
**Fig 1: On-Region Characteristics**



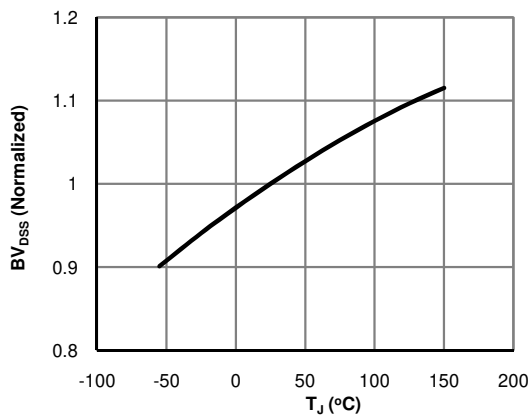
**Figure 2: Transfer Characteristics**



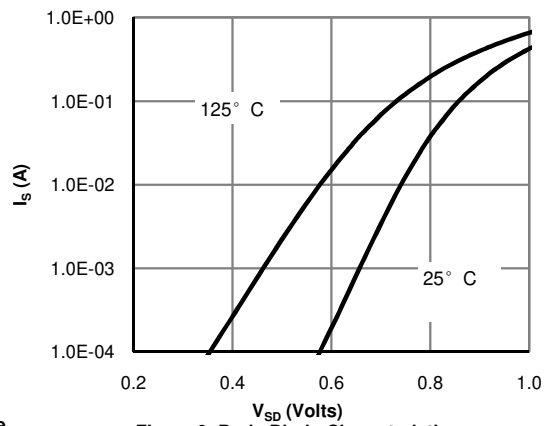
**Figure 3: On-Resistance vs. Drain Current and Gate Voltage**



**Figure 4: On-Resistance vs. Junction Temperature**

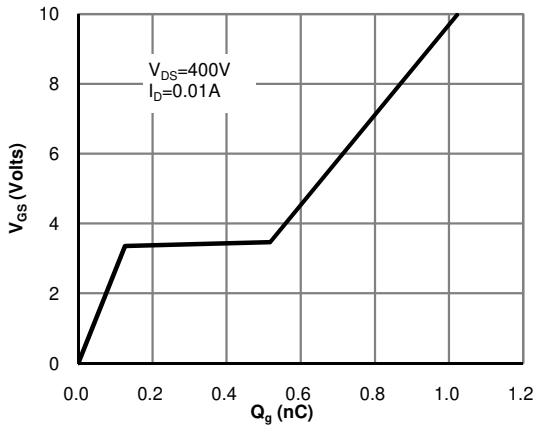


**Figure 5: Break Down vs. Junction Temperature**

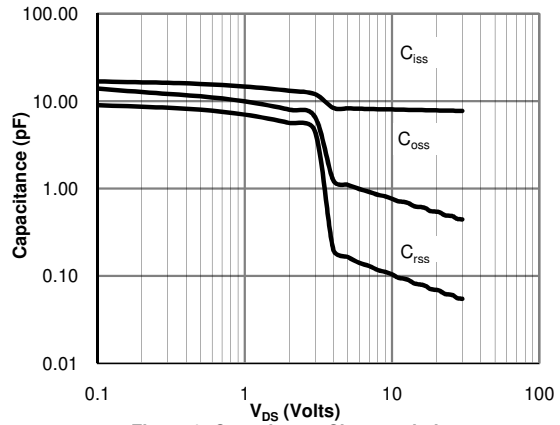


**Figure 6: Body-Diode Characteristics**

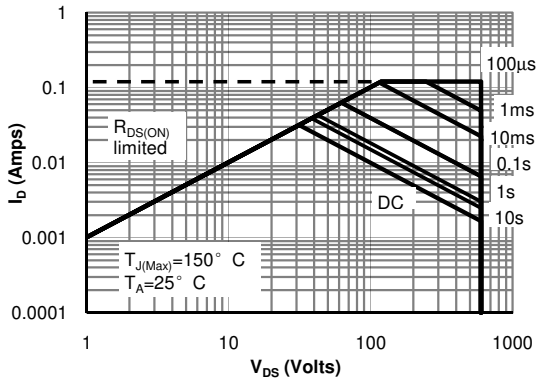
**TYPICAL ELECTRICAL AND THERMAL CHARACTERISTICS**



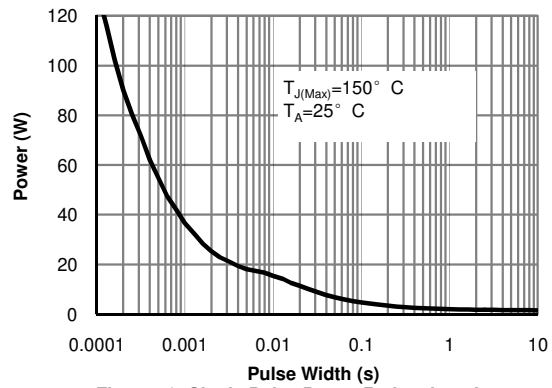
**Figure 7: Gate-Charge Characteristics**



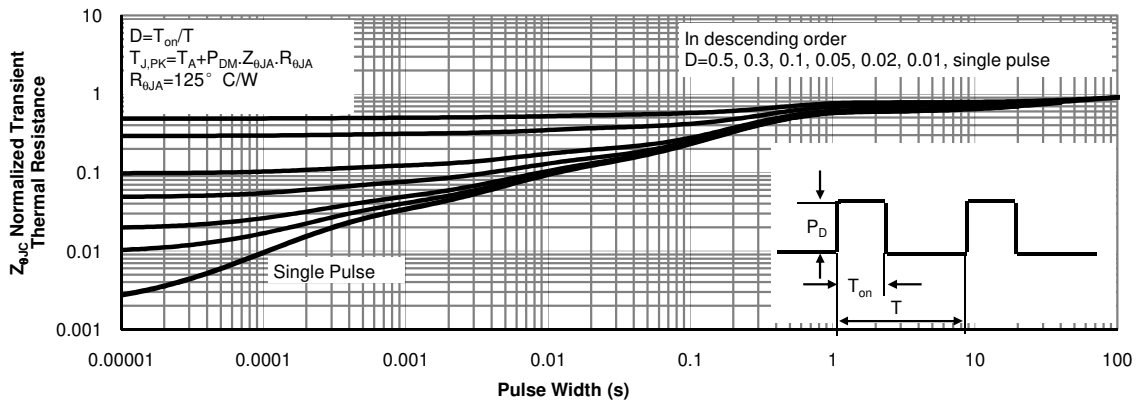
**Figure 8: Capacitance Characteristics**



**Figure 9: Maximum Forward Biased Safe Operating Area (Note E)**

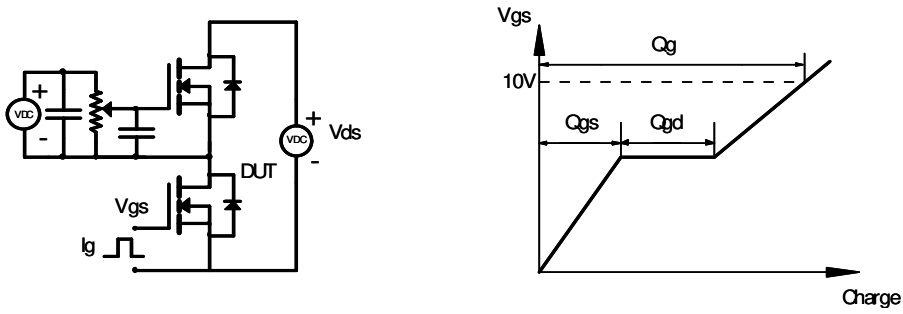


**Figure 10: Single Pulse Power Rating Junction-to-Ambient (Note E)**

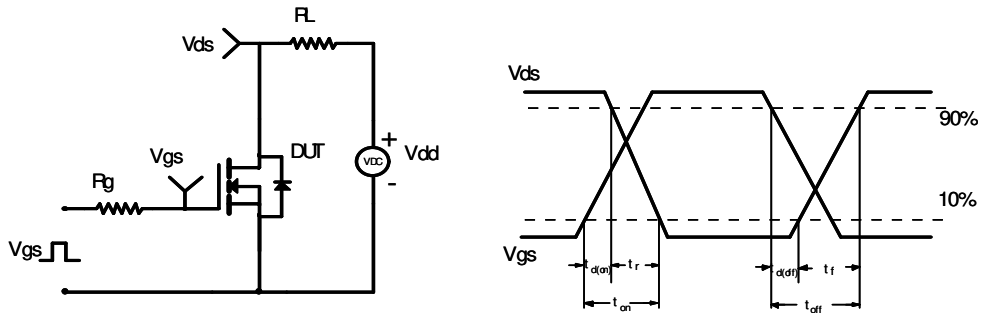


**Figure 11: Normalized Maximum Transient Thermal Impedance (Note E)**

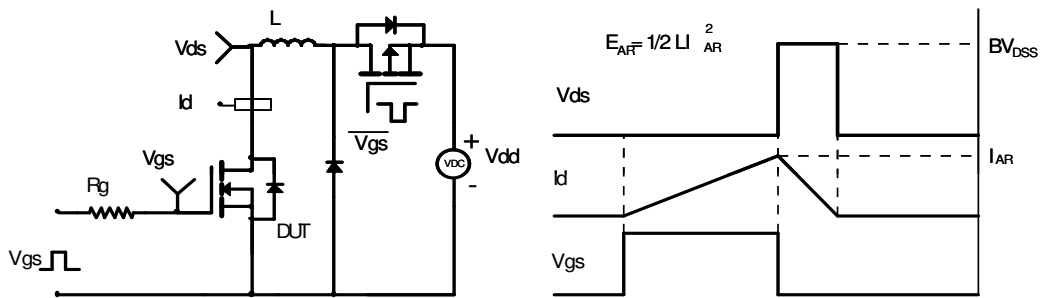
Gate Charge Test Circuit & Waveform



Resistive Switching Test Circuit & Waveforms



Unclamped Inductive Switching (UIS) Test Circuit & Waveforms



Diode Recovery Test Circuit & Waveforms

