



LIGITEK

LIGITEK ELECTRONICS CO.,LTD.
Property of Ligitek Only

FOUR DIGIT LED DISPLAY (0.39 Inch)

LFD415/63-XX/KP126

DATA SHEET

DOC. NO : QW0905-LFD415/63-XX/KP126

REV. : A

DATE : 17 - May. - 2005



Package Dimensions

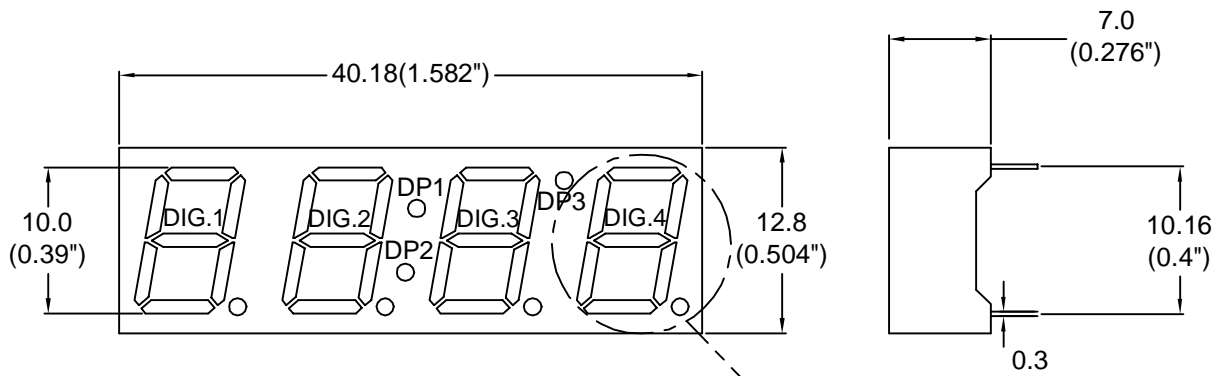

LFD415/63-XX/KP126
LIGITEK

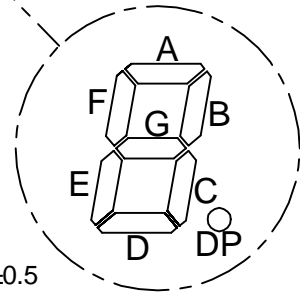
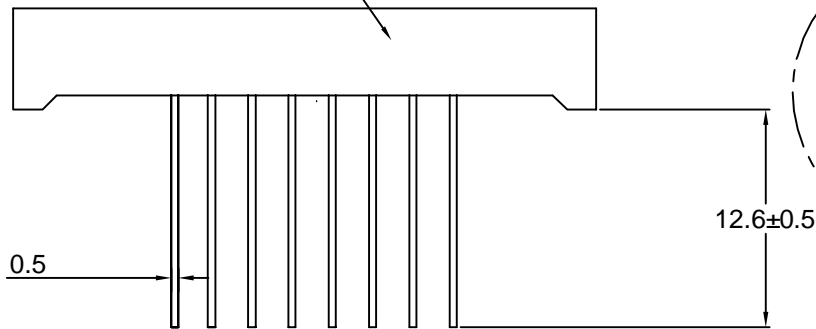

PIN NO.1 →

2.54X7=17.78
(0.7'')

Note : 1.All dimension are in millimeters and (Inch) tolerance is $\pm 0.25\text{mm}$ unless otherwise noted.
2.Specifications are subject to change without notice.



Internal Circuit Diagram

LFD4153-XX/KP126

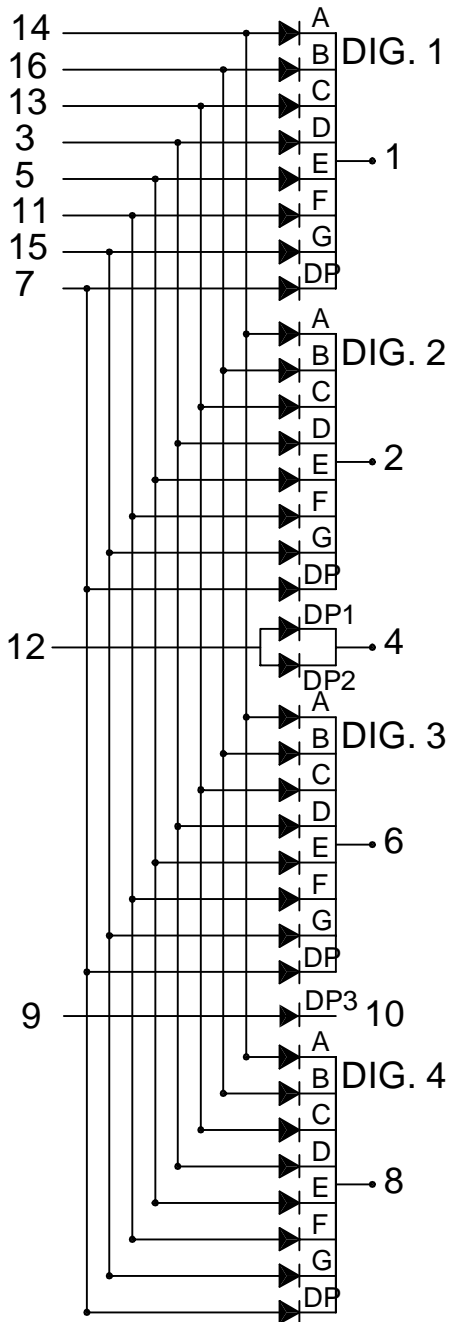

LFD4163-XX/KP126

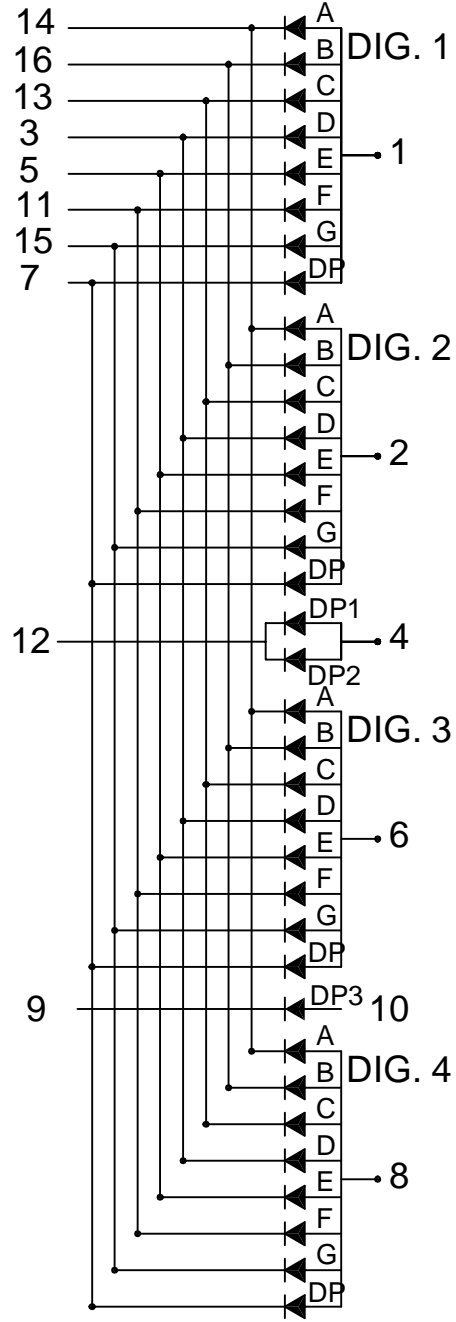

**Electrical Connection**

PIN NO.	LFD4153-XX/KP126	PIN NO.	LFD4163-XX/KP126
1	Common Cathode Dig.1	1	Common Anode Dig.1
2	Common Cathode Dig.2	2	Common Anode Dig.2
3	Anode D	3	Cathode D
4	Cathode DP1,DP2	4	Anode DP1,DP2
5	Anode E	5	Cathode E
6	Common Cathode Dig.3	6	Common Anode Dig.3
7	Anode DP	7	Cathode DP
8	Common Cathode Dig.4	8	Common Anode Dig.4
9	Anode DP3	9	Cathode DP3
10	Cathode DP3	10	Anode DP3
11	Anode F	11	Cathode F
12	Anode DP1,DP2	12	Cathode DP1,DP2
13	Anode C	13	Cathode C
14	Anode A	14	Cathode A
15	Anode G	15	Cathode G
16	Anode B	16	Cathode B



Absolute Maximum Ratings at Ta=25

Parameter	Symbol	Ratings		UNIT
		Y		
Forward Current Per Chip	IF	20		mA
Peak Forward Current Per Chip (Duty 1/10,0.1ms Pulse Width)	IFP	80		mA
Power Dissipation Per Chip	PD	60		mW
Reverse Current Per Any Chip	Ir	10		μA
Operating Temperature	Topr	-25 ~ +85		
Storage Temperature	Tstg	-25 ~ +85		
Solder Temperature 1-16 Inch Below Seating Plane For 3 Seconds At 260				

Part Selection And Application Information(Ratings at 25)

PART NO	CHIP		Common Cathode or Anode	P (nm)	(nm)	Electrical					IV-M
	Material	Emitted				Vf(v)			Iv(mcd)		
						Min.	Typ.	Max.	Min.	Typ.	
LFD4153-XX/KP126	GaAsP/GaP	Yellow	Common Cathode	585	35	1.7	2.1	2.6	1.0	2.35	2:1
LFD4163-XX/KP126			Common Anode								

Note : 1. The forward voltage data did not including ±0.1V testing tolerance.
2. The luminous intensity data did not including ±15% testing tolerance.



Test Condition For Each Parameter

Parameter	Symbol	Unit	Test Condition
Forward Voltage Per Chip	Vf	volt	If=20mA
Luminous Intensity Per Chip	Iv	mcd	If=10mA
Peak Wavelength	p	nm	If=20mA
Spectral Line Half-Width		nm	If=20mA
Reverse Current Any Chip	Ir	μ A	Vr=5V
Luminous Intensity Matching Ratio	IV-M		



Typical Electro-Optical Characteristics Curve

Y CHIP

Fig.1 Forward current vs. Forward Voltage

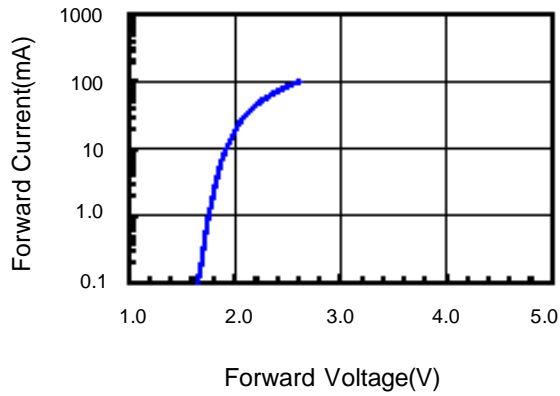

Fig.2 Relative Intensity vs. Forward Current

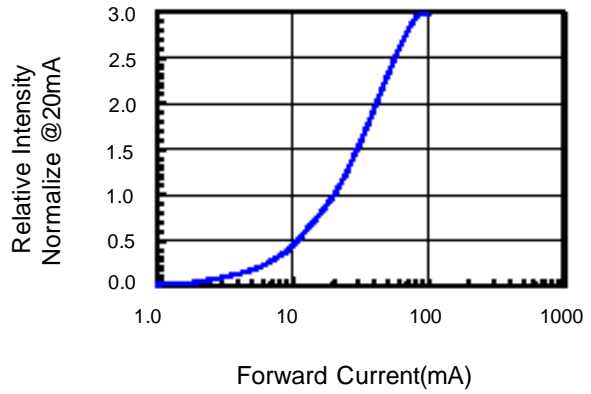

Fig.3 Forward Voltage vs. Temperature

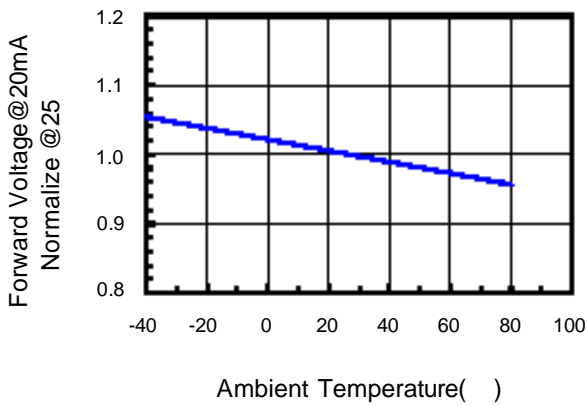

Fig.4 Relative Intensity vs. Temperature

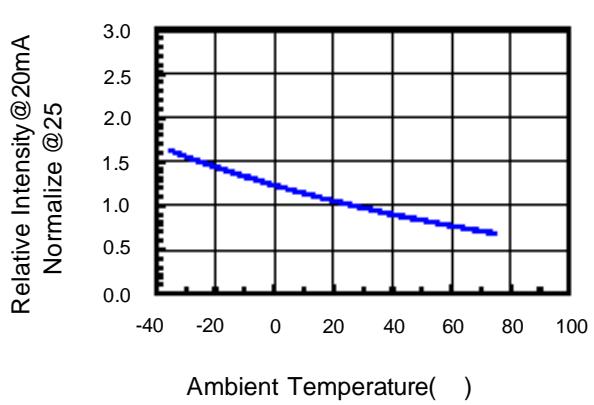
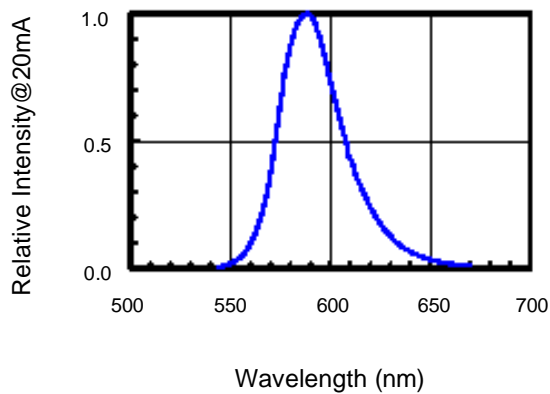

Fig.5 Relative Intensity vs. Wavelength



**Reliability Test:**

Test Item	Test Condition	Description	Reference Standard
Operating Life Test	1.Under Room Temperature 2.If=10mA 3.t=1000 hrs (-24hrs, +72hrs)	This test is conducted for the purpose of determining the resistance of a part in electrical and thermal stressed.	MIL-STD-750: 1026 MIL-STD-883: 1005 JIS C 7021: B-1
High Temperature Storage Test	1.Ta=105 ±5 2.t=1000 hrs (-24hrs, +72hrs)	The purpose of this is the resistance of the device which is laid under condition of high temperature for hours.	MIL-STD-883:1008 JIS C 7021: B-10
Low Temperature Storage Test	1.Ta=-40 ±5 2.t=1000 hrs (-24hrs, +72hrs)	The purpose of this is the resistance of the device which is laid under condition of low temperature for hours.	JIS C 7021: B-12
High Temperature High Humidity Test	1.Ta=65 ±5 2.RH=90%~95% 3.t=240hrs ±2hrs	The purpose of this test is the resistance of the device under tropical for hours.	MIL-STD-202:103B JIS C 7021: B-11
Thermal Shock Test	1.Ta=105 ±5 & -40 ±5 (10min) (10min) 2.total 10 cycles	The purpose of this is the resistance of the device to sudden extreme changes in high and low temperature.	MIL-STD-202: 107D MIL-STD-750: 1051 MIL-STD-883: 1011
Solder Resistance Test	1.T.Sol=260 ±5 2.Dwell time= 10 ±1sec.	This test intended to determine the thermal characteristic resistance of the device to sudden exposures at extreme changes in temperature when soldering the lead wire.	MIL-STD-202: 210A MIL-STD-750: 2031 JIS C 7021: A-1
Solderability Test	1.T.Sol=230 ±5 2.Dwell time=5 ±1sec	This test intended to see soldering well performed or not.	MIL-STD-202: 208D MIL-STD-750: 2026 MIL-STD-883: 2003 JIS C 7021: A-2