

### FEATURES

1. Compact DIP type SSR that's ideal for AC load control
2. Supports 0.3 A, 0.6 A, 0.9 A and 1.2 A ON-state RMS currents.
3. The 1.2 A type saves space with a DIP 8-pin package. (Competitor only provides a 16-pin type.)

5. High dielectric strength: 5,000 V AC (between input and output)
6. Two types available: Zero-cross type and Non-zero-cross type

### TYPICAL APPLICATIONS

1. Home appliances (air conditioners, microwave ovens, washing machines, personal hygiene systems, refrigerators, fan heaters, inductive heating cooker, and water heaters, etc.)
2. Industrial equipment market.

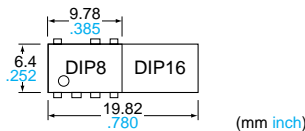
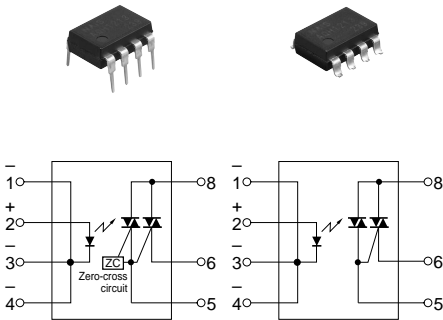

4. Only ours handles both 100 and 200 V AC loads  
This relay handles both voltages in a single product. It is not necessary for users that use both types to manage separate part numbers.

### TYPES

Type	Output rating*		Type	Part No.				Packing quantity	
				Through hole terminal	Surface-mount terminal			Tube	Tape and reel
	Repetitive peak OFF-state voltage	ON-state RMS current			Tube packing style	Tape and reel packing style			
			Picked from the 1/2/3/4-pin side	Picked from the 5/6/8-pin side					
AC type	600 V	0.3 A	Zero-cross	AQH0213	AQH0213A	AQH0213AX	AQH0213AZ	1 tube contains 40 pcs. 1 batch contains 400 pcs.	1,000 pcs.
		0.6 A		AQH1213	AQH1213A	AQH1213AX	AQH1213AZ		
		0.9 A		AQH2213	AQH2213A	AQH2213AX	AQH2213AZ		
		1.2 A		AQH3213	AQH3213A	AQH3213AX	AQH3213AZ		
		0.3 A	Non zero-cross	AQH0223	AQH0223A	AQH0223AX	AQH0223AZ		
		0.6 A		AQH1223	AQH1223A	AQH1223AX	AQH1223AZ		
		0.9 A		AQH2223	AQH2223A	AQH2223AX	AQH2223AZ		
		1.2 A		AQH3223	AQH3223A	AQH3223AX	AQH3223AZ		

\*Indicate the repetitive peak OFF-state voltage and ON-state RMS current: peak AC.  
Note: For space reasons, the SMD terminal shape indicator "A" and the package type indicator "X" and "Z" are omitted from the seal.

### RATING

#### 1. Absolute maximum ratings (Ambient temperature: 25°C 77°F)

Item		Symbol	AQH0213	AQH0223	AQH1213	AQH1223	AQH2213	AQH2223	AQH3213	AQH3223	Remarks
Input	LED forward current	I <sub>F</sub>	50 mA								
	LED reverse voltage	V <sub>R</sub>	6 V								
	Peak forward current	I <sub>FP</sub>	1 A								
Output	Repetitive peak OFF-state voltage	V <sub>DRM</sub>	600 V								
	ON-state RMS current	I <sub>T(RMS)</sub>	0.3 A	0.6 A		0.9 A		1.2 A			
	Non-repetitive surge current	I <sub>TSM</sub>	3 A	6 A		9 A		12 A			
I/O isolation voltage		V <sub>iso</sub>	5,000 V AC								
Temperature limits	Operating	T <sub>opr</sub>	-30°C to +85°C -22°F to +185°F								
	Storage	T <sub>stg</sub>	-40°C to +125°C -40°F to +257°F								

# AQ-H

## 2. Electrical characteristics (Ambient temperature: 25°C 77°F)

Item		Symbol	AQH0213	AQH1213	AQH2213	AQH3213	AQH0223	AQH1223	AQH2223	AQH3223	Condition
Input	LED dropout voltage	Typical	1.18 V						I <sub>F</sub> = 10 mA		
		Maximum	1.3 V								
	LED reverse current	Typical	—						V <sub>R</sub> = 6 V		
		Maximum	10 μA								
Output	Peak OFF-state current	Typical	—						I <sub>F</sub> = 0 mA V <sub>DRM</sub> = 600 V		
		Maximum	100 μA								
	Peak ON-state voltage	Typical	—						I <sub>F</sub> = 10 mA I <sub>TM</sub> = Max.		
		Maximum	2.5 V								
	Holding current	Typical	—								
Maximum		25 mA									
Critical rate of rise of OFF-state voltage	Minimum	dv/dt	200 V/μs						V <sub>DRM</sub> = 600 V × 1/√2		
Transfer characteristics	Trigger LED current*	Maximum	10 mA						V <sub>D</sub> = 6 V R <sub>L</sub> = 100 Ω		
	Zero-cross voltage**	Maximum	50 V			—			I <sub>F</sub> = 10 mA		
	Turn on time***	Maximum	10 μs						I <sub>F</sub> = 20 mA V <sub>D</sub> = 6 V R <sub>L</sub> = 100 Ω		
	I/O isolation resistance	Minimum	R <sub>iso</sub>						50 GΩ		

Notes: \*Recommended LED current I<sub>FT</sub>: 20 mA

\*\*Applicable part No.: AQH0213, AQH1213, AQH2213 and AQH3213.

\*\*\*Turn on time

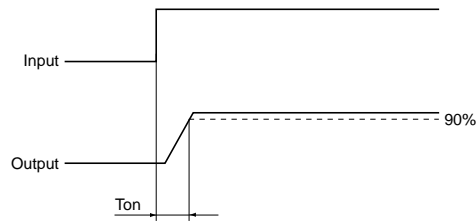

## DIMENSIONS

mm inch

Through hole terminal type

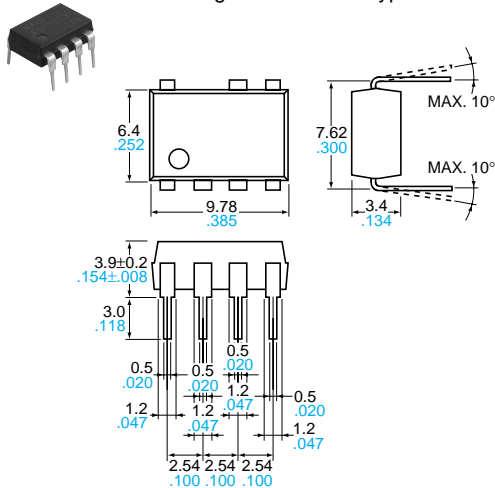

Terminal thickness: 0.25 .010  
General tolerance: ±0.1 ±.004

Surface mount terminal type

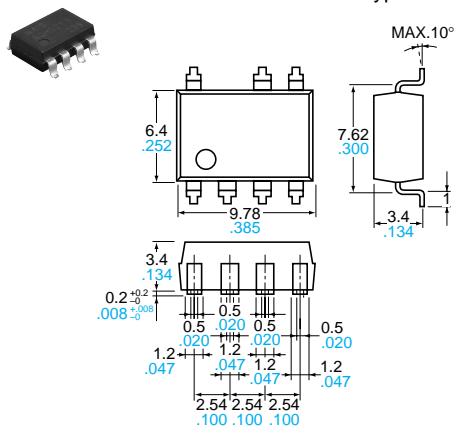

Terminal thickness: 0.25 .010  
General tolerance: ±0.1 ±.004

PC board pattern (BOTTOM VIEW)

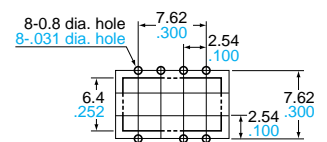

Tolerance: ±0.1 ±.004

Recommended mounting pad (TOP VIEW)

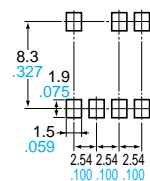

Tolerance: ±0.1 ±.004

# SCHEMATIC AND WIRING DIAGRAMS

Notes: E<sub>i</sub>: Power source at input side; I<sub>F</sub>: Trigger LED forward current; V<sub>L</sub>: Load voltage; I<sub>L</sub>: Load current;

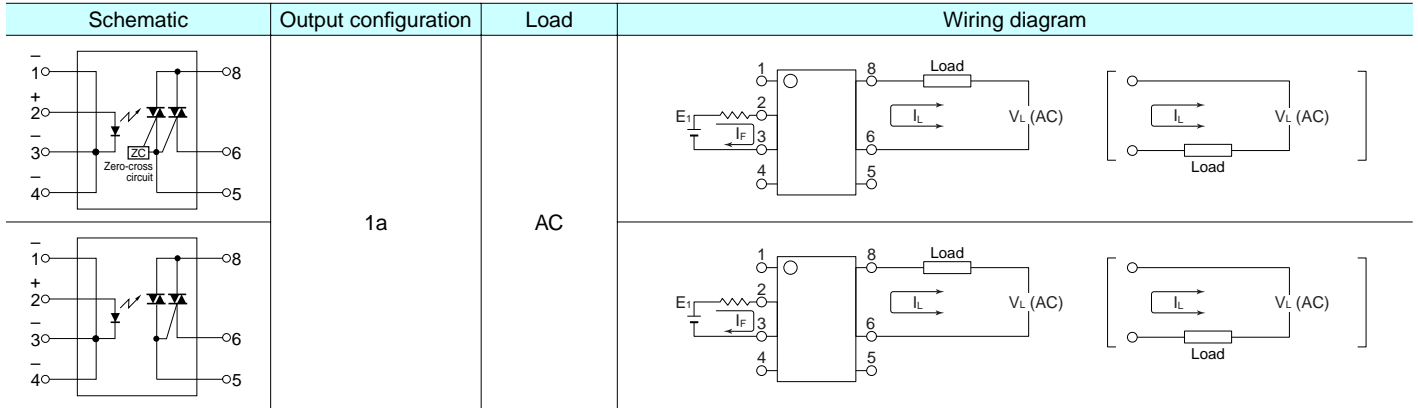

## REFERENCE DATA

1. ON-state RMS current vs. Ambient temperature characteristics

Allowable ambient temperature: -30°C to +85°C -22°F to +185°F

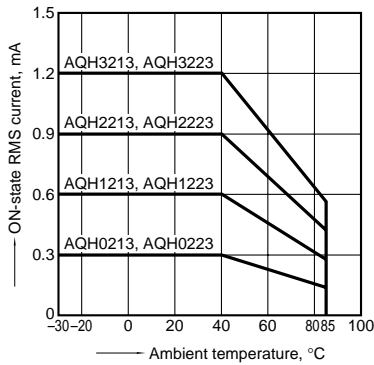

2. On voltage vs. Ambient temperature characteristics

LED current: 10 mA; ON current: Max. Measured portion: between terminals 6 and 8

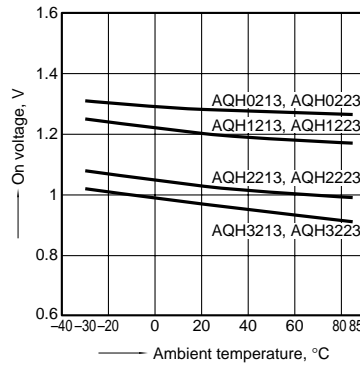

3. Trigger LED current vs. Ambient temperature characteristics

Load voltage: 6 V DC; Load resistance: 100Ω

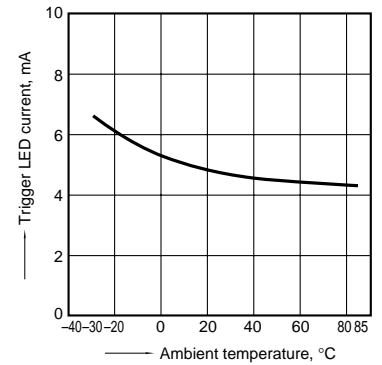

4. LED dropout voltage vs. Ambient temperature characteristics

LED current: 10 to 50 mA

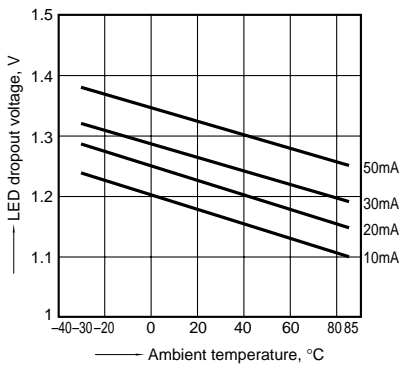

5. Turn on time vs. LED current characteristics

Load voltage: 6 V DC; Load resistance: 100Ω Measured portion: between terminals 6 and 8

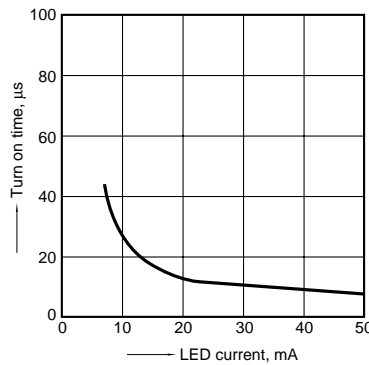

6. Repetitive peak OFF-state current vs. Load voltage characteristics

LED current: 0 mA; Measured portion: between terminals 6 and 8; Ambient temperature: 25°C 77°F

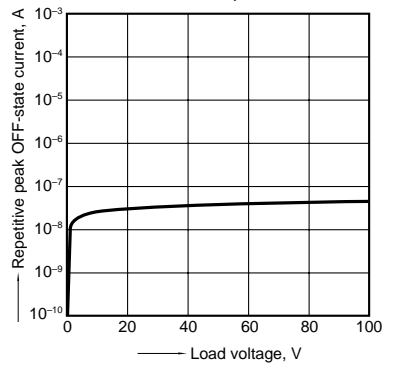

7. Hold current vs. Ambient temperature characteristics

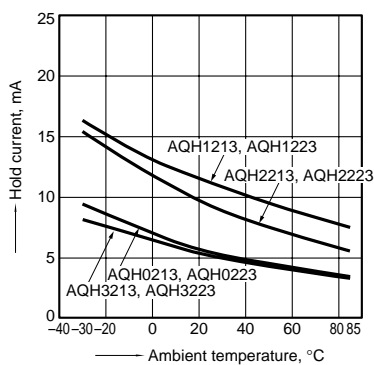

8. Zero-cross voltage vs. Ambient temperature characteristics

LED current: 10 mA

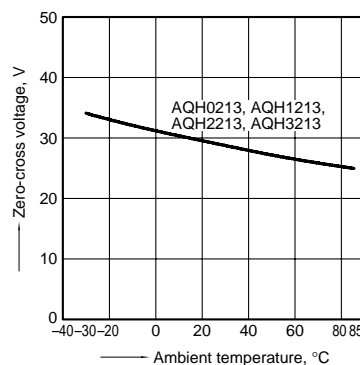

**CAUTIONS FOR USE**

**1. For cautions regarding use, please refer to '03-'04 Solid State Relays catalog.**

**2. The internal IC could be damaged if a short forms between the I/O terminals while the solid state relay is powered.**

**3. Output spike voltages**

1) The figure below shows an ordinary circuit. Please add a snubber circuit or varistor, as noise/surge on the load side could damage the unit or cause malfunctions.

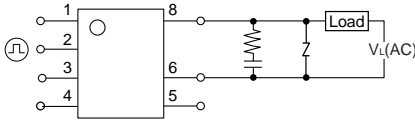

Note) Connection of an external resistor, etc., to terminal No. 5 (gate) is not necessary.

2) Even if spike voltages generated at the load are limited with a clamp diode if the circuit wires are long, spike voltages will occur by inductance. Keep wires as short as possible to minimize inductance.

**4. Ripple in the input power supply**

1) For LED operate current at  $E_{min}$ , maintain min. 10 mA  
 2) Keep the LED operate current at 50 mA or less at  $E_{max}$ .

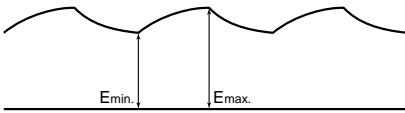

**5. When soldering terminals, keep soldering time to within 10s at 260°C 500°F**

**6. Cleaning**

The solid state relay forms an optical path by coupling a light-emitting diode (LED) and photodiode via transparent silicon resin.

For this reason, avoid ultrasonic cleansing if at all possible.

We recommend cleaning with an organic solvent. If you cannot avoid using ultrasonic cleansing, please ensure that the following conditions are met, and check beforehand for defects.

- Frequency: 27 to 29 kHz
- Ultrasonic output: No greater than 0.25 W/cm<sup>2</sup>
- Cleaning time: No longer than 30 seconds
- Cleanser used: Asahiklin AK-225
- Other: Submerge in solvent in order to prevent the PCB and elements from being contacted directly by the ultrasonic vibrations.

Note: Applies to unit area ultrasonic output for ultrasonic baths.

**7. Soldering**

- 1) When soldering PC board terminals, keep soldering time to within 10 s at 260°C 500°F.
- 2) When soldering surface-mount terminals, the following conditions are recommended.

(1) IR (Infrared reflow) soldering method

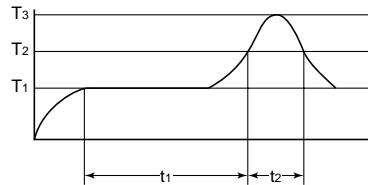

$T_1 = 155 \text{ to } 165^\circ\text{C } 311 \text{ to } 329^\circ\text{F}$   
 $T_2 = 180^\circ\text{C } 200^\circ\text{C } 356 \text{ to } 392^\circ\text{F}$   
 $T_3 = 245^\circ\text{C } 473^\circ\text{F or less}$   
 $t_1 = 120 \text{ s or less}$   
 $t_2 = 30 \text{ s or less}$

(2) Vapor phase soldering method

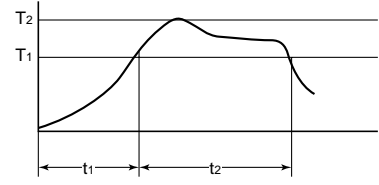

$T_1 = 180 \text{ to } 200^\circ\text{C } 366 \text{ to } 392^\circ\text{F}$   
 $T_2 = 215^\circ\text{C } 419^\circ\text{F or less}$   
 $t_1 = 40 \text{ s}$   
 $t_2 = 90 \text{ s or less (40 s: SOP type)}$

(3) Double wave soldering method

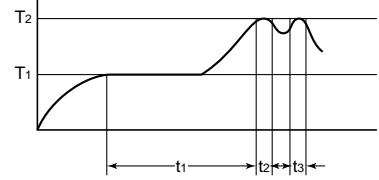

$T_1 = 155 \text{ to } 165^\circ\text{C } 311 \text{ to } 329^\circ\text{F}$   
 $T_2 = 260^\circ\text{C } 500^\circ\text{F or less}$   
 $t_1 = 60 \text{ s or less}$   
 $t_2+t_3 = 5 \text{ s or less}$

(4) Soldering iron method

Tip temperature: 280 to 300°C 536 to 572°F

Wattage: 30 to 60 W

Soldering time: within 5 seconds

(5) Others

Check mounting conditions before using other soldering methods (hot-air, hot plate, pulse heater, etc.)

• The temperature profile indicates the temperature of the soldered terminal on the surface of the PC board. The ambient temperature may increase excessively. Check the temperature under mounting conditions.

• The conditions for the infrared reflow soldering apply when preheating using the VPS method.

**8. The following shows the packaging format**

1) Tape and reel

mm inch

Type	Tape dimensions	Dimensions of paper tape reel
8-pin SMD type	<p>(1) When picked from 1/2/3/4-pin side: Part No. AQH○○○○AX (Shown above)                      (2) When picked from 5/6/8-pin side: Part No. AQH○○○○AZ</p>	

## 2) Tube

Devices are packaged in a tube so pin No. 1 is on the stopper B side. Observe correct orientation when mounting them on PC boards.

(DIP type)

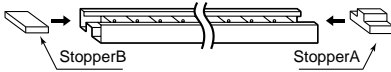

## 9. Transportation and storage

1) Extreme vibration during transport will warp the lead or damage the relay.

Handle the outer and inner boxes with care.

2) Storage under extreme conditions will cause soldering degradation, external appearance defects, and deterioration of the characteristics. The following storage conditions are recommended:

- Temperature: 0 to 45°C 32 to 113°F
- Humidity: Less than 70% R.H.
- Atmosphere: No harmful gasses such as sulfuric acid gas, minimal dust.

### Internet Homepage

- ◆ North America : <http://www.aromat.com/>
- ◆ Europe : <http://www.mew-europe.com/>
- ◆ Asia & others : <http://www.nais-e.com/>
  - (Japanese) : <http://www.mac-j.co.jp/>
  - (Chinese) : <http://www.cmew.com.cn/>

These materials are printed on ECF pulp.  
These materials are printed with earth-friendly vegetable-based (soybean oil) ink.



Please contact .....

## Matsushita Electric Works, Ltd.

Automation Controls Company

■ Head Office: 1048, Kadoma, Kadoma-shi, Osaka 571-8686, Japan

■ Telephone: Japan (81) Osaka (06) 6908-1050

■ Facsimile: Japan (81) Osaka (06) 6908-5781

<http://www.nais-e.com/>

COPYRIGHT © 2003 All Rights Reserved