

WESTCODE

An IXYS Company

Date:- 18 Mar, 2005

Data Sheet Issue:- 1

Ultra Rapid Semiconductor Protection Fuse European Square Body Fuses



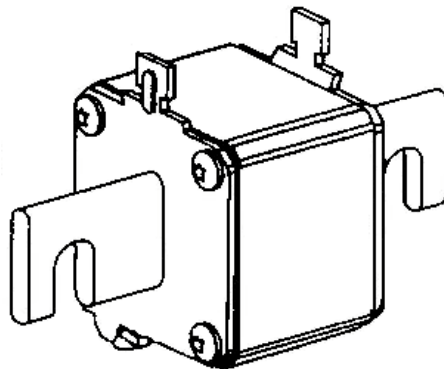







French Standard Blade Contact
Voltage Rating 500V to 690V
Current Ratings 63A to 1400A
aR Characteristics
Sizes 0, 1, 2, 3













Key Features:

- ❖ Extremely high interrupting rating fuses for the protection of power semiconductors in accordance with IEC Standard 60269.1 and 4.
- ❖ Exceptionally low I^2t , power losses
- ❖ Highly reliable low voltage trip indicator system which conforms to UL, IEC, DIN and VDE standards
- ❖ Non Magnetic construction
- ❖ Increased technical performance gives higher ratings and a reduction in volume and weight
- ❖ Microswitch system reference : MS 3V 1-5
- ❖ Fuse holder type : SI DIN 80









Main Characteristics:

Size	Voltage	Ref:		Current rating I_N (A)	Pre-arcing $I^2t @ 1 \text{ ms}$ I^2t_p (kA ² s)	Total Clearing $I^2t @ U_N$ (kA ² s)	Watt Losses		Tested Interrupting rating
							$0.8I_N$	I_N	
0	690V	069UF0A0063B		63	0.2	1.1	7.5	14	200kA @660V (IEC) 170kA @700V (USA)
		069UF0A0080B		80	0.33	1.75	9.5	19	
		069UF0A0100B		100	0.47	2.5	13	26	
		069UF0A0125B		125	0.85	4.5	15	30	
		069UF0A0160B		160	1.6	8.5	18.5	37	
		069UF0A0200B		200	3	15.5	21.5	43	
		069UF0A0250B		250	5.8	30	25	50	
		069UF0A0315B		315	12	62	22.5	55	
		069UF0A0350B		350	15.5	80	30	60	
		069UF0A0400B		400	23	120	32.5	65	

Notes: Minimum operating voltage for integrated trip indicator = 20V
Microswitch reference : MS 3V 1-5











Size	Voltage	Ref:		Current rating I_N (A)	Pre-arcing $I^2t @ 1 \text{ ms}$ I^2t_p (kA ² s)	Total Clearing $I^2t @ U_N$ (kA ² s)	Watt Losses		Tested Interrupting rating
							$0.8I_N$	I_N	
1	690V	069UF1B0200B		200	2.6	13.5	22.5	45	200kA @660V (IEC) 170kA @700V (USA)
		069UF1B0250B		250	4.7	25	25.5	52	
		069UF1B0315B		315	7.5	40	32.5	65	
		069UF1B0350B		350	10.5	55	33.5	67	
		069UF1B0400B		400	19	100	34	68	
		069UF1B0450B		450	26.5	140	35	70	
		069UF1B0500B		500	37	195	36	72	
		069UF1B0550B		550	52	280	37.5	75	
		069UF1B0630B		630	75	390	42.5	85	
		069UF1B0800B		800	140	800	52.5	105	

Notes: Minimum operating voltage for integrated trip indicator = 20V
Microswitch reference : MS 3V 1-5

Size	Voltage	Ref:		Current rating I_N (A)	Pre-arcing $I^2t @ 1 \text{ ms}$ I^2t_p (kA ² s)	Total Clearing $I^2t @ U_N$ (kA ² s)	Watt Losses		Tested Interrupting rating
							$0.8I_N$	I_N	
2	690V	069UF2B0400B		400	15	80	32.5	75	200kA @660V (IEC) 170kA @700V (USA)
		069UF2B0450B		450	20	115	40	80	
		069UF2B0500B		500	28	145	45	90	
		069UF2B0550B		550	37	195	47.5	95	
		069UF2B0630B		630	54	280	52.5	105	
		069UF2B0700B		700	76	400	55	110	
		069UF2B0800B		800	115	600	60	120	
		069UF2B0900B		900	170	900	62.5	125	

Notes: Minimum operating voltage for integrated trip indicator = 20V
Microswitch reference : MS 3V 1-5

Main Characteristics continued.....

Size	Voltage	Ref:		Current rating I _N (A)	Pre-arcing I ² t @ 1 ms I ² t _p (kA ² s)	Total Clearing I ² t @ U _N (kA ² s)	Watt Losses		Tested Interrupting rating
							0.8I _N	I _N	
3	690V	069UF3B0500B		500	19	100	52.5	105	200kA @660V (IEC) 170kA @700V (USA)
		069UF3B0550B		550	27	140	55	110	
		069UF3B0630B		630	40	210	60	120	
		069UF3B0700B		700	55	300	62.5	125	
		069UF3B0800B		800	95	490	65	130	
		069UF3B0900B		900	135	700	67.5	135	
		069UF3B1000B		1000	170	900	77.5	155	
		069UF3B1100B		1100	240	1260	80	160	
		069UF3B1250B		1250	350	1850	90	180	
		069UF3B1400B		1400	480	2500	100	200	

Notes: Minimum operating voltage for integrated trip indicator = 20V
 Microswitch reference : MS 3V 1-5

Electrical Characteristics:

Times vs current characteristics

The curves shown on page 4 indicate the pre-arcing time for each rated current as a function of RMS value of pre-arcing current I:

- Tolerances on this current ± 8%
- Beyond 30 sec or 10 sec, small overloads must be eliminated by another device.

Curve CC' represents the maximum times taken by the associated device to clear small overloads; only its horizontal line is represented.

Its oblique line must be plotted according to sketch in top right corner:

- The intersection of the fuse and CC' curves indicates the minimum breaking current I_{pm} of the fuse.

Times vs current characteristics

Size 0

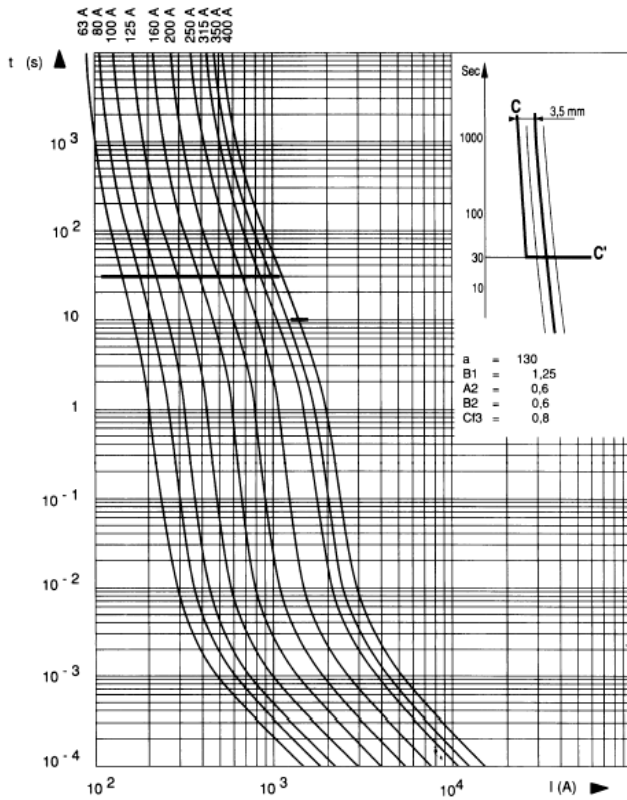

Size 1

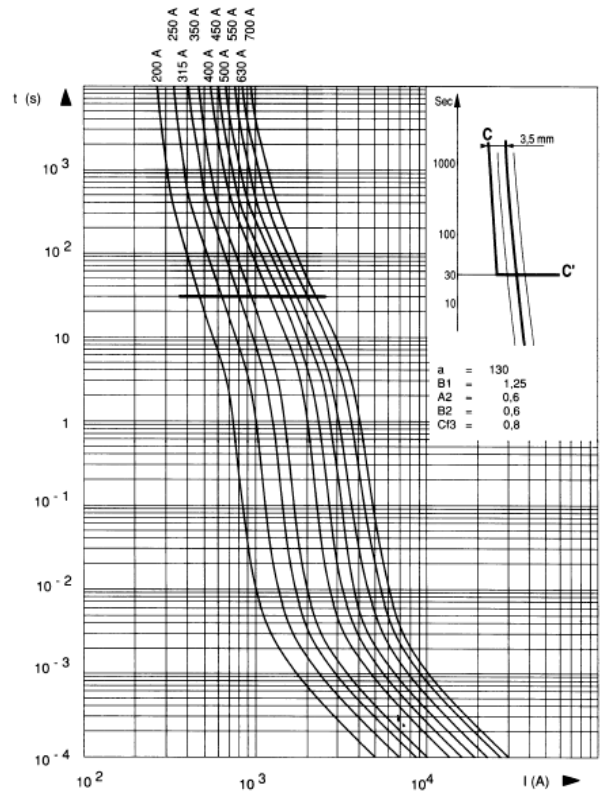

Size 2

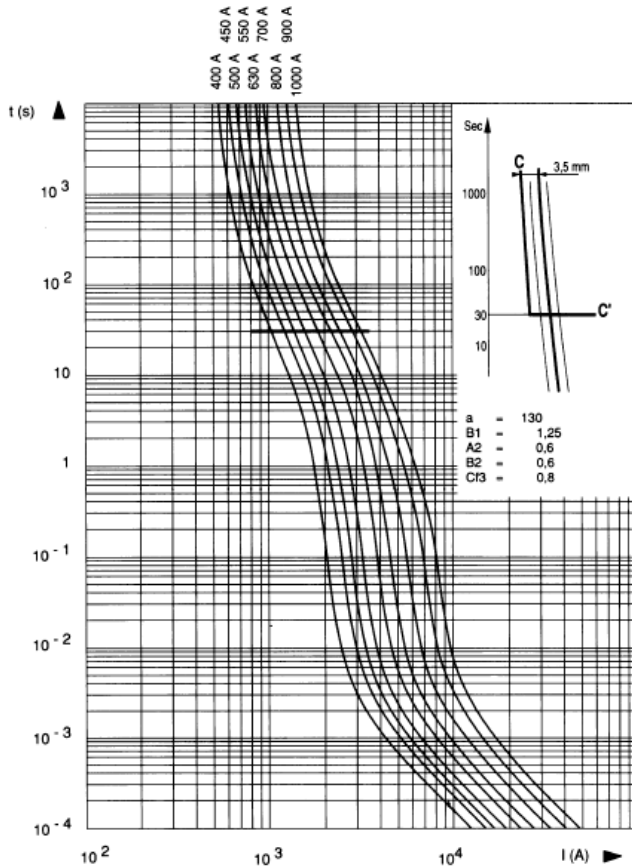

Size 3

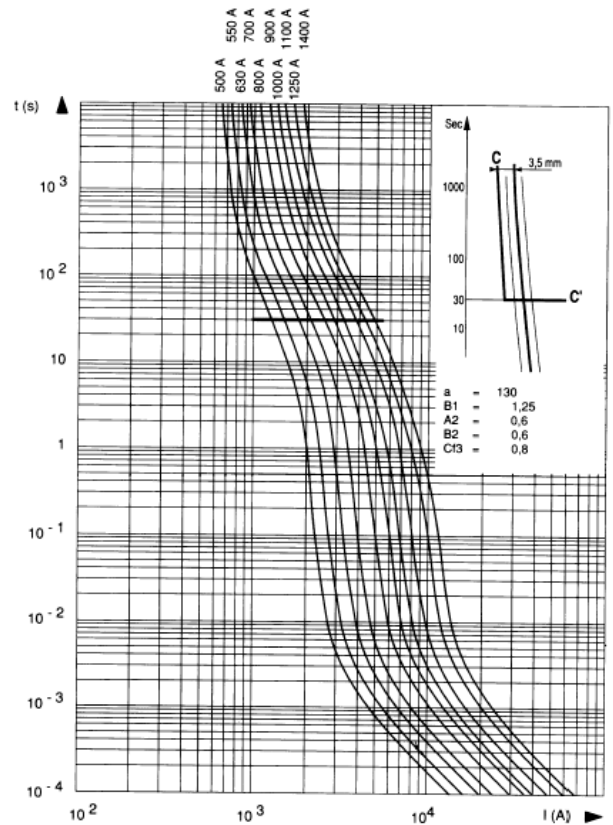

Total clearing I²T:

The horizontal curves given below indicated the maximum values of total operating I²t (I²t_t) as a function of prospective current I_p @ 660V, cosφ = 0.15. Oblique lines indicate the corresponding total operating time T_t, with pre-arcing time in brackets.

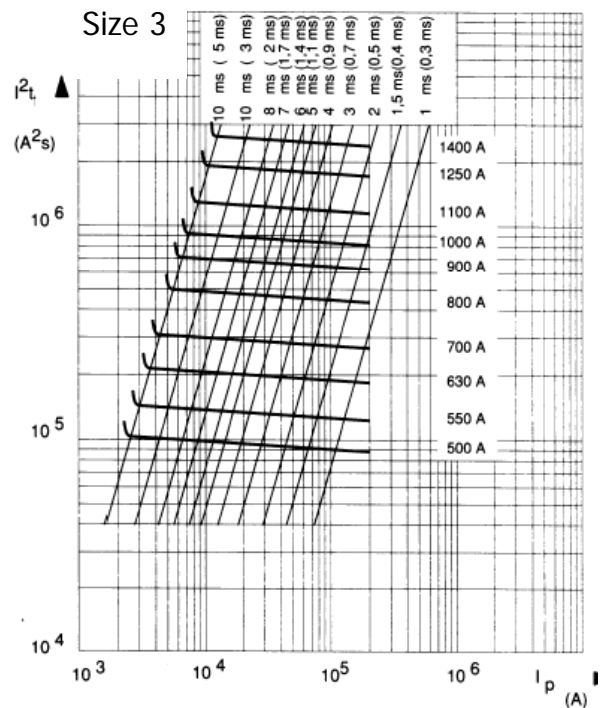
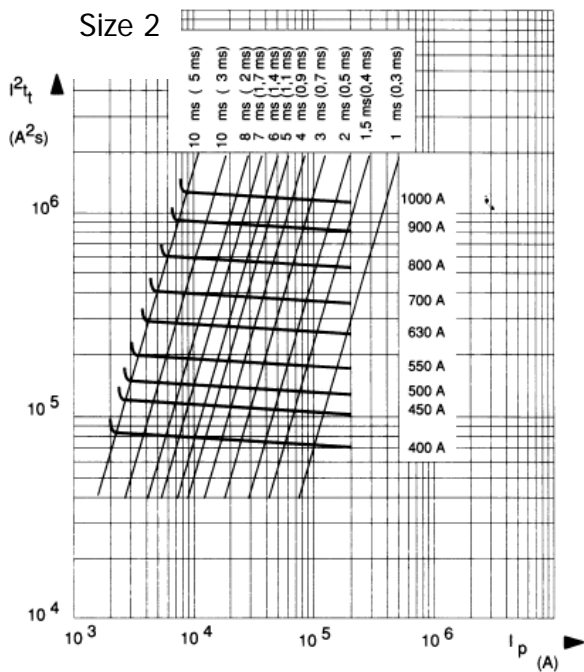
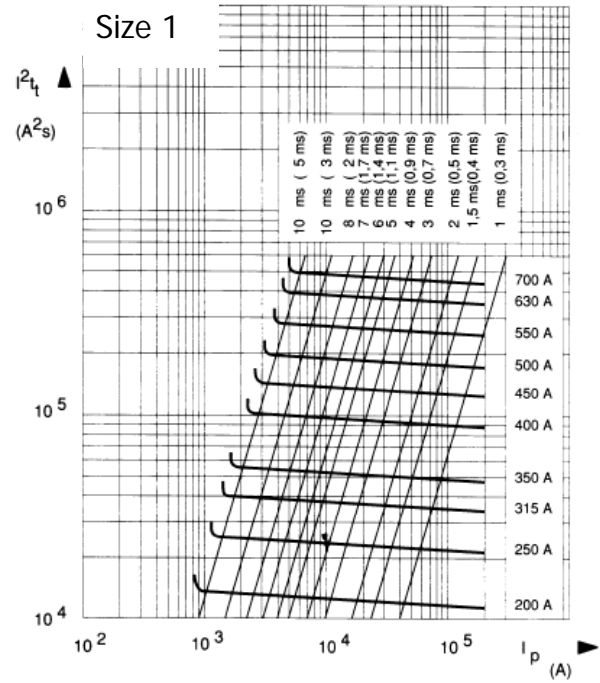
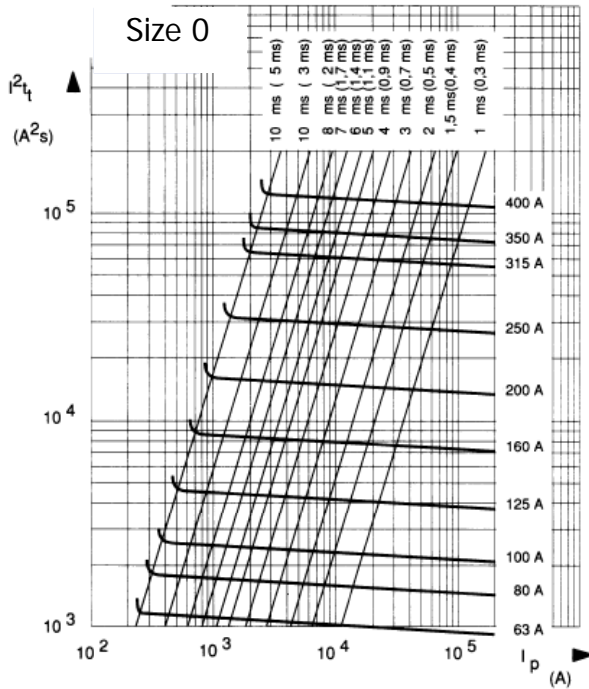

Cut off Characteristics:

The curves below indicate, for each rated current, the peak value I_c that the current may reach as a function of the prospective fault current I_p .

Size 0

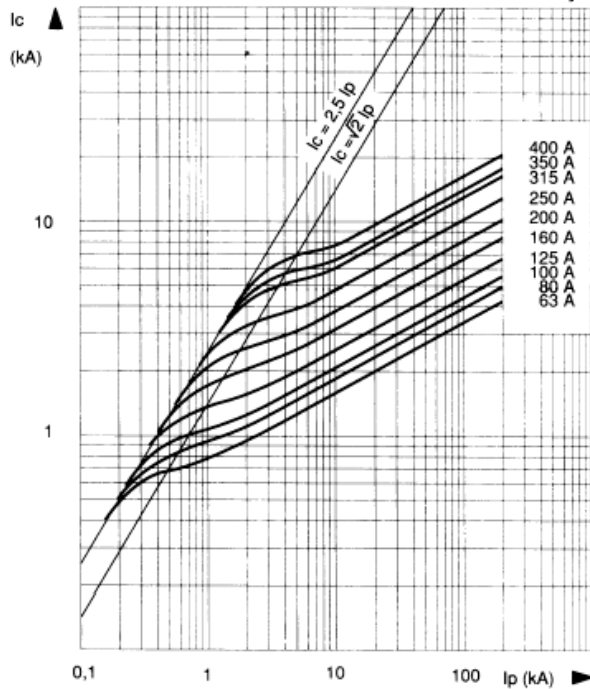

Size 1

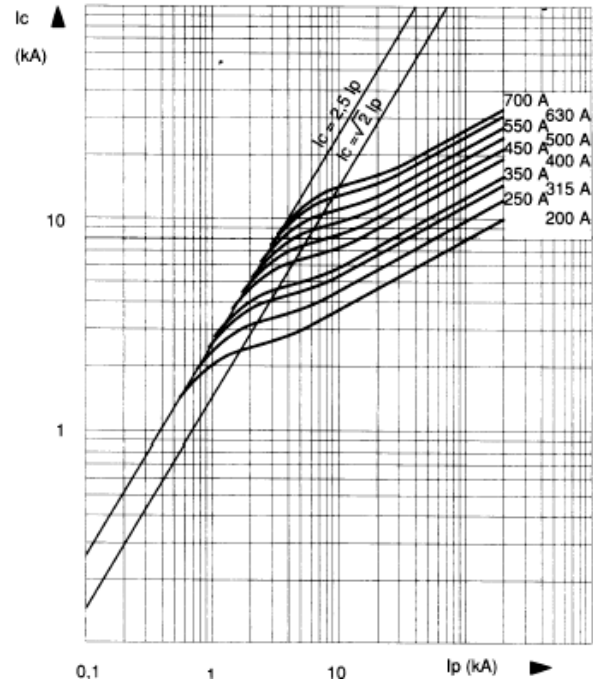

Size 2

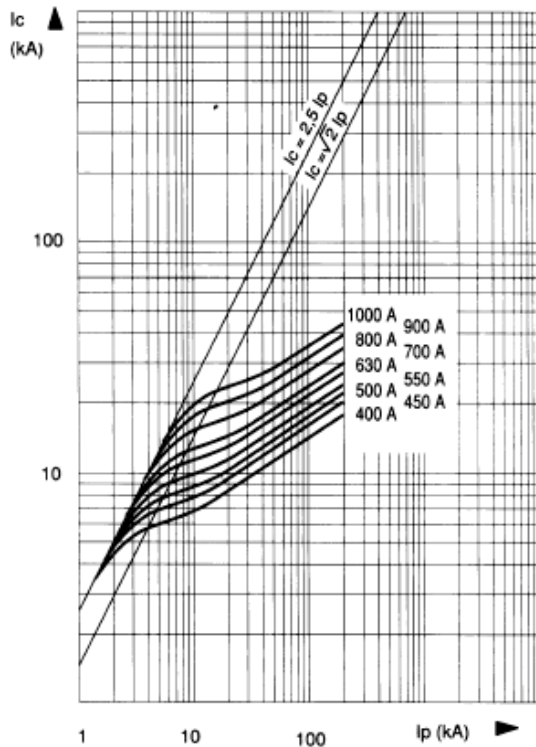

Size 3

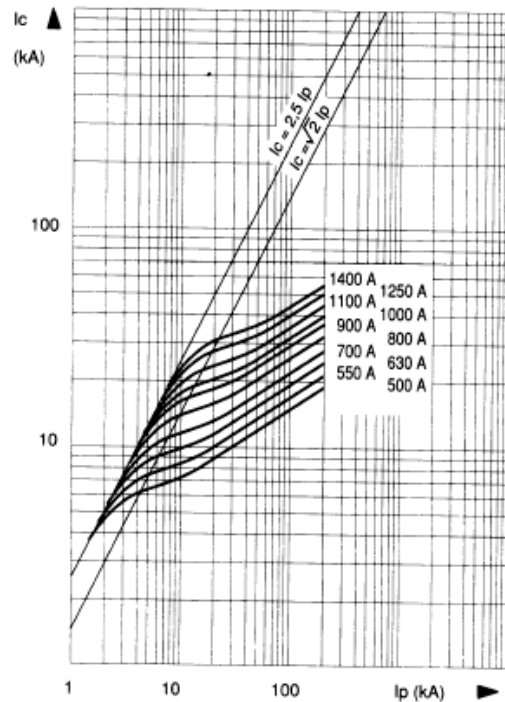

I²t Multiplier Coefficient

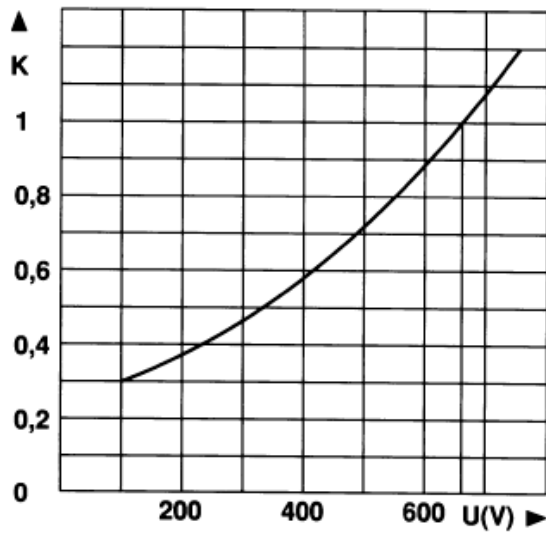

The above Mean curve shows variation of total clearing time (I^2t_c) and total operating time T_i in accordance with working voltage U.

Peak Arc Voltage

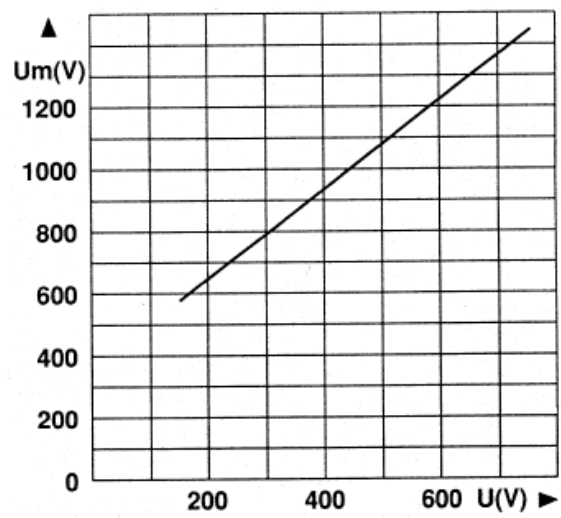

Curve indicating peak arc voltage U_m which may appear across fuse terminals as a function of working voltage U @ $\cos \varphi = 0.15$.

Dissipated Power

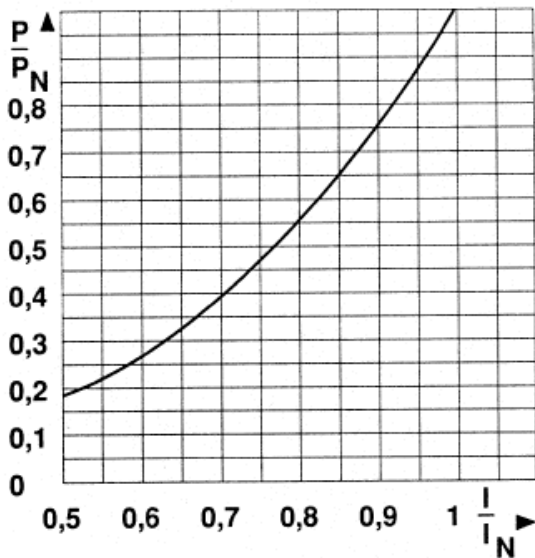

Curve enabling calculation of dissipated power P by a fuse rated I_N , as a function of the RMS current I, in multiples of I_N in a steady state.

Outline Drawing & Ordering Information:

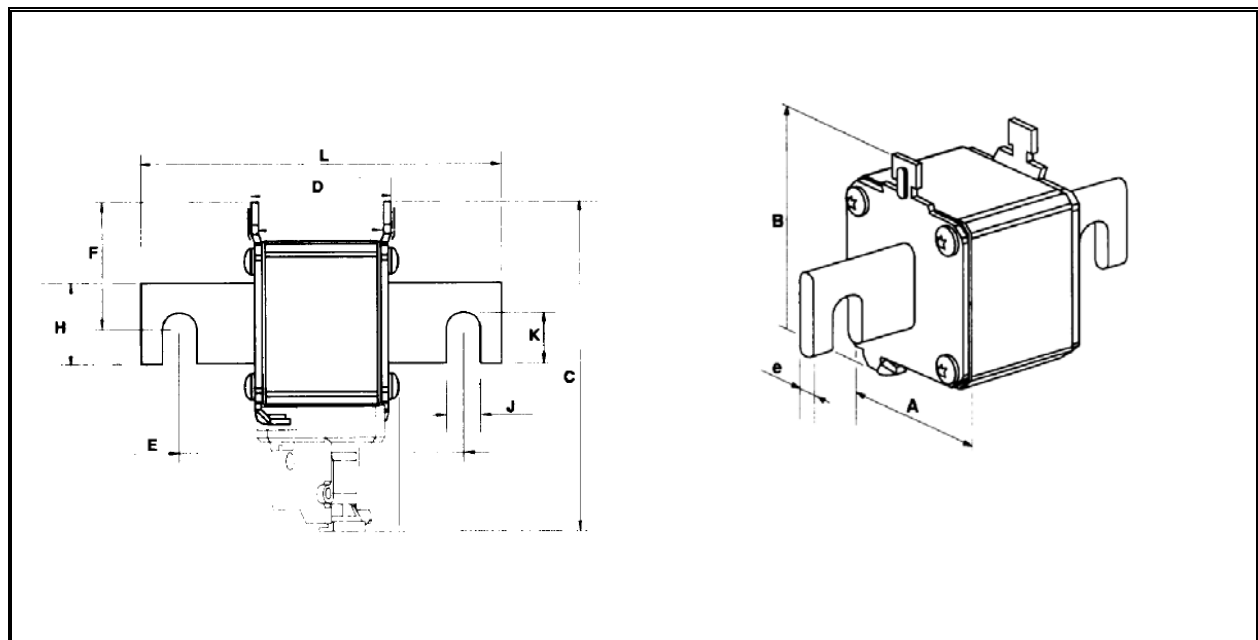

Dimensions (mm)

Size	A	B	C	D	E	L	F	H	J	K	e	Weight
0	40	62	96	44.6	76.6	100	38	18	9	11	6	290g
1	51	69	103	44.6	86.6	110	39	25	10.5	16	6	430g
2	60	78	112	44.6	91	126	43	32	13	21.2	6	590g
3	74.5	92.5	127	44.6	91	126	57	40	13	19.5	6	860g

ORDERING INFORMATION

(Please quote code as below)

Voltage Rating (V)	Type	Sizes	Fixing	Current Ratings	Indicator
690	UF	0, 1, 2, 3	A or B	0063 – 1400	B

Order code: e.g. **069UF3B0315B** = 690V, French Standard Blade, Size 3, 90mm, 315A with button indicator

IXYS Semiconductor GmbH
 Edisonstraße 15
 D-68623 Lampertheim
 Tel: +49 6206 503-0
 Fax: +49 6206 503-627
 E-mail: marcom@ixys.de



An IXYS Company

Westcode Semiconductors Ltd
 Langley Park Way Langley Park
 Chippenham Wiltshire SN15 1GE
 Tel: +44 (0)1249 444524
 Fax: +44 (0)1249 659448
 E-mail: WSL.sales@westcode.com

IXYS Corporation
 3540 Bassett Street
 Santa Clara CA 95054 USA
 Tel: +1 (408) 982 0700
 Fax: +1 (408) 496 0670
 E-mail: sales@ixys.com

www.westcode.com

www.ixys.com

Westcode Semiconductors Inc
 3270 Cherry Avenue
 Long Beach CA 90807 USA
 Tel: +1 (562) 595 6971
 Fax: +1 (562) 595 8182
 E-mail: WSI.sales@westcode.com

The information contained herein is confidential and is protected by Copyright. The information may not be used or disclosed except with the written permission of and in the manner permitted by the proprietors Westcode Semiconductors Ltd.

© Westcode Semiconductors Ltd.

In the interest of product improvement, Westcode reserves the right to change specifications at any time without prior notice.