

Filter connectors

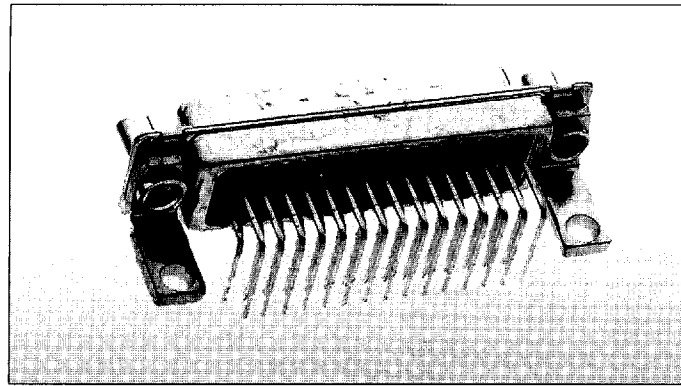

•314 inch

Solder pin angled high density with threaded lock and metal bracket

Socket connector

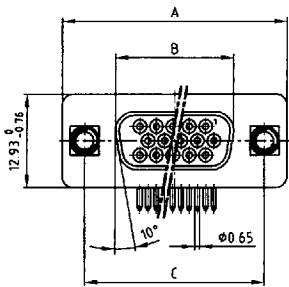

Plug connector

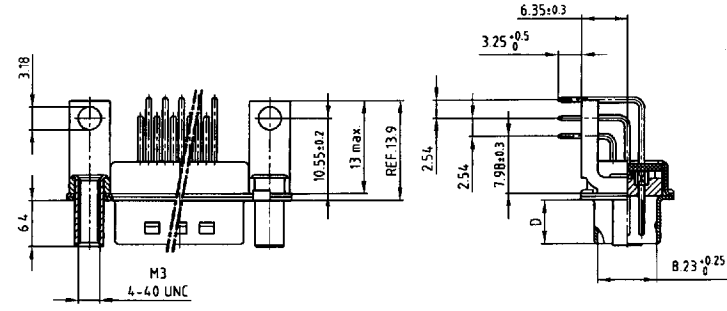
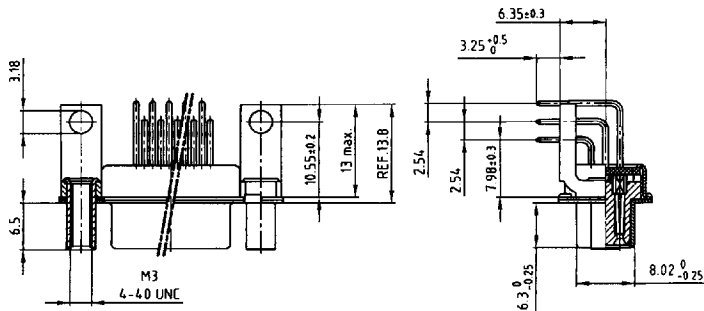
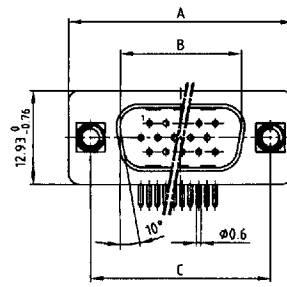

Kat 1 | R4A

No. of pos.	A - 0.76	B - 0.25	C
15	31,19	16,46	25,00 ± 0.13
26	39,52	24,79	33,30 ± 0.15
44	53,42	38,50	47,04 ± 0.13
62	69,70	54,96	63,50 ± 0.13

Kat 1 | R5A

No. of pos.	A - 0.76	B ± 0.25	C	D - 0.30
15	31,19	16,79	25,00 ± 0.13	6,12
26	39,52	25,12	33,30 ± 0.15	6,12
44	53,42	38,84	47,04 ± 0.13	5,99
62	69,70	55,30	63,50 ± 0.13	5,99

Part numbers

No. of Pos.	Socket connector high density – Solder pin angled	
	Typ 3	Typ 4
15	242 A 21800 X	242 A 21840 X
26	242 A 21810 X	242 A 21850 X
44	242 A 21820 X	242 A 21860 X
62*	242 A 21830 X	242 A 21870 X
15	242 A 21880 X	242 A 21920 X
26	242 A 21890 X	242 A 21930 X
44	242 A 21900 X	242 A 21940 X
62*	242 A 21910 X	242 A 21950 X

No. of Pos.	Plug connector high density – Solder pin angled	
	Typ 3	Typ 4
15	241 A 22100 X	241 A 22140 X
26	241 A 22110 X	241 A 22150 X
44	241 A 22120 X	241 A 22160 X
62*	241 A 22130 X	241 A 22170 X
15	241 A 22180 X	241 A 22220 X
26	241 A 22190 X	241 A 22230 X
44	241 A 22200 X	241 A 22240 X
62*	241 A 22210 X	241 A 22250 X

Filter connectors

Part number

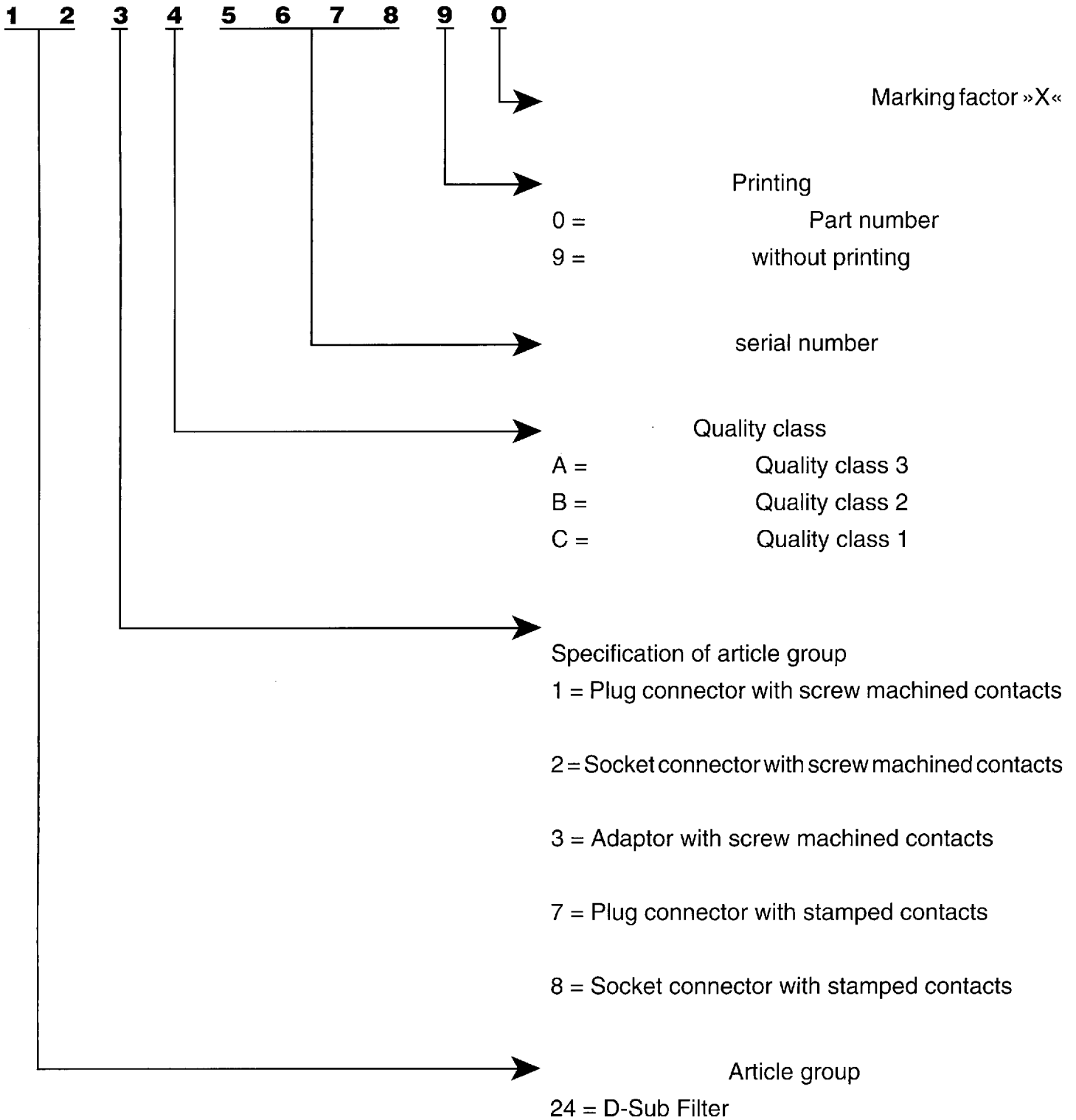

Order example

Plug connector solder pin angled 25 pos.		
Quality class	with screw machine contacts	with stamped contacts
3	241 A 12900 X	247 A 12900 X
2	241 B 12900 X	247 B 12900 X
1	241 C 12900 X	247 C 12900 X

Hole pattern for angled solder pins D-Sub filter high density

Socket connector solder pin angled

Plug connector solder pin angled

15 pos

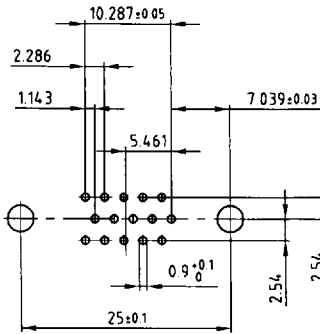

15 pos

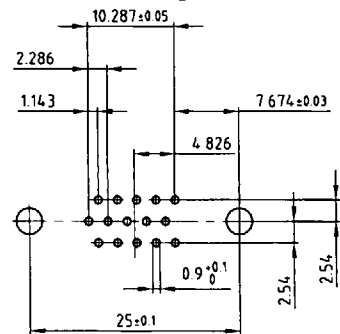

26 pos

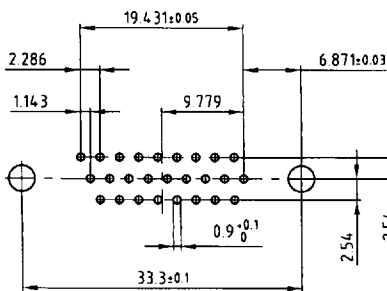

26 pos

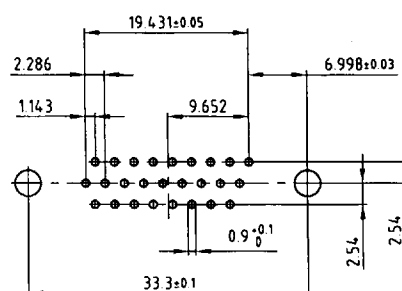

44 pos

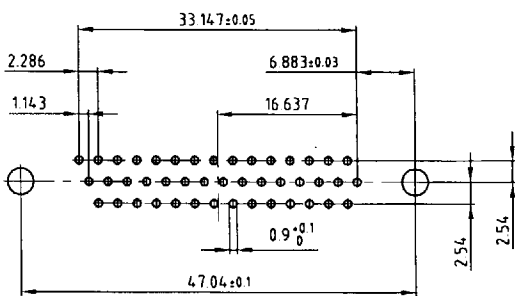

44 pos

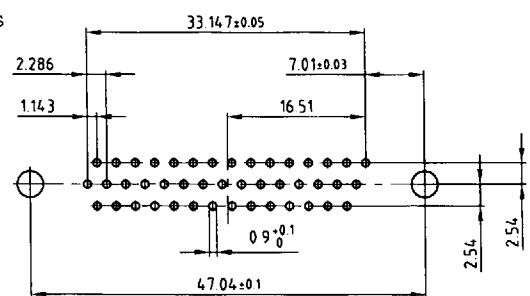

62 pos

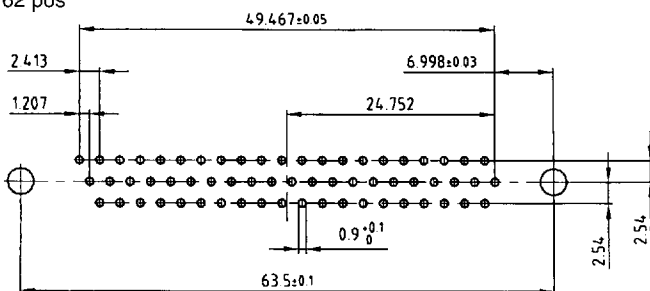

62 pos

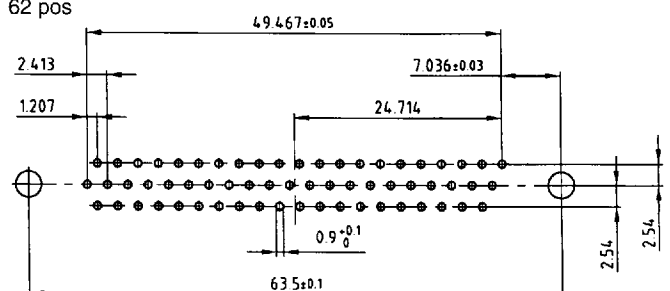

78 pos

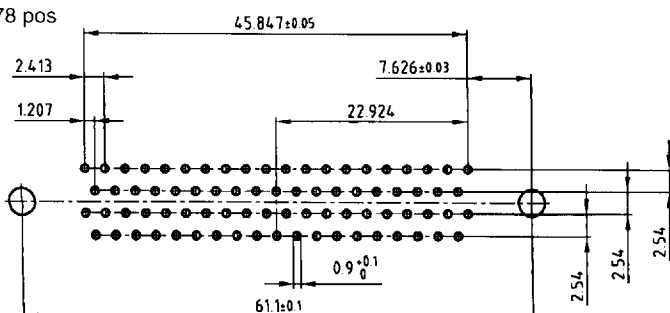

78 pos

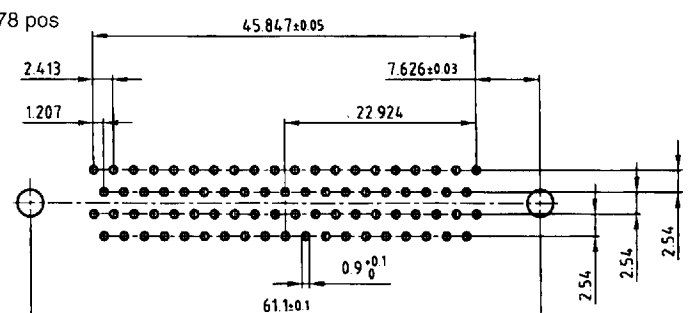

Technical Data	D-Sub Standard 9,15,25,37,50 pos.	D-Sub High Density 15,26,44,62 pos.
Insulators	Polyester GF UL 94 V-0	PA 6.6 GF 25 UL 94 V-0
Contacts	Copper alloy	
Contact finish	hard-gold-plated over nickel, solder area tin plated	
Shell	steel tin plated over nickel	
Working voltage	100 V _{DC} Insulation Gr. A according to VDE 0100 *	60 V _{DC} Insulation Gr. A according to VDE 0100 *
Dielectric stand. voltage	424 V _{DC} standard 707 V _{DC} „high voltage“	424 V _{DC}
Contact resistance	max. 10mΩ with no load Δ R max. 10 mΩ with load according to din 41652 part. 2	
Insulation resistance	depending on quality class 1 ≥ 10 ¹² Ω 2 ≥ 10 ¹¹ Ω 3 ≥ 10 ⁸ Ω	
Current rating	straight version: 5,0 A (20° C) angled version: 2,5 A (20° C)	straight version: 3,0 A (20° C) angled version: 2,5 A (20° C)
Voltage surge 10/750 μs	300 V standard 500 V „high voltage“	300 V standard
Mating-/ unmating forces	9-pol. ≤ 30/29 N 15-pol. ≤ 50/33 N 25-pol. ≤ 83/56 N 37-pol. ≤ 123/82 N 50-pol. ≤ 167/111 N	15-pol. ≤ 50/33 N 26-pol. ≤ 83/56 N 44-pol. ≤ 110/74 N
Temperature range storage	- 55° C /to + 125° C	
Temperature range working	- 25° C /to + 105° C	- 25° C /to + 85° C
Humidity	40° C / 85% relative	
Capacitor values	/type 1 min. 144 pF max. 216 pF /type 2 min. 240 pF max. 360 pF /type 3 min. 296 pF max. 444 pF /type 4 min. 664 pF max. 996 pF /type 5 min. 1040 pF max. 1560 pF	/type 3 min. 296 pF max. 444 pF /type 4 min. 664 pF max. 996 pF
Quality class	/Quality class 3 = 50 mating cycles /Quality class 2 = 200 mating cycles /Quality class 1 = 500 mating cycles	