

# SLOTTED OPTICAL SWITCHES PHOTOTRANSISTOR OUTPUT

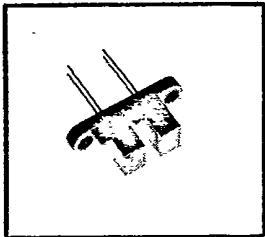

Optek Technology, Inc.  
345 Industrial Blvd.  
McKinney, Texas 75069  
(214) 542-9461

## KT 860/870/880/890 SERIES



PACKAGE T

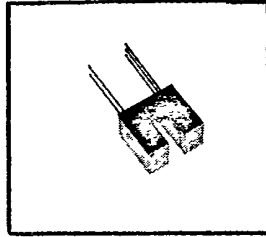

PACKAGE N

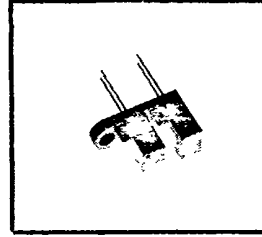

PACKAGE L

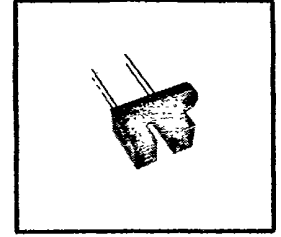

PACKAGE P

### DESCRIPTION

The KT860/KT870 series of slotted optical switches provides the design engineer with the flexibility of a custom device from a standard product line. Building from a standard housing of .125" wide slot, the user can specify (1) Electrical output parameters, (2) Mounting tab configuration, (3) Lead spacing, (4) Discrete shell, and (5) Aperture widths.

All housings are an opaque grade of injection-molded polysulfone (P1700-935) to minimize the assembly's sensitivity to ambient radiation, both visible and near-infrared. Discrete shells (exposed only on the parallel faces inside the device throat) are either IR transmissive polysulfone (P1700-1615) for applications where aperture contamination may occur, or opaque polysulfone where maximum protection against ambient radiation is a concern.

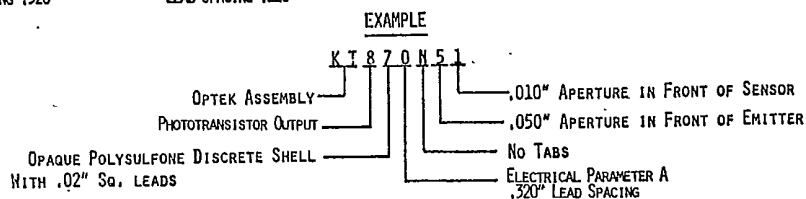
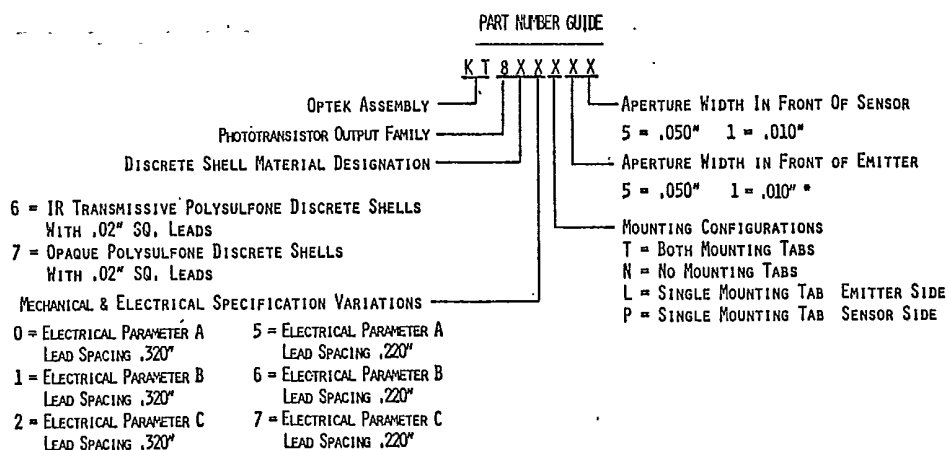

\* ASSEMBLIES WITH DUAL .010" APERTURES ARE CURRENTLY AVAILABLE WITH ELECTRICAL PARAMETER "A" ONLY.

REVISED NOVEMBER 1986

## PACKAGE T

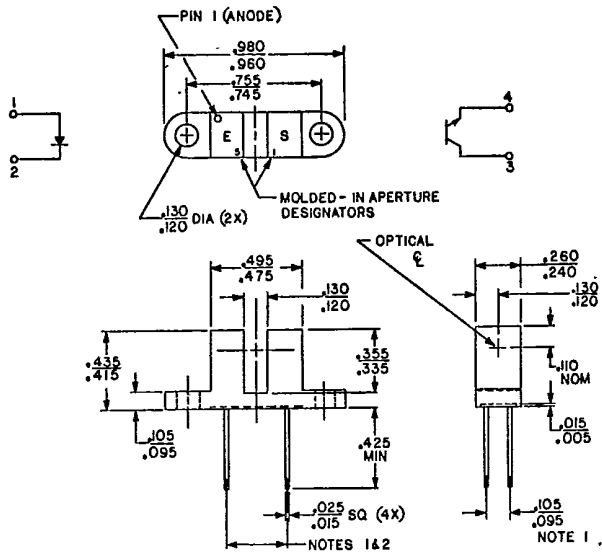

## PACKAGE N

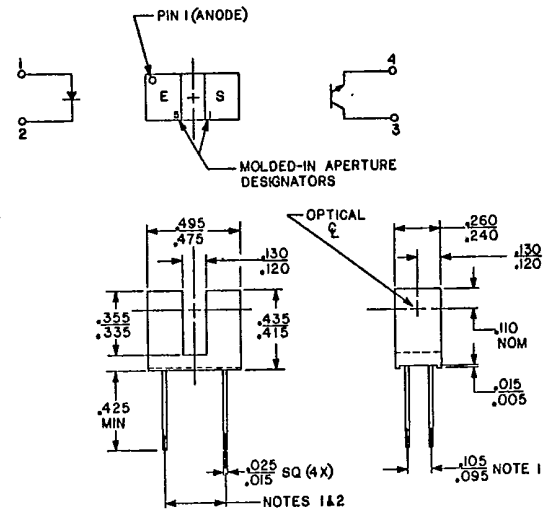

## PACKAGE L

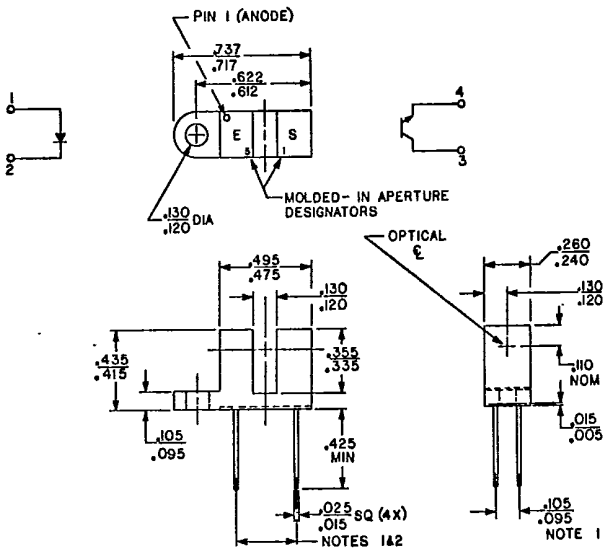

## PACKAGE P

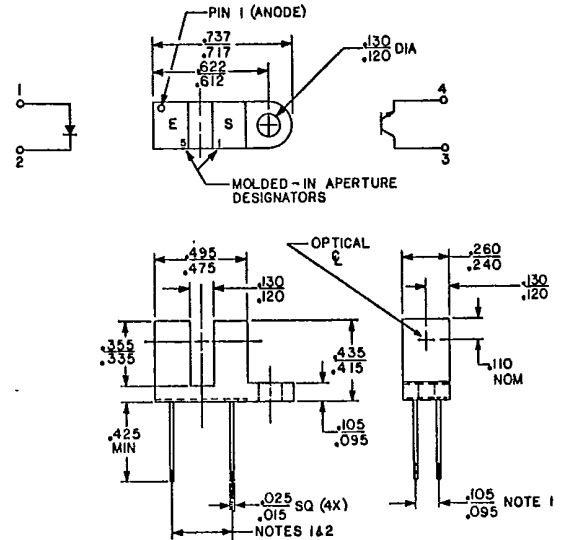

### NOTES:

1. Dimension controlled at housing surface only.
2. KT860 thru KT862 and KT870 thru KT872 lead spacing:  $.320'' \pm .005''$   
KT865 thru KT867 and KT875 thru KT877 lead spacing:  $.220'' \pm .005''$
3. Housing is soluble in chlorinated hydrocarbons and ketones. Methanol and isopropanol are recommended as cleaning agents.



# PACKAGE CONFIGURATION

## PACKAGE T

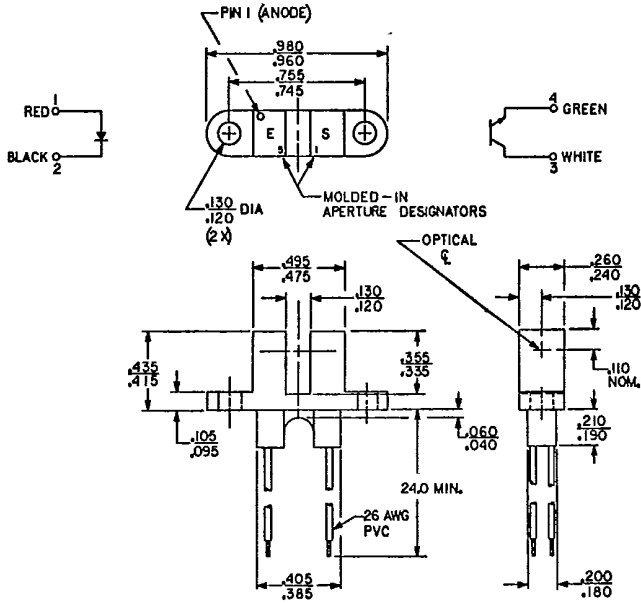

## PACKAGE N

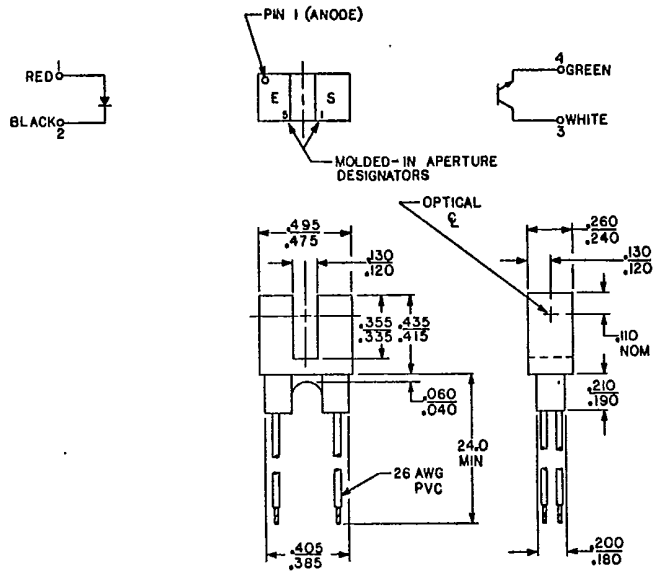

## PACKAGE L

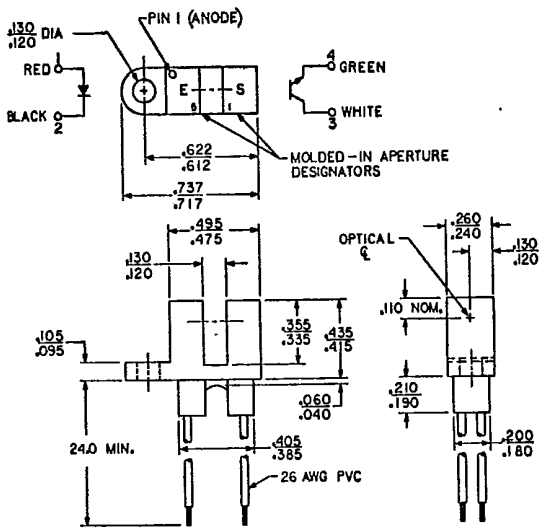

## PACKAGE P

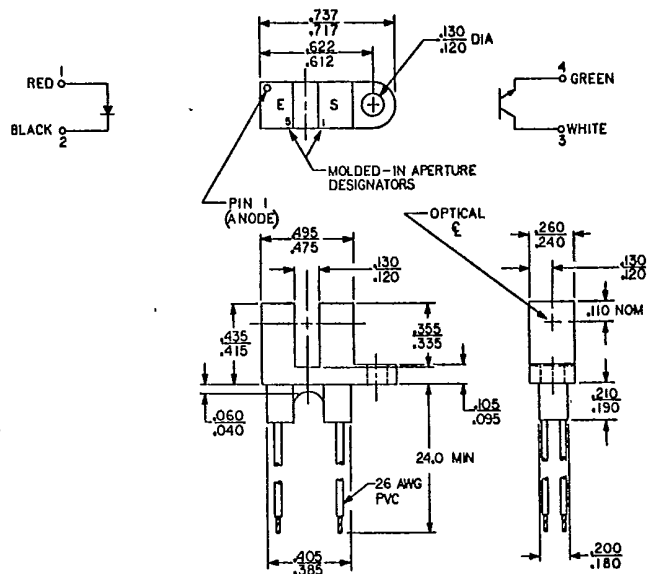

4

**TYPES KT860/KT870/KT880/KT890 SERIES**

ELECTRICAL CHARACTERISTICS (25°C UNLESS OTHERWISE NOTED)

SYMBOL	PARAMETER	MIN	MAX	UNITS	TEST CONDITIONS
<b>INPUT DIODE</b>					
$V_F$	FORWARD VOLTAGE		1.7	V	$I_F = 20 \text{ mA}$
$I_R$	REVERSE CURRENT		100	$\mu\text{A}$	$V_R = 3 \text{ V}$
<b>OUTPUT PHOTOTRANSISTOR</b>					
$V_{(BR)CEO}$	COLLECTOR-EMITTER BREAKDOWN VOLTAGE	30		V	$I_C = 1 \text{ mA}$
$V_{(BR)ECO}$	EMITTER-COLLECTOR BREAKDOWN VOLTAGE	5		V	$I_E = 100 \text{ }\mu\text{A}$
$I_{CEO}$	COLLECTOR-EMITTER DARK CURRENT		100	nA	$V_{CE} = 10 \text{ V}$
<b>COUPLED</b>					
$V_{CE(SAT)}$	COLLECTOR-EMITTER SATURATION VOLTAGE PARAMETER A-KT860,KT865,KT870,KT875, KT880,KT890		0.4	V	$I_C = 400 \text{ }\mu\text{A}, I_F = 20 \text{ mA}$
	PARAMETER B-KT861,KT866,KT871,KT876, KT881,KT891		0.4	V	$I_C = 800 \text{ }\mu\text{A}, I_F = 10 \text{ mA}$
	PARAMETER C-KT862,KT867,KT872,KT877, KT882,KT892		0.6	V	$I_C = 1800 \text{ }\mu\text{A}, I_F = 20 \text{ mA}$
$I_C(ON)$	ON-STATE COLLECTOR CURRENT PARAMETER A-KT860,KT865,KT870,KT875, KT880,KT890	500		$\mu\text{A}$	$V_{CE} = 10 \text{ V}, I_F = 20 \text{ mA}$
	PARAMETER B-KT861,KT866,KT871,KT876, KT881,KT891	1000		$\mu\text{A}$	$V_{CE} = 5 \text{ V}, I_F = 10 \text{ mA}$
	PARAMETER C-KT862,KT867,KT872,KT877, KT882,KT892	1800		$\mu\text{A}$	$V_{CE} = 0.6 \text{ V}, I_F = 20 \text{ mA}$

**ABSOLUTE MAXIMUM RATINGS (25°C unless otherwise noted)**

Storage and Operating Temperature Range..... KT860/KT870 Series -40°C to +85°C (A)  
 KT880/KT890 Series -40°C to +80°C (B)  
 Lead Soldering Temperature (1/16 inch from case .....+240°C (C)  
 for 5 sec. with soldering iron)

**INPUT DIODE**

Forward DC Current.....50 mA  
 Peak Forward Current ( 1  $\mu\text{s}$  pulse width, 300pps).....3 A  
 Reverse DC Voltage.....3 V  
 Power Dissipation.....100 mW (A) (B)

**OUTPUT PHOTOTRANSISTOR**

Collector-Emitter Voltage .....30 V  
 Emitter-Collector Voltage.....5 V  
 Collector DC Current.....30 mA (A) (B)  
 Power Dissipation.....100 mW

**NOTES:** (A) Derate linearly 1.67mW/°C above 25°C

(B) Derate linearly 1.82mW/°C above 25°C (Maximum storage and operating temperature limited by temperature rating of lead wires)

(C) Applies to KT860/KT870 Series only. RMA flux is recommended. Duration can be extended to 10 sec. max. when wave soldering.

(D) All parameters tested using pulse technique.

5

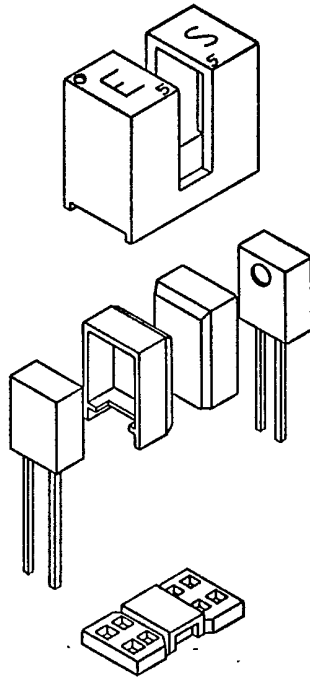

All housings are an opaque grade of injection-molded polysulfone (P1700-935) to minimize the assembly's sensitivity to ambient radiation, both visible and near-infrared. Discrete shells (exposed only on the parallel faces inside the device throat) are either IR transmissive polysulfone (P1700-1615) for applications where aperture contamination may occur, or opaque polysulfone (P1700-935) with aperture openings, where maximum protection against ambient radiation is a concern.

6

# TYPICAL PERFORMANCE CURVES

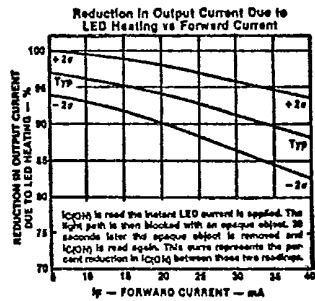
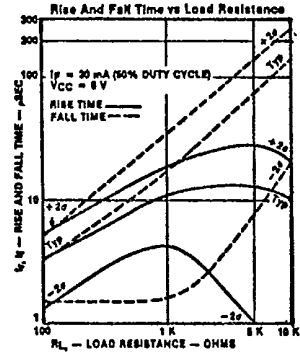
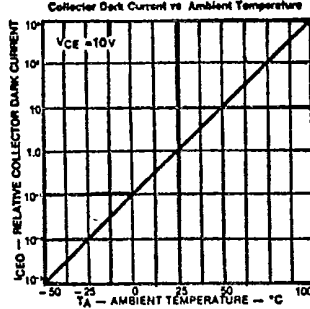
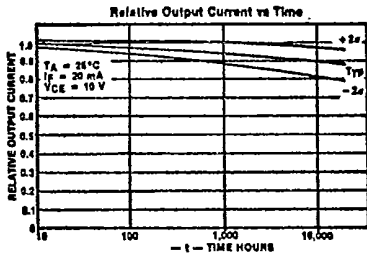
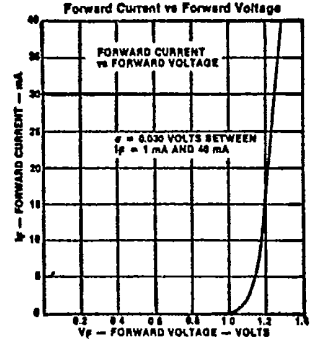
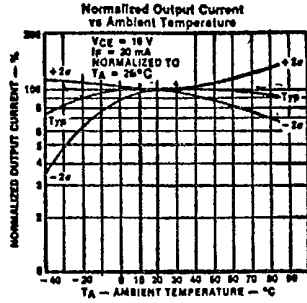
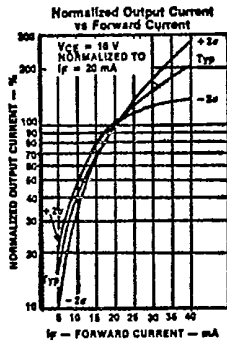

All Part Numbers Ending In "1"

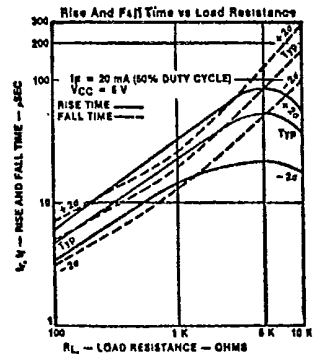
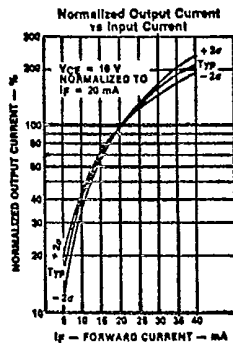

7