

# S16MD01/S16MD02 S26MD01/S26MD02

## 8-Pin DIP Type SSR for Low Power Control

### ■ Features

1. Compact 8-pin dual-in-line package type
2. RMS ON-state current  $I_T$  : 0.6Arms
3. Built-in zero-cross circuit  
(S16MD02 / S26MD02)
4. High repetitive peak OFF-state voltage  
S16MD01 / S16MD02  $V_{DRM}$  : MIN. 400V  
S26MD01 / S26MD02  $V_{DRM}$  : MIN. 600V
5. Isolation voltage between input and output  
(  $V_{iso}$  : 4,000Vrms )
6. Recognized by UL, file No. E94758
7. Approved by CSA No. LR63705

### ■ Applications

1. Oil fan heaters
2. Microwave ovens
3. Refrigerators

### ■ Model Line-ups

	For 100V lines	For 200V lines
No built-in zero-cross circuit	<b>S16MD01</b>	<b>S26MD01</b>
Built-in zero-cross circuit	<b>S16MD02</b>	<b>S26MD02</b>

### ■ Outline Dimensions

(Unit : mm )

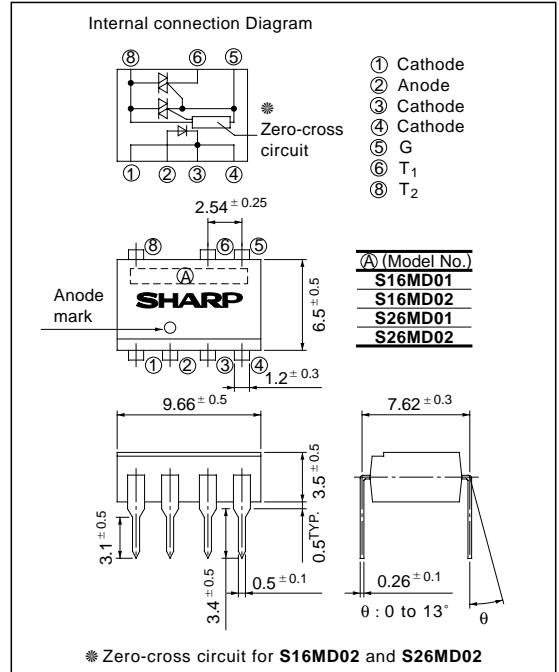

Terminal ①, ③ and ④ are common ones of cathode.  
To radiate the heat, solder all of the lead pins on the pattern of PWB.

### ■ Absolute Maximum Ratings

(Ta = 25 °C)

Parameter		Symbol	Rating	Unit
Input	Forward current	$I_F$	50	mA
	Reverse voltage	$V_R$	6	V
Output	RMS ON-state current	$I_T$	0.6	A <sub>rms</sub>
	*1 Peak one cycle surge current	$I_{surge}$	6	A
	Repetitive peak OFF-state voltage	S16MD01 / S16MD02	$V_{DRM}$	400
S26MD01 / S26MD02		600		V
*2 Isolation voltage		$V_{iso}$	4 000	V <sub>rms</sub>
Operating temperature		$T_{opr}$	- 25 to + 80	°C
Storage temperature		$T_{stg}$	- 40 to + 125	°C
*3 Soldering temperature		$T_{sol}$	260	°C

\*1 50Hz sine wave

\*2 AC for 1 minute, 40 to 60% RH, f = 60Hz

\*3 For 10 seconds

**Electrical Characteristics**

(T<sub>a</sub> = 25°C)

Parameter		Symbol	Conditions	MIN.	TYP.	MAX.	Unit
Input	Forward voltage	V <sub>F</sub>	I <sub>F</sub> = 20mA	-	1.2	1.4	V
	Reverse current	I <sub>R</sub>	V <sub>R</sub> = 3V	-	-	10	μA
Output	Repetitive peak OFF-state current	I <sub>DRM</sub>	V <sub>DRM</sub> = Rated	-	-	100	μA
	ON-state voltage	V <sub>T</sub>	I <sub>T</sub> = 0.6A	-	-	3.0	V
	Holding current	I <sub>H</sub>	V <sub>D</sub> = 6V	-	-	25	mA
	Critical rate of rise of OFF-state voltage	dV/dt	V <sub>DRM</sub> = (1/√2) • Rated	100	-	-	V/μs
	Zero-cross voltage	V <sub>OX</sub>	Resistance load I <sub>F</sub> = 15mA	-	-	35	V
	<b>S16MD02</b> <b>S26MD02</b>						
Transfer characteristics	Minimum trigger current	I <sub>FT</sub>	V <sub>D</sub> = 6V, R <sub>L</sub> = 100Ω	-	-	10	mA
	Isolation resistance	R <sub>ISO</sub>	DC500V, 40 to 60% RH	5 x 10 <sup>10</sup>	10 <sup>11</sup>	-	Ω
	Turn-on time	t <sub>on</sub>	V <sub>D</sub> = 6V, R <sub>L</sub> = 100Ω I <sub>F</sub> = 20mA	-	-	100	μs
				<b>S16MD02</b> <b>S26MD02</b>	-	-	50

**Fig. 1 RMS ON-state Current vs. Ambient Temperature**

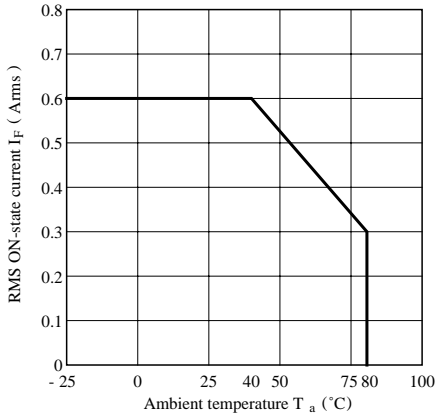

**Fig. 2 Forward Current vs. Ambient Temperature**

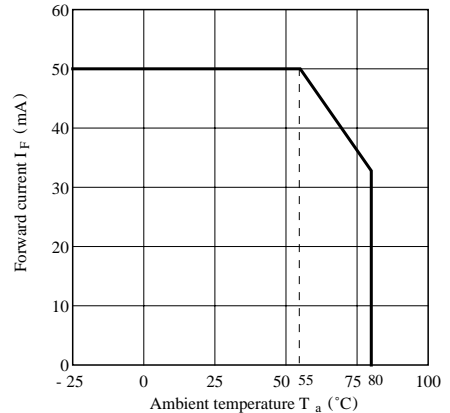

**Fig. 3 Forward Current vs. Forward Voltage**

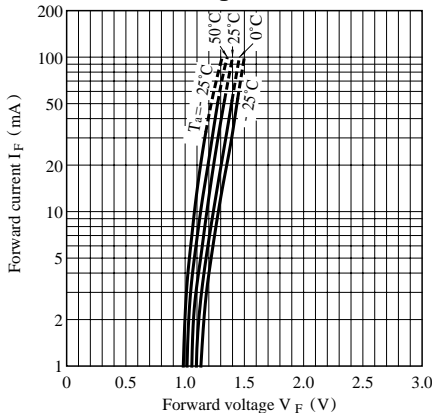

**Fig. 4 Minimum Trigger Current vs. Ambient Temperature (S16MD01/S16MD02)**

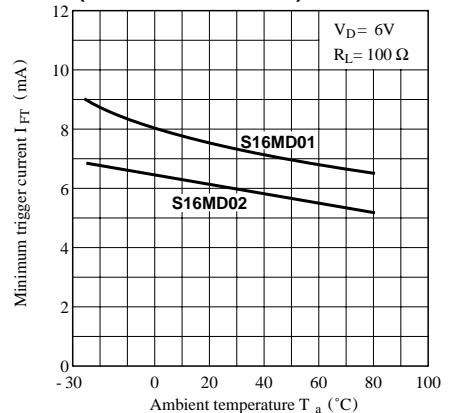

**Fig. 5 Minimum Trigger Current vs. Ambient Temperature (S26MD01/ S26MD02)**

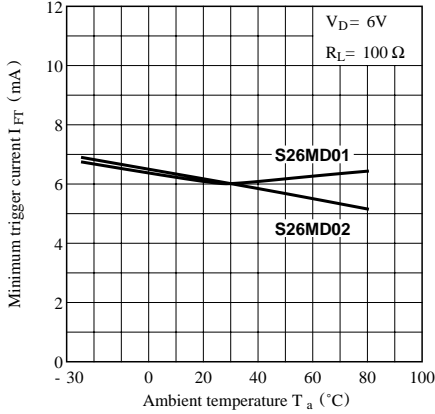

**Fig. 6 ON-state Voltage vs. Ambient Temperature**

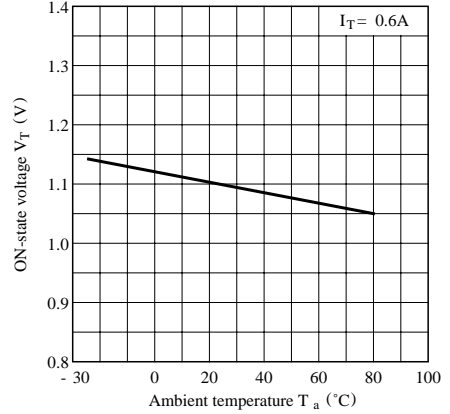

**Fig. 7 Relative Holding Current vs. Ambient Temperature**

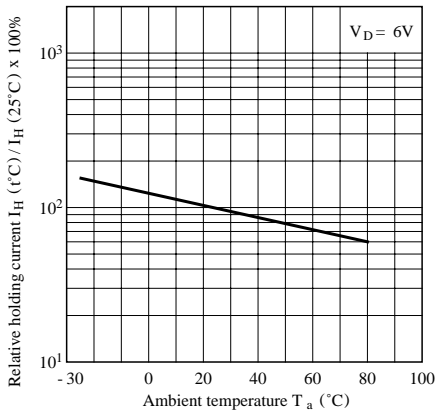

**Fig. 8 ON-state Current vs. ON-state Voltage**

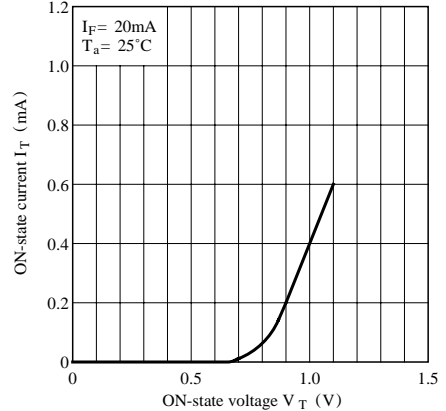

**Fig. 9 Turn-on Time vs. Forward Current (S16MD01)**

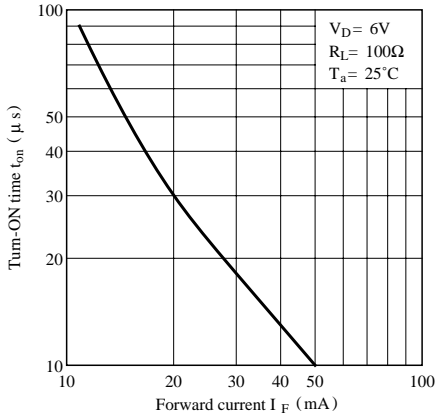

**Fig.10 Turn-on Time vs. Forward Current (S26MD01)**

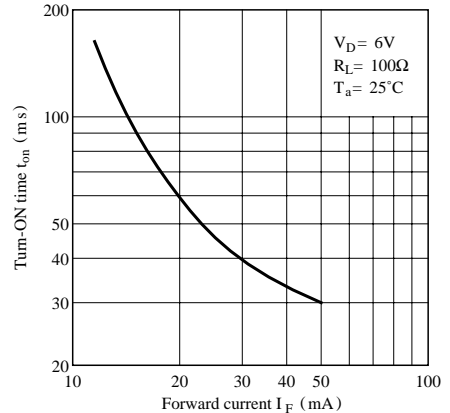

Fig.11 Turn-on Time vs. Forward Current  
(S16MD02/S26MD02)

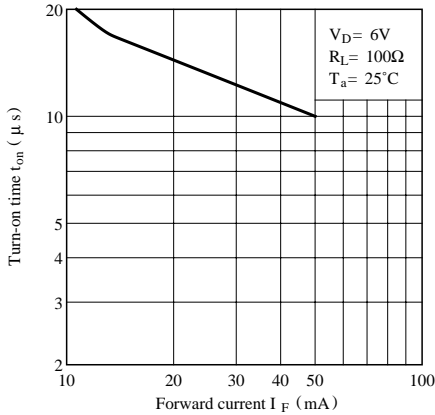
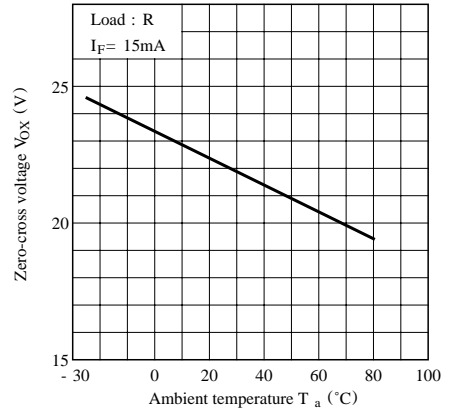
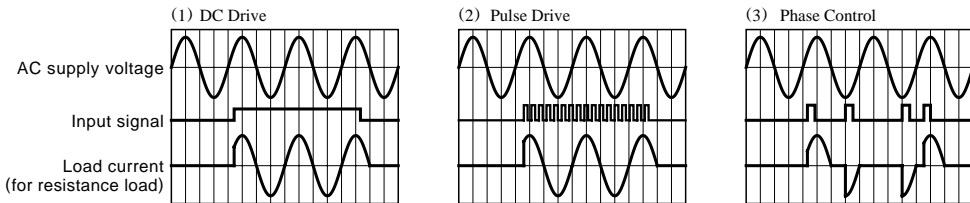
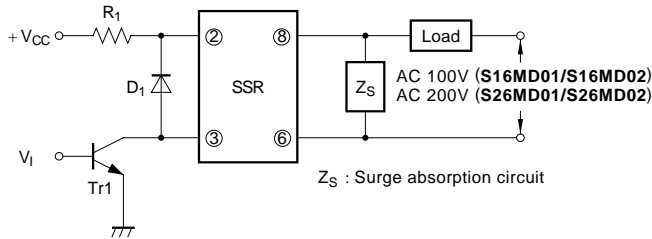

Fig.12 Zero-cross Voltage vs. Ambient Temperature  
(S16MD02/S26MD02)



## Basic Operation Circuit



- Notes 1) If large amount of surge is loaded onto  $V_{CC}$  or the driver circuit, add a diode  $D_1$  between terminal 2 and 3 to prevent reverse bias from being applied to the infrared LED.
- 2) Be sure to install a surge absorption circuit.  
An appropriate circuit must be chosen according to the load (for CR, choose its constant). This must be carefully done especially for an inductive load.
- 3) For phase control, adjust such that the load current immediately after the input signal is applied will be more than 30mA.

## Precautions for Use

- All pins must be soldered since they are also used as heat sinks (heat radiation fins). In designing, consider the heat radiation from the mounted SSR.
- For higher radiation efficiency that allows wider thermal margin, secure a wider round pattern for Pin No.8 when designing mounting pattern. The rounded part of Pin No.5 (gate) must be as small as possible. Pulling the gate pattern around increases the change of being affected by external noise.
- As for other general cautions, refer to the chapter "Precautions for Use"