

Typical Applications

- Broadband, Low-Noise Gain Blocks
- IF or RF Buffer Amplifiers
- Driver Stage for Power Amplifiers
- Final PA for Low-Power Applications
- High Reliability Applications
- Broadband Test Equipment

Product Description

The RF2044 is a general purpose, low-cost RF amplifier IC. The device is manufactured on an advanced Gallium Arsenide Heterojunction Bipolar Transistor (HBT) process, and has been designed for use as an easily-cascadable 50Ω gain block. Applications include IF and RF amplification in wireless voice and data communication products operating in frequency bands up to 6000MHz. The device is self-contained with 50Ω input and output impedances and requires only two external DC biasing elements to operate as specified. With a goal of enhanced reliability, the extremely small Micro-X ceramic package offers significantly lower thermal resistance than similar size plastic packages.

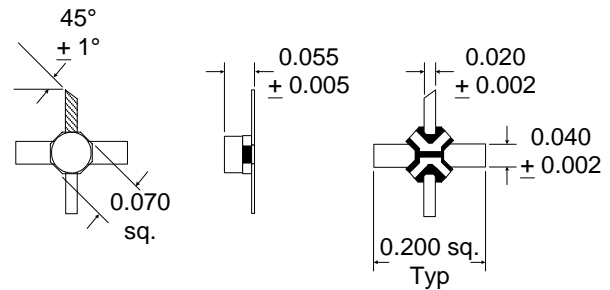

- NOTES:**
1. Shaded lead is pin 1.
 2. Darkened areas are metallization.

4
GENERAL PURPOSE AMPLIFIERS

Optimum Technology Matching® Applied

- | | | |
|-------------------------------------|--|--------------------------------------|
| <input type="checkbox"/> Si BJT | <input checked="" type="checkbox"/> GaAs HBT | <input type="checkbox"/> GaAs MESFET |
| <input type="checkbox"/> Si Bi-CMOS | <input type="checkbox"/> SiGe HBT | <input type="checkbox"/> Si CMOS |

Package Style: Micro-X Ceramic

- Features**
- DC to >6000MHz Operation
 - Internally matched Input and Output
 - 20dB Small Signal Gain
 - 4.0dB Noise Figure
 - 50mW Linear Output Power
 - Single Positive Power Supply

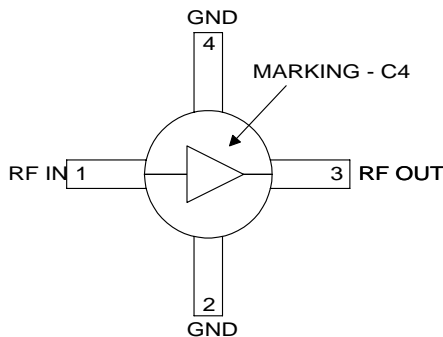

Functional Block Diagram

Ordering Information

RF2044	General Purpose Amplifier
RF204X PCBA	Fully Assembled Evaluation Board

RF Micro Devices, Inc.
7625 Thorndike Road
Greensboro, NC 27409, USA

Tel (336) 664 1233
Fax (336) 664 0454
<http://www.rfmd.com>

RF2044

Absolute Maximum Ratings

Parameter	Rating	Unit
Input RF Power	+13	dBm
Operating Ambient Temperature	-40 to +85	°C
Storage Temperature	-60 to +150	°C



Caution! ESD sensitive device.

RF Micro Devices believes the furnished information is correct and accurate at the time of this printing. However, RF Micro Devices reserves the right to make changes to its products without notice. RF Micro Devices does not assume responsibility for the use of the described product(s).

4
GENERAL PURPOSE
AMPLIFIERS

Parameter	Specification			Unit	Condition
	Min.	Typ.	Max.		
Overall					T=25 °C, I _{CC} =65mA
Frequency Range		DC to >6000		MHz	
3dB Bandwidth		3		GHz	
Gain	19.3 16.5	20.4	21.3	dB	Freq=100MHz
		20.3		dB	Freq=850MHz
		19.0		dB	Freq=2000MHz
		17.5		dB	Freq=3000MHz
		16.6			Freq=4000MHz
		14.3			Freq=6000MHz
Gain Flatness		±0.7		dB	100MHz to 2000MHz
Noise Figure		4.1		dB	Freq=1000MHz
Input VSWR		<1.4:1			In a 50Ω system, DC to 5000MHz
		<1.7:1			In a 50Ω system, 5000MHz to 6000MHz
Output VSWR		<1.2:1			In a 50Ω system, DC to 3000MHz
		<1.8:1			In a 50Ω system, 3000MHz to 6000MHz
Output IP ₃	+30.0	+33.5		dBm	Freq=1000MHz
Output P _{1dB}		+18.5		dBm	Freq=1000MHz
Reverse Isolation		22.3		dB	Freq=1000MHz
Thermal					I _{CC} =65mA, P _{DISS} =300mW
Theta _{JC}		188		°C/W	
Maximum Measured Junction Temperature at DC Bias Conditions		143		°C	T _{AMB} =+85°C
Mean Time Between Failures		1.3x10 ³		years	T _{AMB} =+85°C
		3.1x10 ⁵		years	T _{AMB} =+25°C
		1.6x10 ⁹		years	T _{AMB} =-40°C
Power Supply					With 22Ω bias resistor
Device Operating Voltage	4.3	4.8	5.3	V	At pin 3 with I _{CC} =65mA
Operating Current	60	65	80	mA	

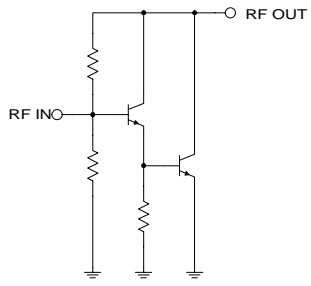
Pin	Function	Description	Interface Schematic
1	RF IN	RF input pin. This pin is NOT internally DC blocked. A DC blocking capacitor, suitable for the frequency of operation, should be used in most applications. DC coupling of the input is not allowed, because this will override the internal feedback loop and cause temperature instability.	
2	GND	Ground connection. Keep traces physically short and connect immediately to ground plane for best performance.	
3	RF OUT	RF output and bias pin. Biasing is accomplished with an external series resistor and choke inductor to V_{CC} . The resistor is selected to set the DC current into this pin to a desired level. The resistor value is determined by the following equation: $R = \frac{(V_{SUPPLY} - V_{DEVICE})}{I_{CC}}$ <p>Care should also be taken in the resistor selection to ensure that the current into the part never exceeds 90mA over the planned operating temperature. This means that a resistor between the supply and this pin is always required, even if a supply near 4.9V is available, to provide DC feedback to prevent thermal runaway. Because DC is present on this pin, a DC blocking capacitor, suitable for the frequency of operation, should be used in most applications. The supply side of the bias network should also be well bypassed.</p>	
4	GND	Same as pin 2.	

4

GENERAL PURPOSE
AMPLIFIERS

Application Schematic

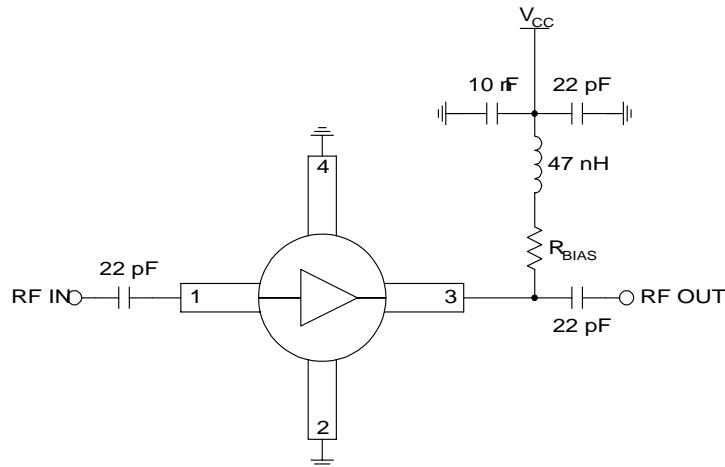

Evaluation Board Schematic

(Download [Bill of Materials](http://www.rfmd.com) from www.rfmd.com.)

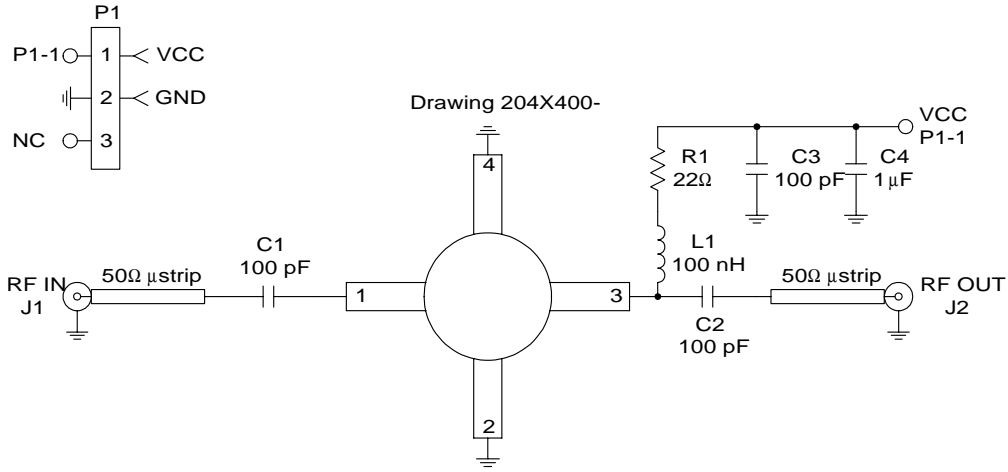

Evaluation Board Layout Board Size 1.195" x 1.000"

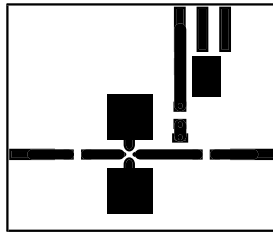
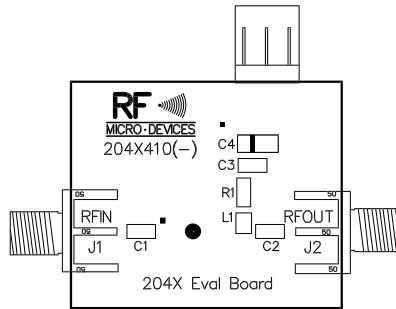

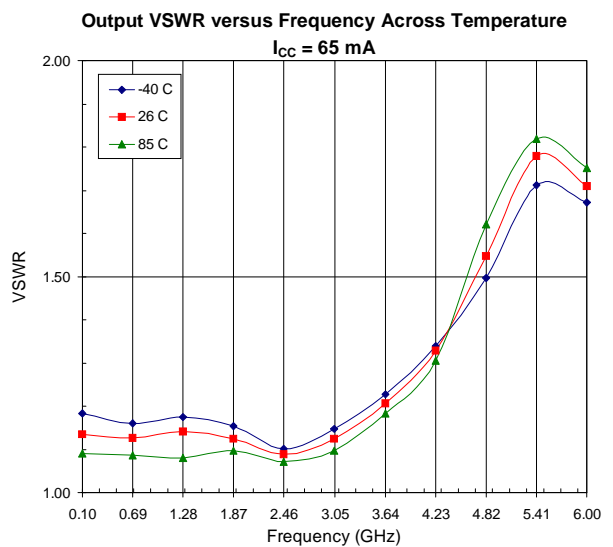
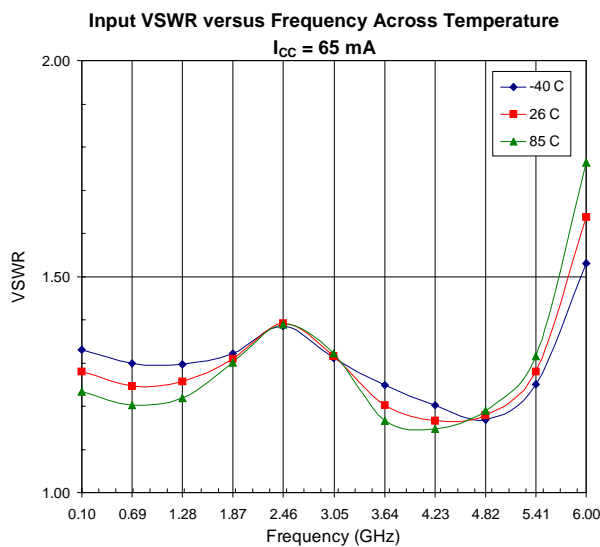
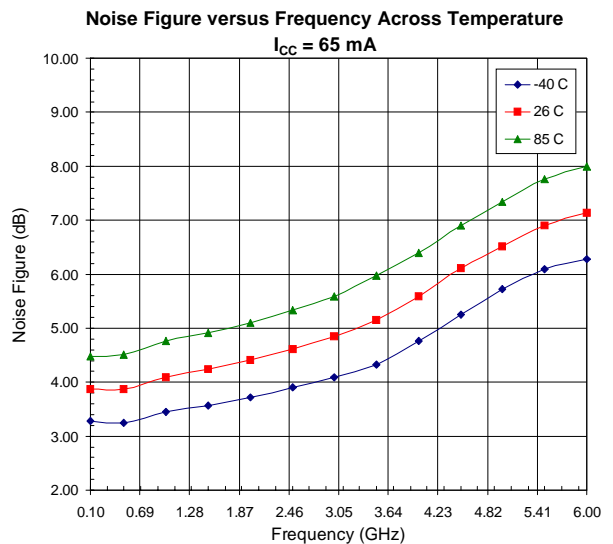
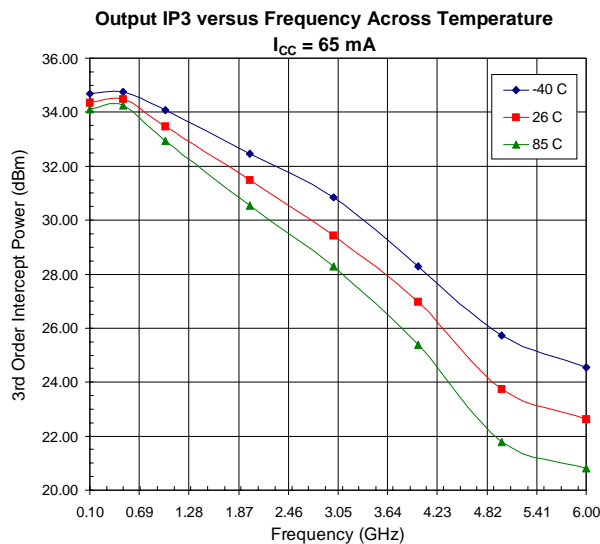
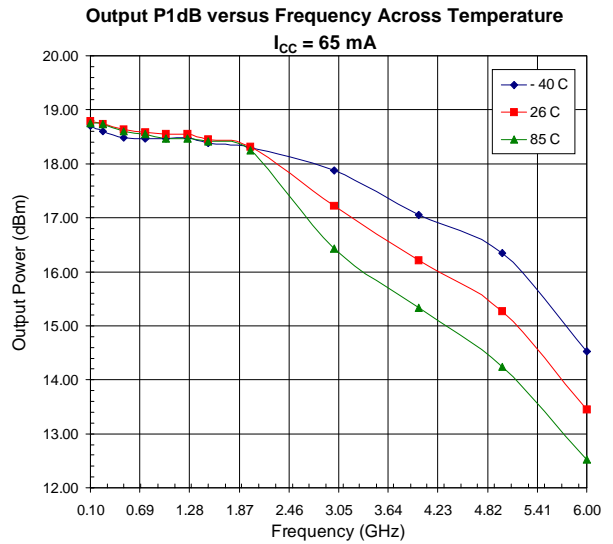
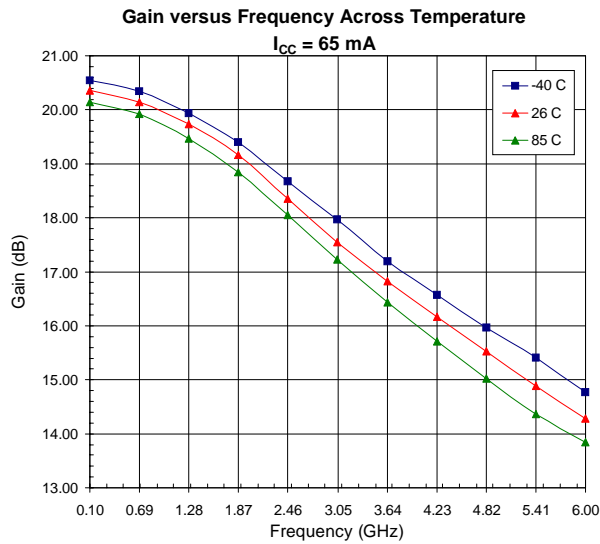

RF2044

Reverse Isolation versus Frequency Across Temperature

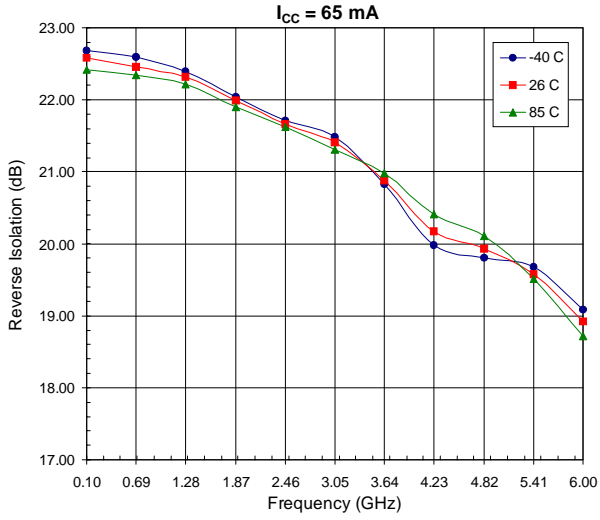

50 Ohm, 65 mA

