

# SPECIFICATION

<b>ITEM</b>	<b>CHIP LED DEVICE</b>
<b>MODEL</b>	<b>SSC-SWTS905</b>
<b>PART NO.</b>	<b>Rev1.00(060321)</b>

[Contents]

1. Features
2. Absolute maximum ratings
3. Electro-optical characteristics
4. Lot Number
5. Plating material
6. CIE Chromaticity Diagram
7. Soldering profile
8. Outline dimension
9. Packing
10. Reel packing structure
11. Precaution for use
12. Characteristic Diagram
13. Reliability

## 1. Features

- Package : 2.8 × 1.2 × 0.8 mm
- Tape and reel packing

## 2. Absolute Maximum Ratings

(Ta=25 °C)

Parameter	Symbol	Value	Unit
Power Dissipation	$P_d$	120	mW
Forward Current	$I_F$	30	mA
Peak Forward Current	$I_{FM}^{*1}$	100	mA
Reverse Voltage	$V_R$	5	V
Operating Temperature	$T_{opr}$	- 30 ~ +85	°C
Storage Temperature	$T_{stg}$	- 40 ~ +100	°C

\*1  $I_{FM}$  conditions: Pulse width  $T_w \leq 0.1$ ms, Duty ratio  $\leq 1/10$

Care is to be taken that Power Dissipation does not exceed the Absolute Maximum Rating of the product.

## 3. Electro-Optical Characteristics

(Ta=25 °C)

Item	Symbol	Condition	Min	Typ	Max	Unit	
Forward Voltage	Rank Y	$V_F$	$I_F=20$ mA	2.7	-	3.0	V
	Rank Z			3.0	-	3.3	
	Rank A			3.3	-	3.7	
	Rank B			3.7	-	3.9	
Reverse Current	$I_R$	$V_R=5$ V	-	-	50	$\mu$ A	
Luminous Intensity <sup>*1</sup>	Rank I5	$I_V$	$I_F=20$ mA	500	-	600	mcd
	Rank I6			600	-	700	
	Rank I7			700	-	800	
	Rank I8			800	-	900	
	Rank I9			900	-	1000	
	Rank J0			1000	-	1100	
	Rank J1			1100	-	1200	
	Rank J2			1200	-	1300	
Viewing Angle <sup>*2</sup>	$2\theta_{1/2}$	$I_F=20$ mA	120			°	

\*1 : The luminous intensity  $I_V$  is measured at the peak of the spatial pattern which may not be aligned with the mechanical axis of the LED package.  
Luminous Intensity Measurement allowance is  $\pm 10\%$ .

\*2 :  $\theta_{1/2}$  is the off-axis where the luminous intensity is 1/2 the peak intensity.

**\* Luminous Intensity**

Ranking by Luminous Intensity		Ranking by Color Coordinates							
		a	b	c	d	e	f	g	h
RANK	SSC PART NUMBER								
I5	A								
I6	B								
I7	C								
I8	D								
I9	E								
J0	F								
J1	G								
J2	H								

\* Shaded ranks are available

Note : All products confirm to the listed minimum and maximum specifications for electric and optical characteristics, when operated at 20mA within the maximum ratings shown above. All measurements were made under the standardized environment of SSC.

**4. Lot Number**

The lot number is composed of the following characters;

SWTS○□□◎◎ ◇◇◇

○ – Year (6 for 2006, 7 for 2007, 8 for 2008 )

□□ – Month ( 01 for Jan., 02 for Feb., .....11 for Nov., 12 for Dec.)

◎◎ – Day ( 01, 02, 03, 04, .....28, 29, 30, 31.)

◇◇◇ – Number of Tray ( 001, 002, 003, 004, 005, 006, .....)

**5. Plating material**

	Material
Base	Cu Alloy
Plating	Ag

## 6. CIE Chromaticity Diagram

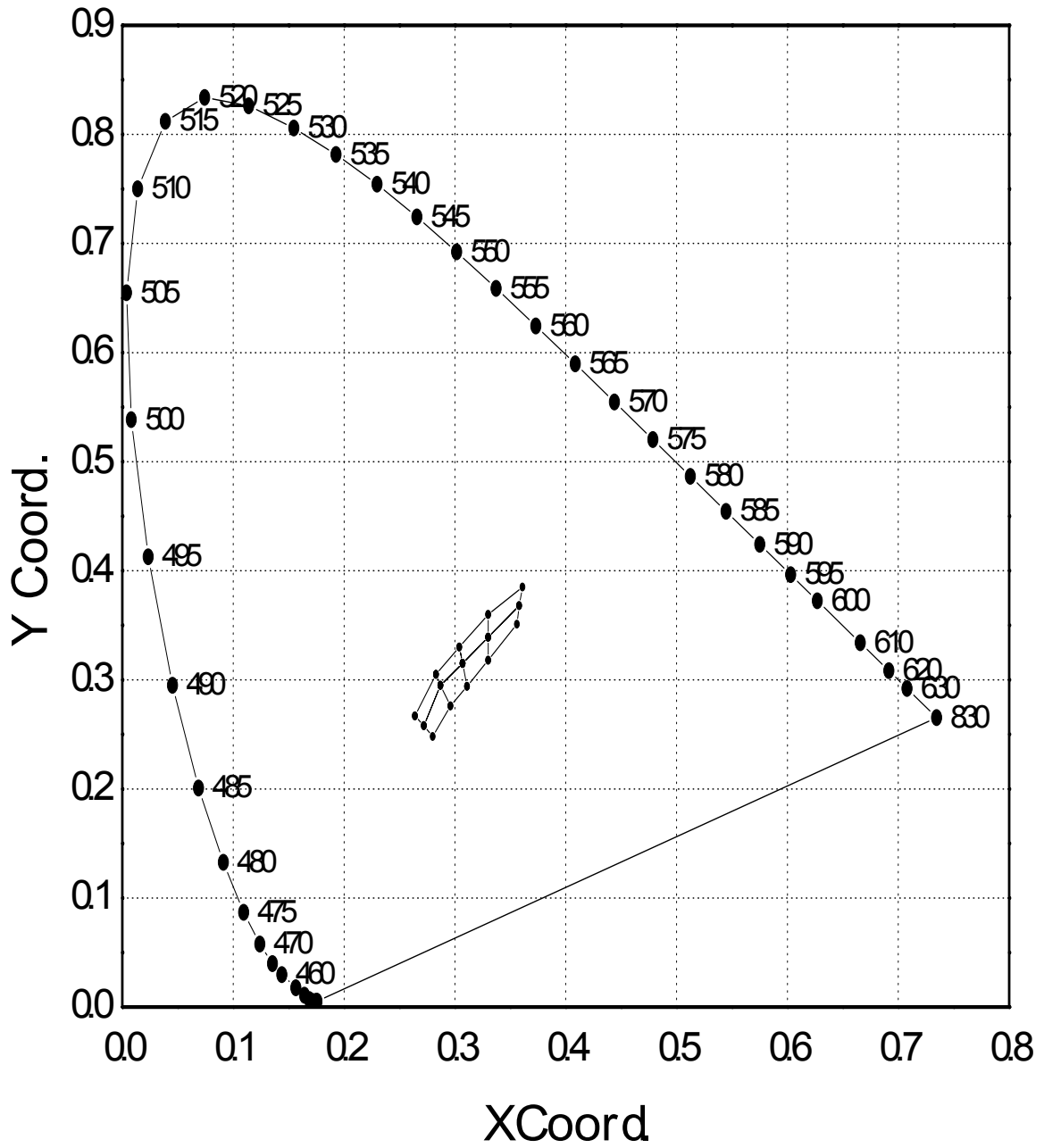

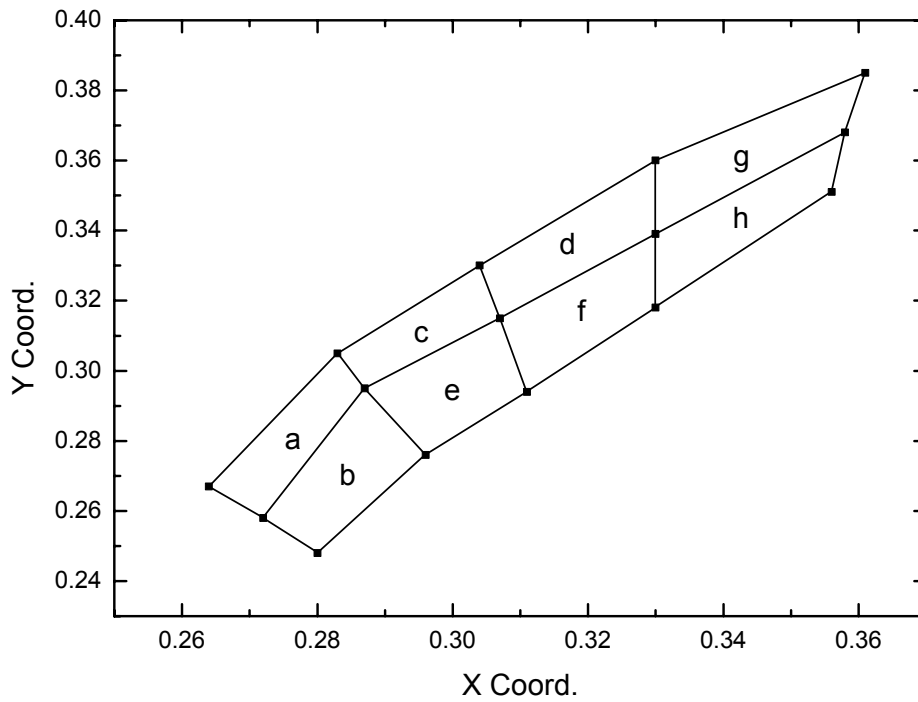

● **Color Rank**

( $I_F=20\text{mA}$ ,  $T_a=25^\circ\text{C}$ )

a		b		c		d	
x	y	x	y	x	y	x	y
0.264	0.267	0.272	0.258	0.283	0.305	0.307	0.315
0.272	0.258	0.280	0.248	0.287	0.295	0.330	0.339
0.287	0.296	0.296	0.276	0.307	0.315	0.330	0.360
0.283	0.305	0.287	0.295	0.304	0.330	0.304	0.330
e		f		g		h	
x	y	x	y	x	y	x	y
0.296	0.276	0.311	0.294	0.330	0.360	0.330	0.318
0.311	0.294	0.330	0.318	0.330	0.339	0.330	0.339
0.307	0.315	0.330	0.339	0.358	0.368	0.358	0.368
0.287	0.295	0.307	0.315	0.361	0.385	0.356	0.351

\* Measurement Uncertainty of the Color Coordinates :  $\pm 0.01$

## 7. Soldering Profile

The LED can be soldered in place using the reflow soldering method.

### (1) Lead solder

Preliminary heating to be at maximum 210°C for maximum 2 minutes.

Soldering heat to be at maximum 240°C for maximum 10 seconds.

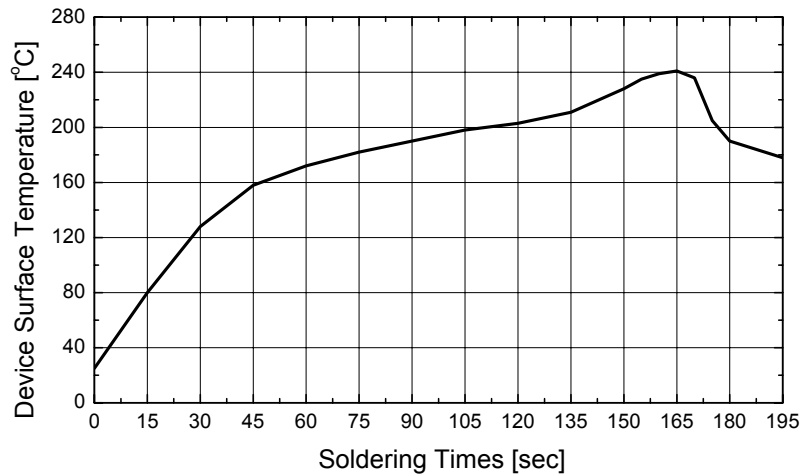

### (2) Lead-free solder

Preliminary heating to be at maximum 220°C for maximum 2 minutes.

Soldering heat to be at maximum 260°C for maximum 10 seconds.

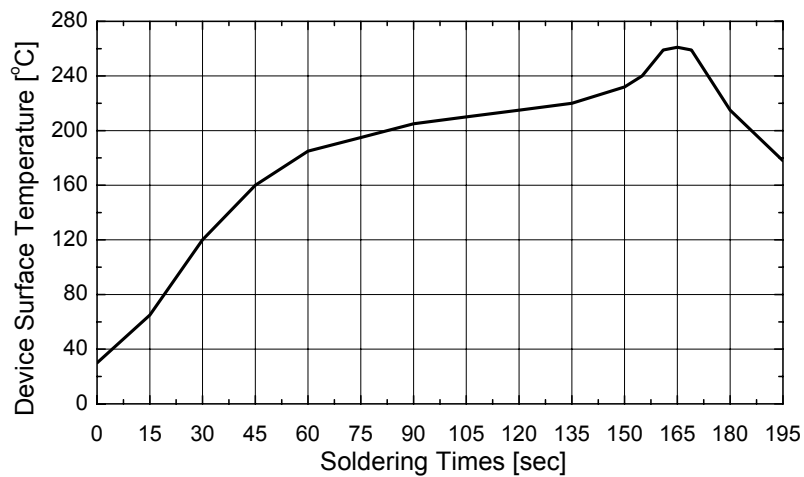

### (3) Hand Soldering conditions

Not more than 5 seconds @MAX300°C, under Soldering iron.

In case the soldered products are reused in soldering process, we don't guarantee the products.

## 8. Outline Dimension

(Tolerance:  $\pm 0.2$ , Unit: mm)

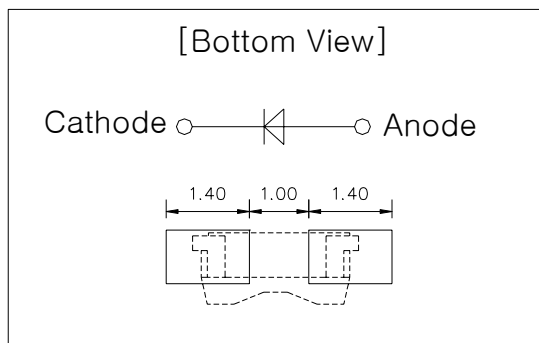
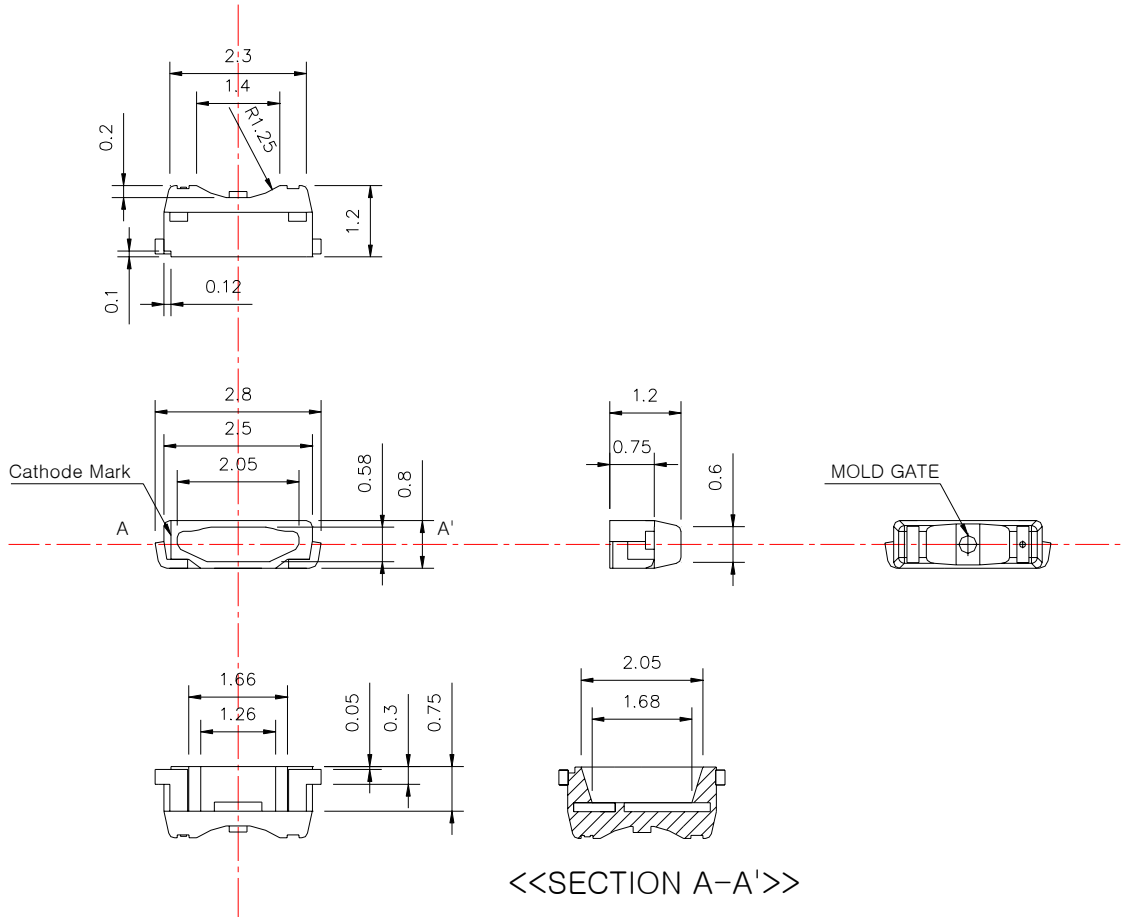

<Recommended solder Pattern>

## 9. Packing

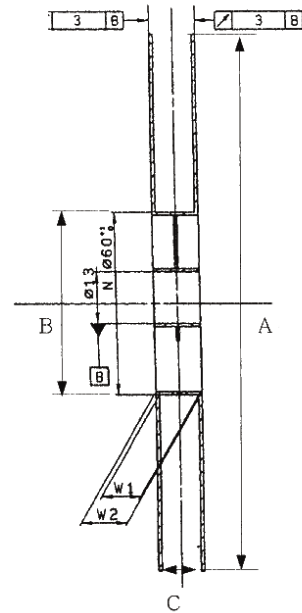
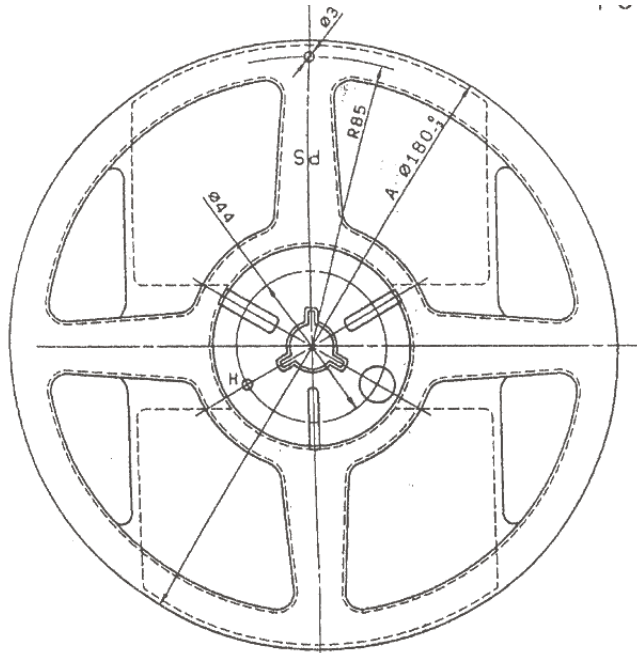
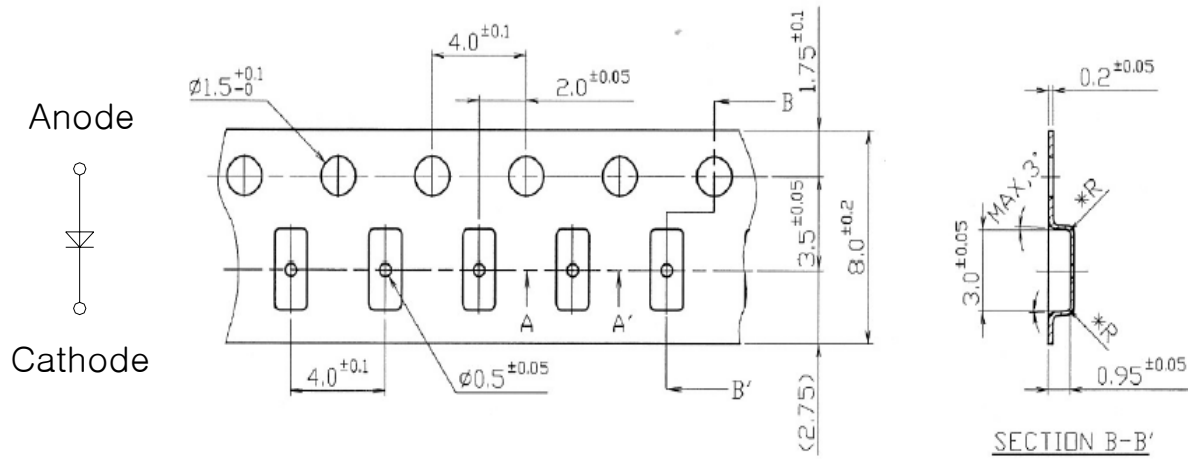

(Tolerance:  $\pm 0.2$ , Unit: mm)

- (1) Quantity : 3500pcs/Reel
- (2) Cumulative Tolerance : Cumulative Tolerance/10 pitches to be  $\pm 0.2$ mm
- (3) Adhesion Strength of Cover Tape : Adhesion strength to be 0.1-0.7N when the cover tape is turned off from the carrier tape at  $10^\circ$  angle to be the carrier tape
- (4) Package : P/N, Manufacturing data Code No. and quantity to be indicated on a damp proof Package



## 10. Reel Packing Structure

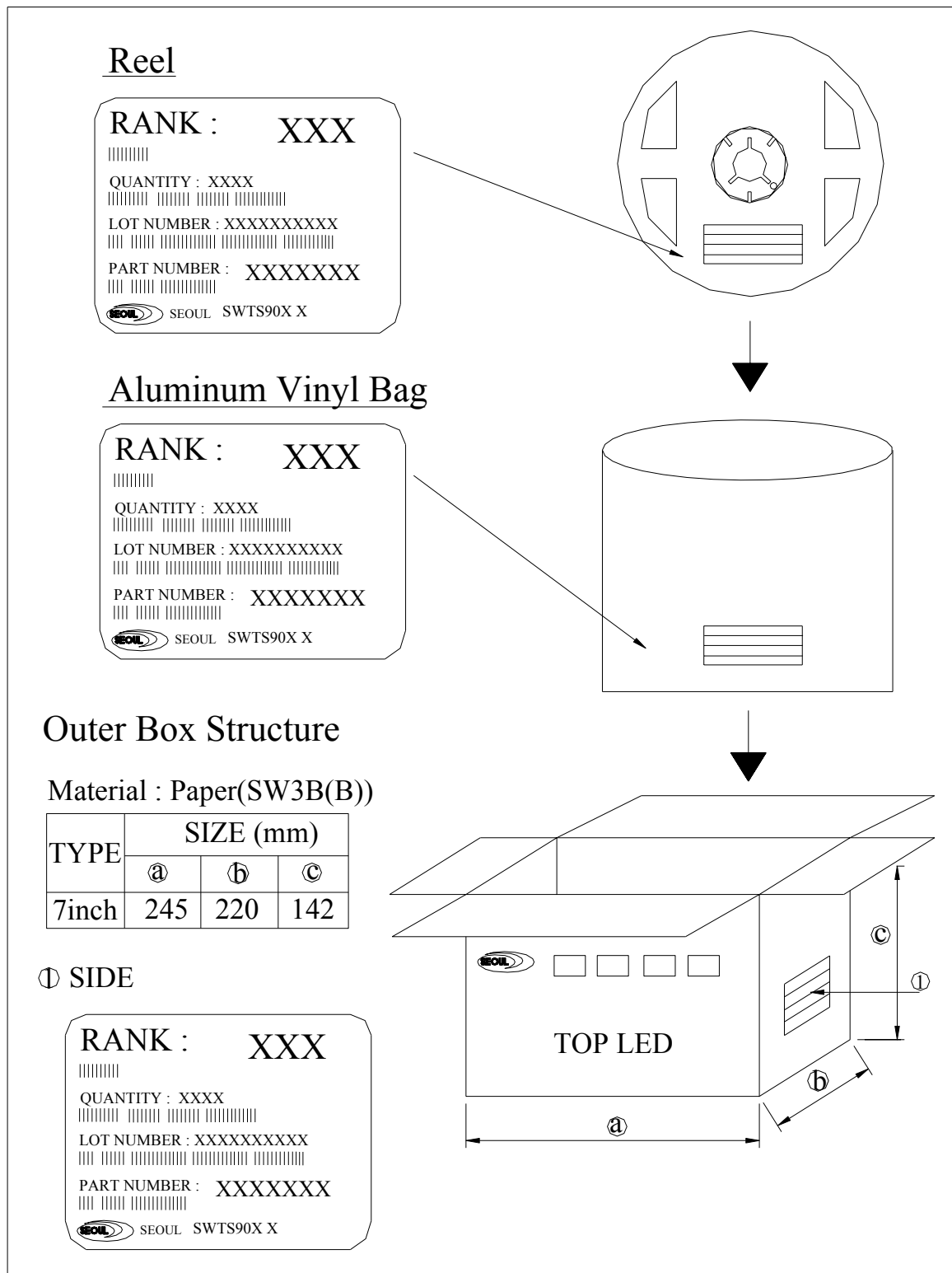

## 11. Precaution for use

### (1) Storage

In order to avoid the absorption of moisture, it is recommended to store in the dry box (or desiccator) with a desiccant . Otherwise, to store them in the following environment is recommended.

Temperature : 5°C~30°C, Humidity : 60%RH max.

### (2) Attention after opened

However LED is correspond SMD, when LED be soldered dip, interfacial separation may affect the light transmission efficiency, causing the light intensity to drop. Attention in followed.

a. After opened and mounted, the soldering shall be quickly.

b. Keeping of a fraction

Temperature : 5 ~ 40°C Humidity : less than 30%

(3) In case of more than 1 week passed after opening or change color of indicator on desiccant components shall be dried 10-12hr. at 60±5°C.

(4) In case of supposed the components is humid, shall be dried dip-solder just before.

100Hr at 80±5°C or 12Hr at 100±5°C.

(5) Any mechanical force or any excess vibration shall not be accepted to apply during cooling process to normal temp. after soldering.

(6) Quick cooling shall avoid.

(7) Components shall not be mounted on warped direction of PCB.

(8) Anti radioactive ray design is not considered for the products listed here in.

(9) This device should not be used in any type of fluid such as water, oil, organic solvent and etc. When washing is required, IPA should be used.

(10) When the LEDs are illuminating, operating current should be decided after considering the ambient maximum temperature.

(11) LEDs must be stored to maintain a clean atmosphere. If the LEDs are stored for 3 months or more after being shipped from SSC, a sealed container with a nitrogen atmosphere should be used for storage.

(12) The LEDs must be soldered within seven days after opening the moisture-proof packing.

(13) Repack unused products with anti-moisture packing, fold to close any opening and then store in a dry place.

(14) The appearance and specifications of the product may be modified for improvement without notice.

## 12. Characteristic Diagram

Forward Current vs Forward Voltage

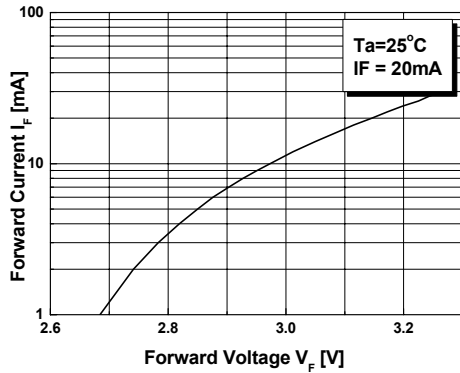

Intensity vs Forward Current

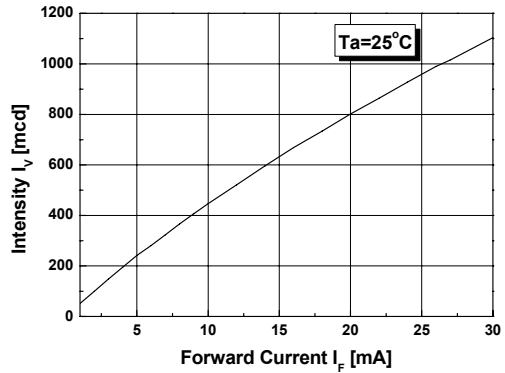

Forward Current Derating Curve

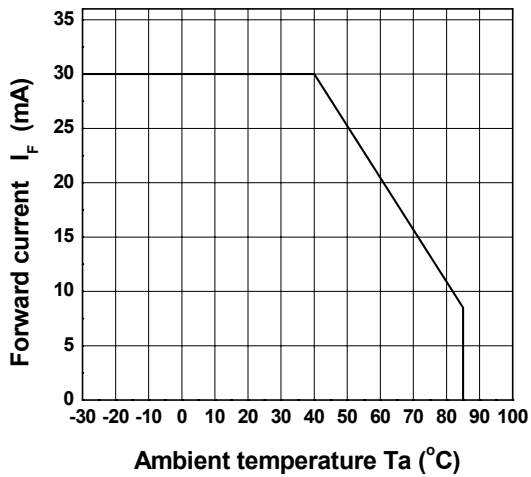

Radiation Diagram

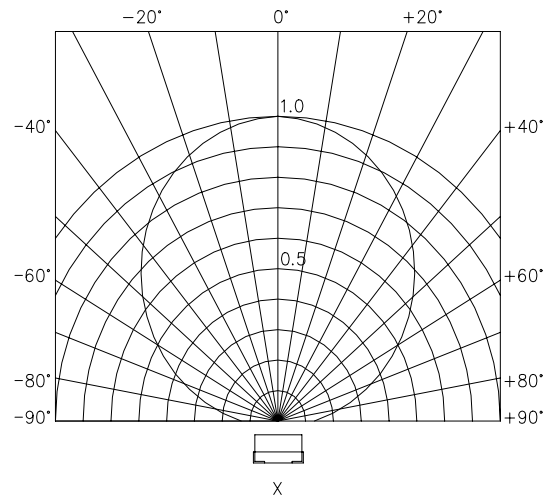

CIE Diagram vs Forward Current

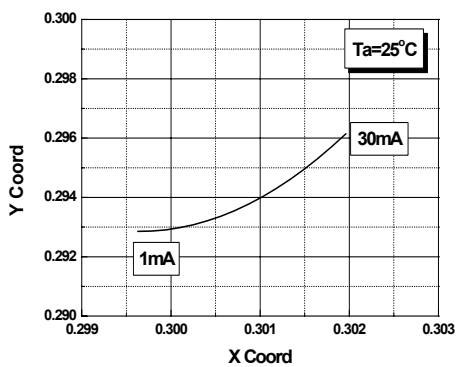

Spectrum

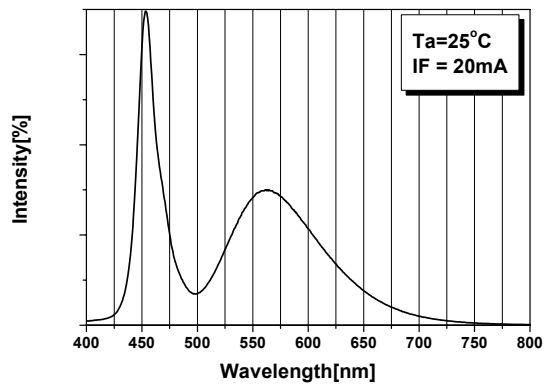

Ambient Temperature vs. Relative Luminosity.

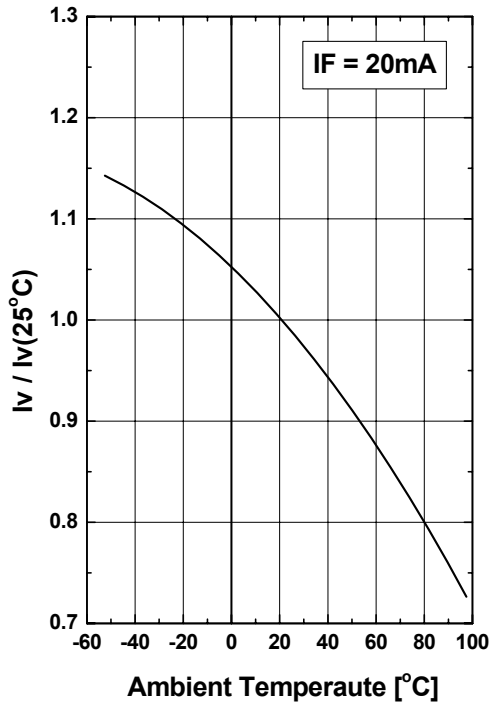

Duty Ratio vs. Allowable Forward Current.

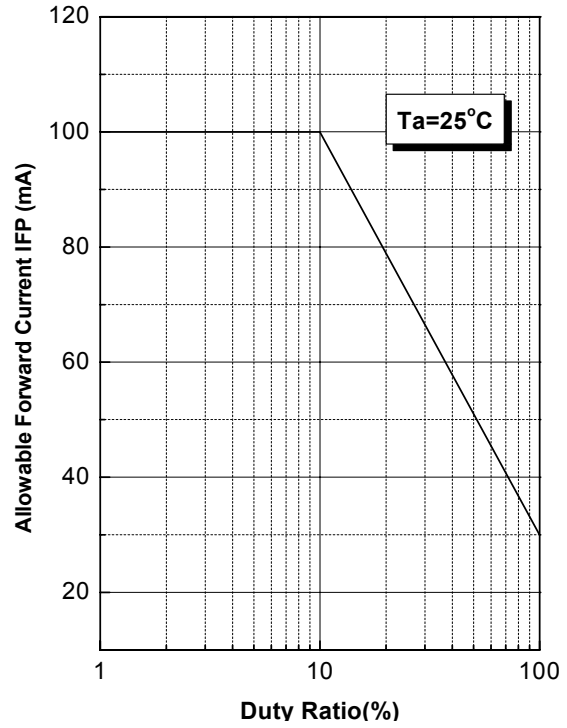

Ambient Temperature vs. Forward Voltage .

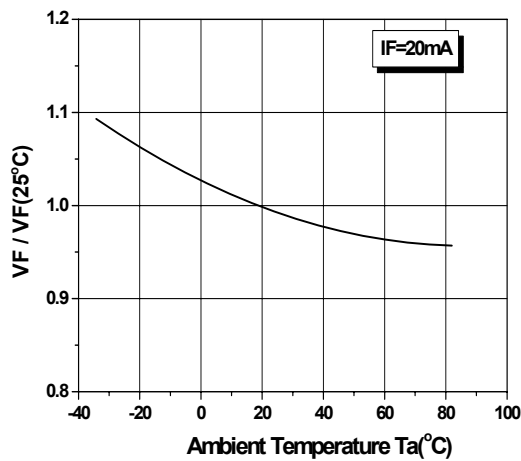

Ambient Temperature vs. Chromaticity Coordinate.

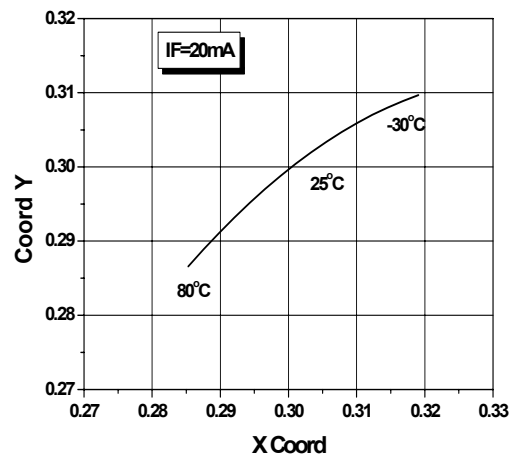

### 13. Reliability

#### (1) TEST ITEMS AND RESULTS

TEST ITEM	Test conditions	Note	Number of Damaged
Resistance to Soldering Heat	$T_{sld}=260^{\circ}\text{C}$ , 10sec. Pre treatment $30^{\circ}\text{C}$ , 70%, 168hrs	2 Times	0/50
Thermal Shock	$-30^{\circ}\text{C} \sim 85^{\circ}\text{C}$ 30min. 30min.	20 cycles	0/50
High Temperature Life Test	$T_a=85^{\circ}\text{C}$ ; $I_f=5\text{mA}$	1000 hrs.	0/20
Humidity Heat Load	$T_a=85^{\circ}\text{C}$ ; $RH=85\%$	1000 hrs.	0/50
Low Temperature Storage	$T_a=-40^{\circ}\text{C}$	1000 hrs.	0/50
Life Test	$T_a=25^{\circ}\text{C}$ ; $I_f=20\text{mA}$	1000 hrs.	0/20
High Temperature Storage	$T_a=100^{\circ}\text{C}$	1000 hrs.	0/50
High Humidity Heat Life Test	$T_a=85^{\circ}\text{C}$ ; $RH=85\%$ , $I_f=15\text{mA}$	500 hrs.	0/20
Low Temperature Life Test	$T_a=-30^{\circ}\text{C}$ ; $I_f=20\text{mA}$	1000 hrs.	0/20
Solderability (Reflow Soldering)	$T_{sld}=215 \pm 5^{\circ}\text{C}$ , 3sec. (Lead Solder)	1 Time over 95%	0/50
Temperature Cycle	$-40^{\circ}\text{C} \sim 25^{\circ}\text{C} \sim 100^{\circ}\text{C} \sim 25^{\circ}\text{C}$ 30min. 5min. 30min. 5min.	100 cycles	0/50
Moisture Resistance Cycle	$25^{\circ}\text{C} \sim 65^{\circ}\text{C} \sim -10^{\circ}\text{C}$ $RH=90\%$ , 24hrs./1cycle	10 cycles	0/50

#### (2) CRITERIA FOR JUDGING THE DAMAGE

Item	Symbol	Test Condition	Criteria for Judgment	
			Min.	Max.
Forward Voltage	$V_F$	$I_f=20\text{mA}$	-	U.S.L $\times$ 1.2
Reverse Current	$I_R$	$V_R=5\text{V}$	-	U.S.L $\times$ 2.0
Luminous Intensity	$I_V$	$I_f=20\text{mA}$	L.S.L $\times$ 0.5	-

U.S.L. : Upper Standard Level

L.S.L. : Lower Standard Level