



# A23L1616/A23L16161/A23L16162 Series

**Preliminary**

**2M X 16 / 4M X 8 BIT CMOS MASK ROM**

---

## Document Title

**2M X 16 / 4M X 8 BIT CMOS MASK ROM**

## Revision History

<u>Rev. No.</u>	<u>History</u>	<u>Issue Date</u>	<u>Remark</u>
0.0	Initial issue	June 26, 2001	Preliminary
0.1	Change Access Time: From 100ns(max.)/3.0V~3.6V to 70ns(max.)/3.0V~3.6V & From 120ns(max.)/2.7V~3.6V to 100ns(max.)/2.7V~3.6V Change Operating Current: From 40mA(max.)/3.6V to 40mA(typ.)/3.3V Change Standby Current: From 30 $\mu$ A(max.)/3.6V to 10 $\mu$ A(typ.)/3.3V	September 13, 2002	



# A23L1616/A23L16161/A23L16162 Series

**Preliminary**

**2M X 16 / 4M X 8 BIT CMOS MASK ROM**

## Features

- 2M x 16 bit or 4M x 8 bit organization
- Supply voltage range: 2.7V~3.6V
- Access time: 70ns (max.)/3.0V~3.6V  
100ns (max.)/2.7V~3.6V
- Current: Operating: 40mA (typ.)/3.3V  
Standby: 10µA (typ.)/3.3V
- Three-state outputs for wired-OR expansion
- Full static operation
- All inputs and outputs are directly TTL-compatible
- Flash memory pinout compatible with AMD (A23L16161) and Intel (A23L16162)
- Available in 44-pin SOP, 48-pin TSOP (forward, reverse type and flash memory's pinouts compatible) packages

## Pin Configurations

### ■ SOP

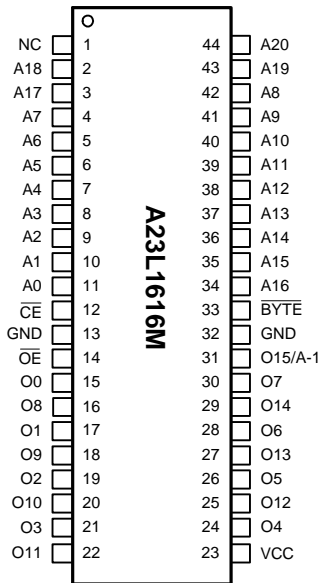

### ■ TSOP (forward type)



### ■ TSOP (reverse type)

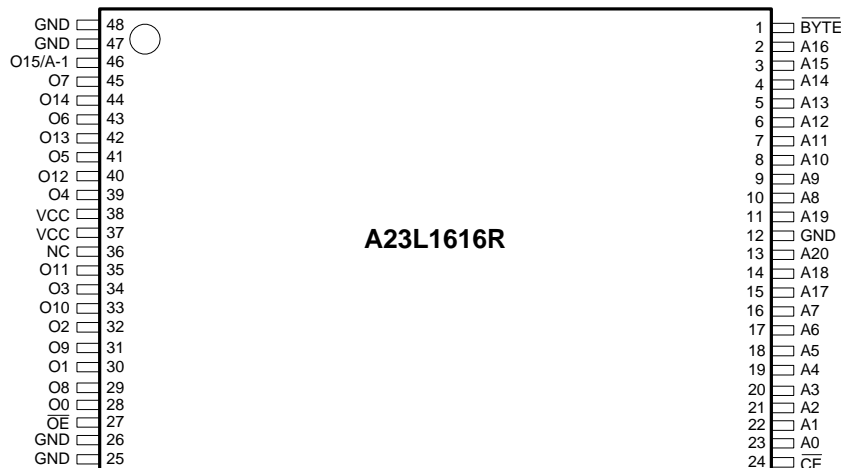

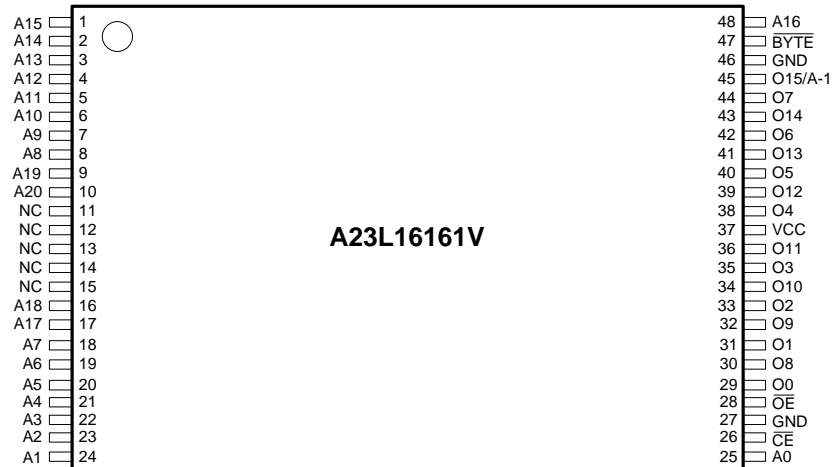
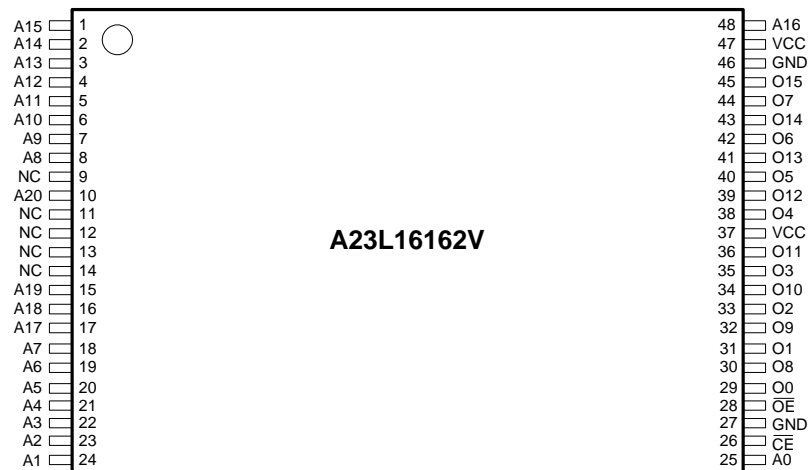
**Pin Configurations (continued)**
**■ TSOP (forward type)**

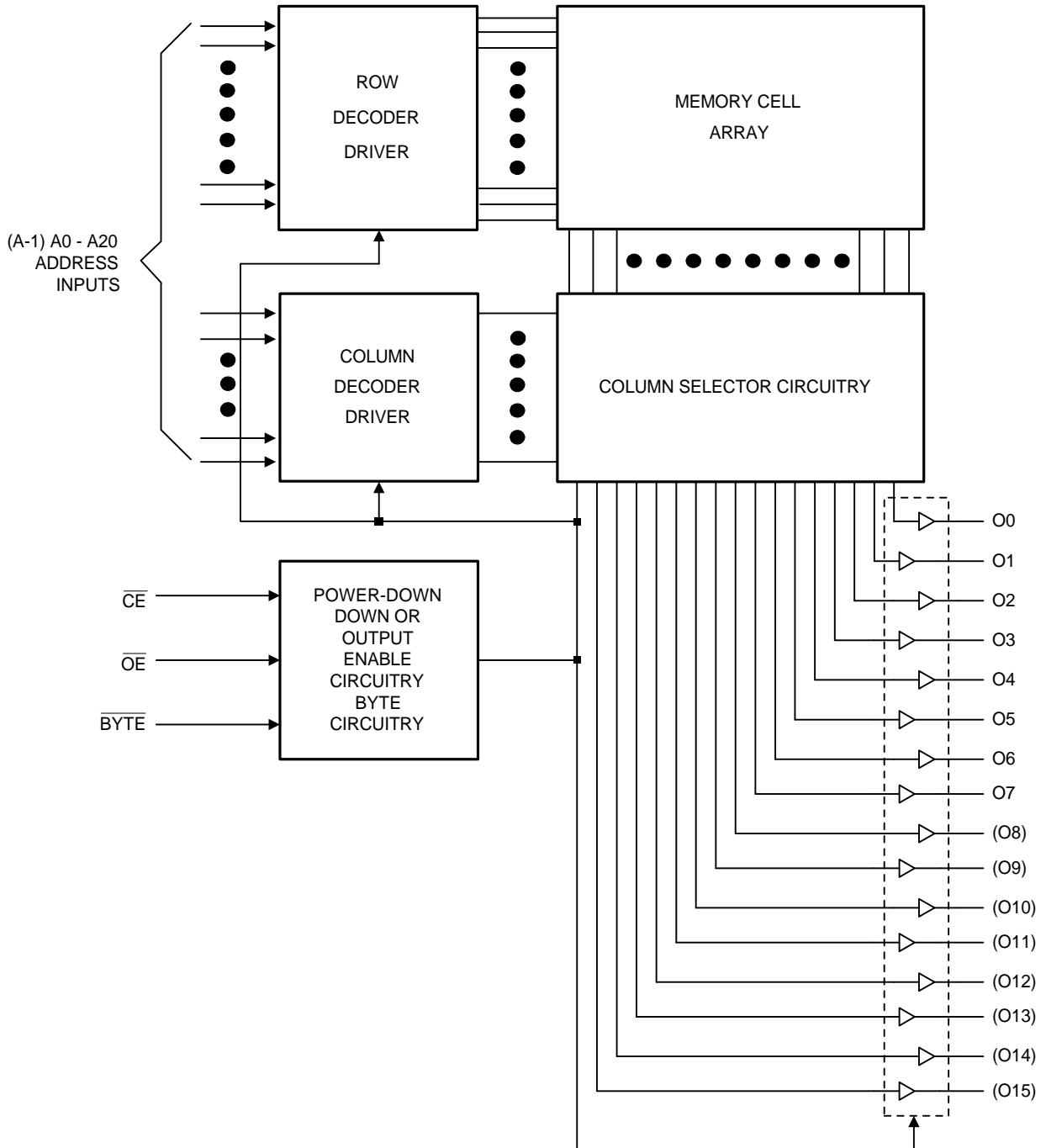
**■ TSOP (forward type)**

**Block Diagram**



**Pin Descriptions**

Pin No.				Symbol	Description
44L SOP (A23L1616)	48L TSOP (A23L1616)	48L TSOP (A23L16161)	48L TSOP (A23L16162)		
2-11, 34-44	2-11, 13-23	1-10, 16-25, 48	1-8, 10 15-25, 48	A0-A20	Address Inputs
15-22, 24-30	28-35, 39-45	29-36, 38-44	29-36, 38-44	O0-O14	Data Outputs
31	46	45	45	O15/A-1	Output 15(WORD mode) /LSB Address (BYTE mode)
12	24	26	26	$\overline{CE}$	Chip Enable Input
14	27	28	28	$\overline{OE}$	Output Enable Input
33	1	47	-	$\overline{BYTE}$	BYTE or WORD mode Selection
23	37-38	37	37, 47	VCC	Power Supply
13, 32	12, 25-26, 47-48	27, 46	27, 46	GND	Ground
1	36	11-15	9, 11-14	NC	No Connection

**Recommended DC Operating Conditions**

(T<sub>A</sub> = 0°C to + 70°C)

Symbol	Parameter	Min.	Max.	Unit
VCC	Supply Voltage	2.7	3.6	V
GND	Ground	0	0	V
V <sub>IH</sub>	Input High Voltage	2.2	VCC+0.3	V
V <sub>IL</sub>	Input Low Voltage	- 0.3	0.6	V



## A23L1616/A23L16161/A23L16162 Series

### Absolute Maximum Ratings\*

Ambient Operating Temperature . . . . . 0°C to + 70°C  
 Storage Temperature . . . . . -65°C to + 125°C  
 Output Voltage . . . . . -0.5V to VCC + 0.5V  
 Input Voltage . . . . . -0.5V to VCC + 0.5V

### \*Comments

Stresses above those listed under "Absolute Maximum Ratings" may cause permanent damage to this device. These are stress ratings only. Functional operation of this device at these or any other conditions above those indicated in the operational sections of this specification is not implied or intended. Exposure to the absolute maximum rating conditions for extended periods may affect device reliability.

### DC Electrical Characteristics (TA = 0°C to + 70°C, VCC = 3.0V~3.6V, GND = 0V)

Symbol	Parameter	Min.	Max.	Unit	Conditions	Note
V <sub>OH</sub>	Output High Voltage	2.4		V	I <sub>OH</sub> = -0.4mA (3V)	
V <sub>OL</sub>	Output Low Voltage		0.4	V	I <sub>OL</sub> = 1.6mA (3V)	
V <sub>IH</sub>	Input High Voltage	2.2	VCC + 0.3	V		
V <sub>IL</sub>	Input Low Voltage	-0.3	0.6	V		
I <sub>LI</sub>	Input Leakage Current		+10	μA	VCC = max. V <sub>IN</sub> = VCC to GND	
I <sub>LO</sub>	Output Leakage Current		+10	μA	VCC = max. V <sub>OUT</sub> = VCC to GND	1
I <sub>CC</sub>	Operating Supply Current		60	mA	t <sub>cy</sub> = min.	2
I <sub>SB</sub>	Standby Supply Current (TTL)		1.5	mA	$\overline{CE} = V_{IH}$	
I <sub>SB1</sub>	Standby Supply Current (CMOS)		30	μA	$\overline{CE} = VCC - 0.2V$	



**Capacitance**

Symbol	Parameter	Min.	Max.	Unit	Test Conditions	Note
C <sub>i</sub>	Input Capacitance		10	pF	T <sub>A</sub> = 25°C f = 1.0MHz	3
C <sub>o</sub>	Output Capacitance		10	pF		

**AC Characteristics** (T<sub>A</sub> = 0°C to +70°C, VCC = 2.7V~3.6V for -12, VCC = 3.0V~3.6V for -10, GND = 0V)

Symbol	Parameter	A23L1616/A23L16161/A23L16162-70		A23L1616/A23L1616161/A23L16162-100		Unit	Note
		Min.	Max.	Min.	Max.		
t <sub>cy</sub>	Cycle Time	70		100		ns	
t <sub>AA</sub>	Address Access Time		70		100	ns	
t <sub>ACE</sub>	Chip Enable Access Time		70		100	ns	
t <sub>AOE</sub>	Output Enable Access Time		35		50	ns	
t <sub>OH</sub>	Output Hold after Address Change	10		10		ns	
t <sub>LZ</sub>	Output Low Z Delay	10		10		ns	4, 6
t <sub>HZ</sub>	Output High Z Delay*		20		20	ns	5, 6

\* t<sub>HZ</sub> is specified from either  $\overline{OE}$  or  $\overline{CE}$  going disabled, whichever occurs first.

Notes:

1.  $\overline{OE} / \overline{CE} = V_{IH}$  (Output is unloaded)
2.  $V_{IN} = V_{IH}/V_{IL}$ ,  $\overline{OE} / \overline{CE} = V_{IL}$  (Output is unloaded)
3. This parameter is periodically sampled and is not 100% tested. All pins, except pins under test, are tied to AC ground.
4. Output LOW impedance delay (t<sub>LZ</sub>) is measured from  $\overline{CE}$  or  $\overline{OE}$  going active.
5. Output HIGH impedance delay (t<sub>HZ</sub>) is measured from  $\overline{CE}$  or  $\overline{OE}$  going inactive.
6. This parameter is sampled and not 100% tested.

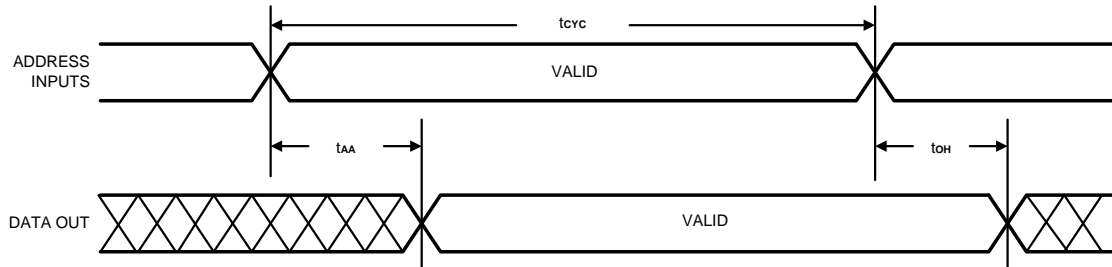
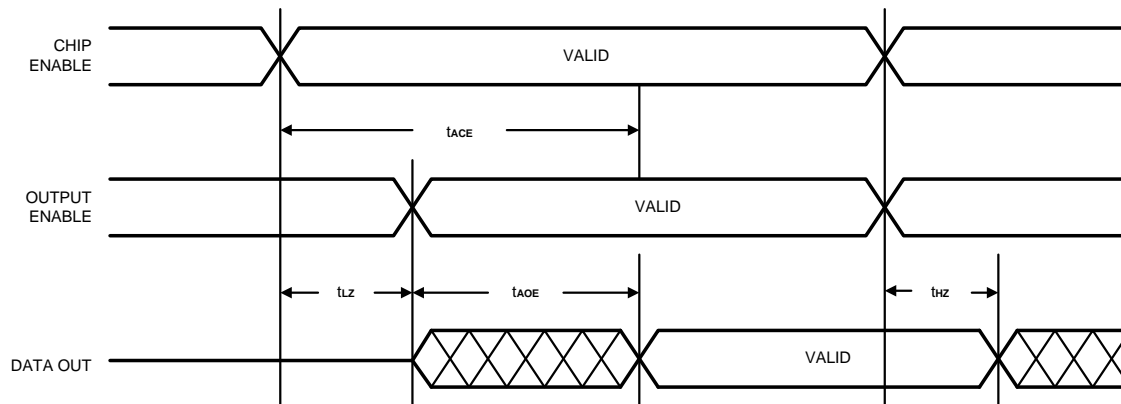
**Timing Waveforms**
**Propagation Delay from Address ( $\overline{CE}$  = Active,  $\overline{OE}$  = Active)**

**Propagation Delay from Chip Enable or Output Enable (Address Valid)**

**AC Test Conditions**

Part No.	A23L1616/A23L16161/A23L16162-70	A23L1616/A23L16161/A23L16162-100
Applied Voltage	3.0V~3.6V	2.7V~3.6V
Input Pulse Levels	0.4V to 2.4V	0.4V to 2.4V
Input Rise and Fall Time	10 ns	10 ns
Timing Measurement Reference Level	$V_{IN} = 1.4V, V_{OUT} = 1.4V$	$V_{IN} = 1.4V, V_{OUT} = 1.4V$
Output Load	1 TTL gate and $C_L = 100pF$	1 TTL gate and $C_L = 100pF$





## A23L1616/A23L16161/A23L16162 Series

### Function Table

$\overline{\text{CE}}$	$\overline{\text{OE/NC}}$	$\overline{\text{BYTE}}$	O15/A-1	O0 - O7	O8 - O15	Mode
L	L	H	Data Pin O15	Data Out	Data out	Word
L	L	L	LSB Address A-1	Data Out	Hi - Z	Byte
H	X	X	X	Hi - Z	Hi - Z	Power-down
L	H	X	X	Hi - Z	Hi - Z	Output Disable

### Ordering Information

Part No.	Access Time (ns)	Package
A23L1616M-70	70	44L SOP
A23L1616M-100	100	44L SOP
A23L1616V-70	70	48L TSOP (Forward)
A23L1616V-100	100	48L TSOP (Forward)
A23L1616R-70	70	48L TSOP (Reverse)
A23L1616R-100	100	48L TSOP (Reverse)
A23L16161V-70	70	48L TSOP AMD (Flash Compatible)
A23L16161V-100	100	48L TSOP AMD (Flash Compatible)
A23L16162V-70	70	48L TSOP Intel (Flash Compatible)
A23L16162V-100	100	48L TSOP Intel (Flash Compatible)

**Package Information**
**SOP 44L Outline Dimensions**

unit: inches/mm

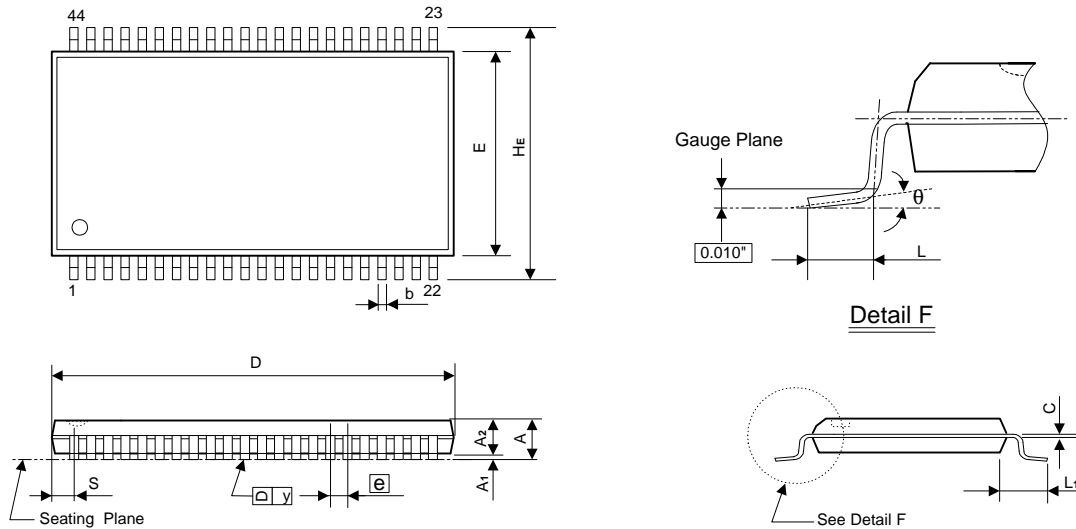

Symbol	Dimensions in inches			Dimensions in mm		
	Min	Nom	Max	Min	Nom	Max
A	-	-	0.118	-	-	3.00
A1	0.004	-	-	0.10	-	-
A2	0.103	0.106	0.109	2.62	2.69	2.77
b	0.013	0.016	0.020	0.33	0.40	0.50
C	0.007	0.008	0.010	0.18	0.20	0.25
D	-	1.122	1.130	-	28.50	28.70
E	0.490	0.496	0.500	12.45	12.60	12.70
e	-	0.050	-	-	1.27	-
HE	0.620	0.631	0.643	15.75	16.03	16.33
L	0.024	0.032	0.040	0.61	0.80	1.02
L1	-	0.0675	-	-	1.71	-
S	-	-	0.045	-	-	1.14
y	-	-	0.004	-	-	0.10
θ	0°	-	8°	0°	-	8°

**Notes:**

1. The maximum value of dimension D includes end flash.
2. Dimension E does not include resin fins.
3. Dimension S includes end flash.

**Package Information**
**TSOP 48L (Type I) Outline Dimensions**

unit: inches/mm

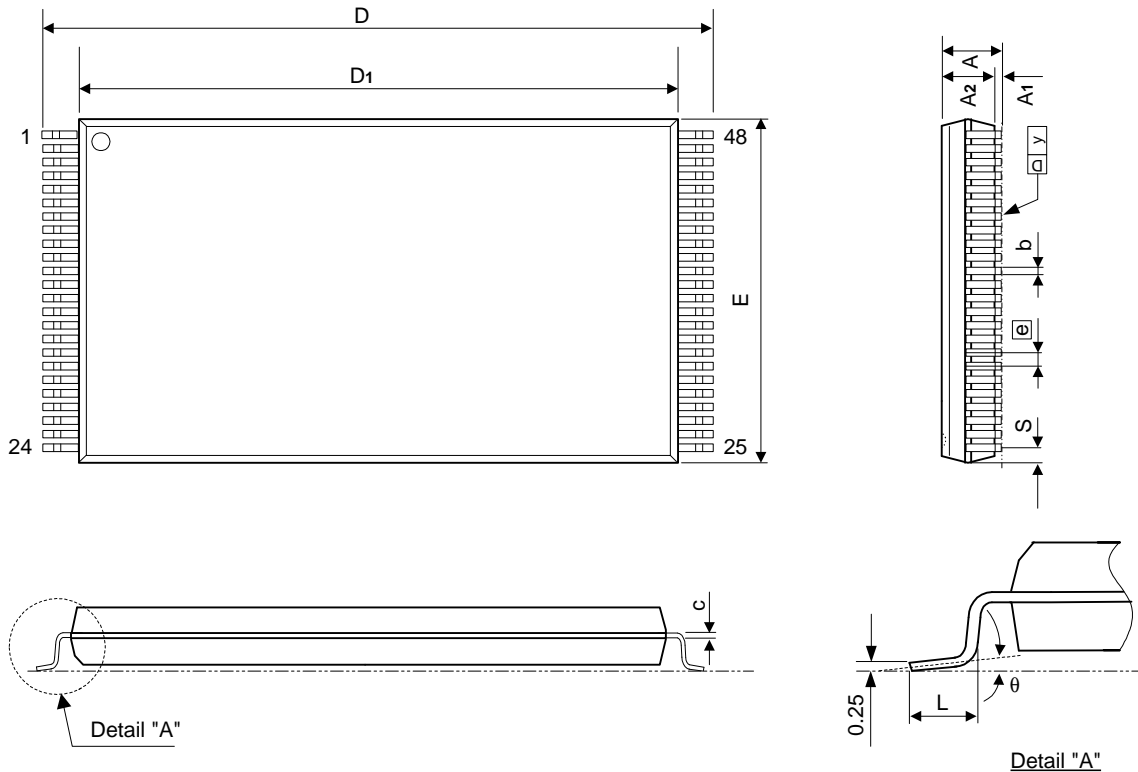

Symbol	Dimensions in inches			Dimensions in mm		
	Min	Nom	Max	Min	Nom	Max
A	-	-	0.047	-	-	1.20
A <sub>1</sub>	0.002	-	0.006	0.05	-	0.15
A <sub>2</sub>	0.037	0.039	0.042	0.94	1.00	1.06
b	0.007	0.009	0.011	0.18	0.22	0.27
c	0.004	-	0.008	0.12	-	0.20
D	0.779	0.787	0.795	19.80	20.00	20.20
D <sub>1</sub>	0.720	0.724	0.728	18.30	18.40	18.50
E	-	0.472	0.476	-	12.00	12.10
e	0.020 BASIC			0.50 BASIC		
L	0.016	0.020	0.024	0.40	0.50	0.60
S	0.011 Typ.			0.28 Typ.		
y	-	-	0.004	-	-	0.10
θ	0°	-	8°	0°	-	8°

**Notes:**

1. The maximum value of dimension D includes end flash.
2. Dimension E does not include resin fins.
3. Dimension S includes end flash.