

**SILICON DIAC  
BIDIRECTIONAL TRIGGER DIODE  
GLASS PASSIVATED PNPN DEVICE**

**CLLDB3**

**SOD - 80C  
Mini MELF (LL-34)**

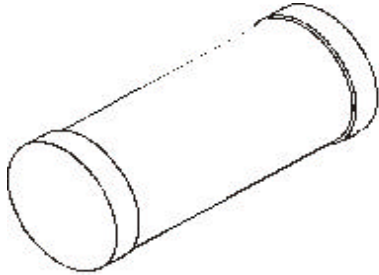

Functioning as a Trigger Diode with a Fixed Voltage Reference, CLLDB3 can be used in Conjunction with Triacs for Simplified Gate Control Circuits or as a Starting Element in Fluorescent Lamp Ballasts

**ABSOLUTE MAXIMUM RATINGS ( $T_a=25^\circ\text{C}$  unless specified otherwise))**

DESCRIPTION	SYMBOL	VALUE	UNIT
Power Dissipation on Printed Circuit (L=10mm) ( $T_a=50^\circ\text{C}$ )	$P_{\text{tot}}$	150	mW
Up to $T_a = 50^\circ\text{C}$ and Mounted on a Ceramic Substrate of 10mm x 10mm x 0.6mm	$P_{\text{tot}}$	120	mW
Repetitive Peak on-State Current ( $t_p=20\text{ms}$ , $f=100\text{Hz}$ )	$I_{\text{TRM}}$	2	A
Storage Temperature Range	$T_{\text{stg}}$	- 40 to +125	$^\circ\text{C}$
Junction Temperature Range	$T_j$	- 40 to +110	$^\circ\text{C}$
<b>THERMAL RESISTANCE</b>			
Junction to Ambient in free air	$R_{\text{th(j-a)}}$	400	$^\circ\text{C/W}$
Junction-Leads	$R_{\text{th(j-l)}}$	150	$^\circ\text{C/W}$

**ELECTRICAL CHARACTERISTICS ( $T_j=25^\circ\text{C}$  unless specified otherwise)**

DESCRIPTION	SYMBOL	TEST CONDITIONS	MIN	MAX	UNIT
* Breakover Voltage	$V_{\text{BO}}$	** C = 22nF see diagram 1	28	36	V
Breakover Voltage Symmetry	$[ +V_{\text{BO}} - -V_{\text{BO}} ]$	** C = 22nF see diagram 1		$\pm 3$	V
* Dynamic Breakover Voltage	$ \Delta V_{\pm} $	$\Delta I=[I_{\text{BO}} \text{ to } I_{\text{F}}=10\text{mA}]$ see diagram 1	5		V
* Output Voltage	$V_{\text{O}}$	see diagram 2	5		V
* Breakover Current	$I_{\text{BO}}$	** C = 22nF		50	$\mu\text{A}$
* Rise Time	$t_r$	see diagram 3	TYP 1.5		$\mu\text{s}$
* Leakage Current	$I_{\text{B}}$	$V_{\text{B}} = 0.5 V_{\text{BO}} \text{ max}$ see diagram 1		10	$\mu\text{A}$

\* Electrical characteristic applicable in both forward and reverse directions

\*\* Connected in parallel with the devices.

**CLLDB3**

**DIAGRAM 1** :Current-voltage characteristics

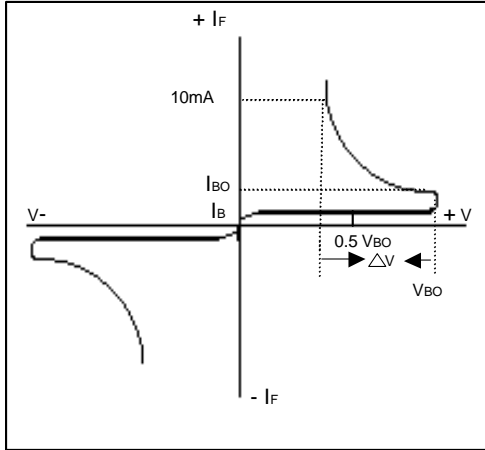

**DIAGRAM 2** :Test circuit for output voltage

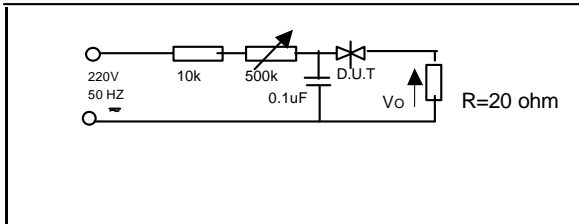

**DIAGRAM 3** : Test circuit see diagram 2.  
Adjust R for  $I_p=0.5A$

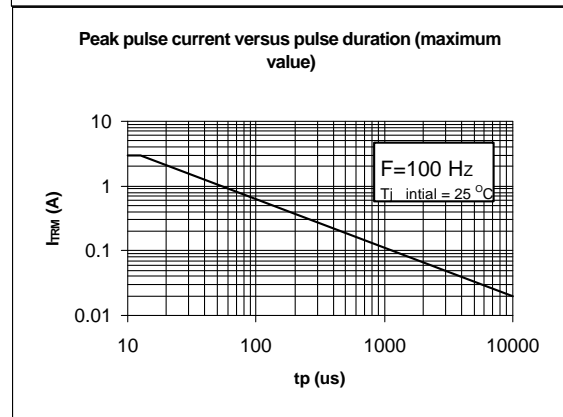
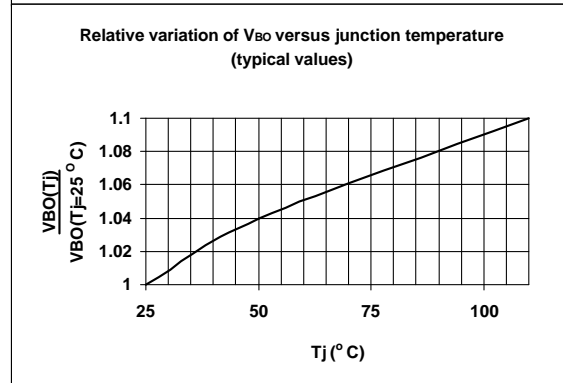
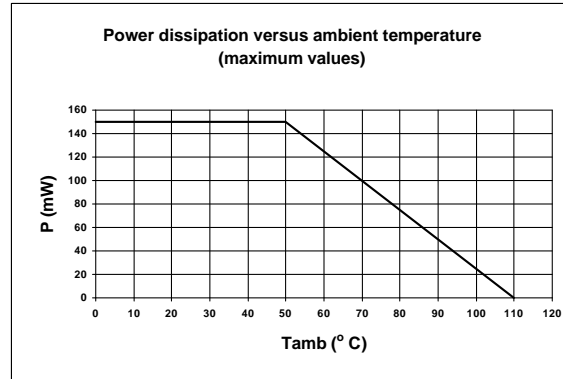
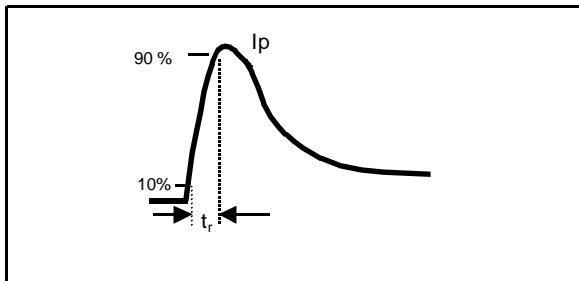

SOD 80C (LL-34) Mini MELF Hermetically Sealed Glass Package

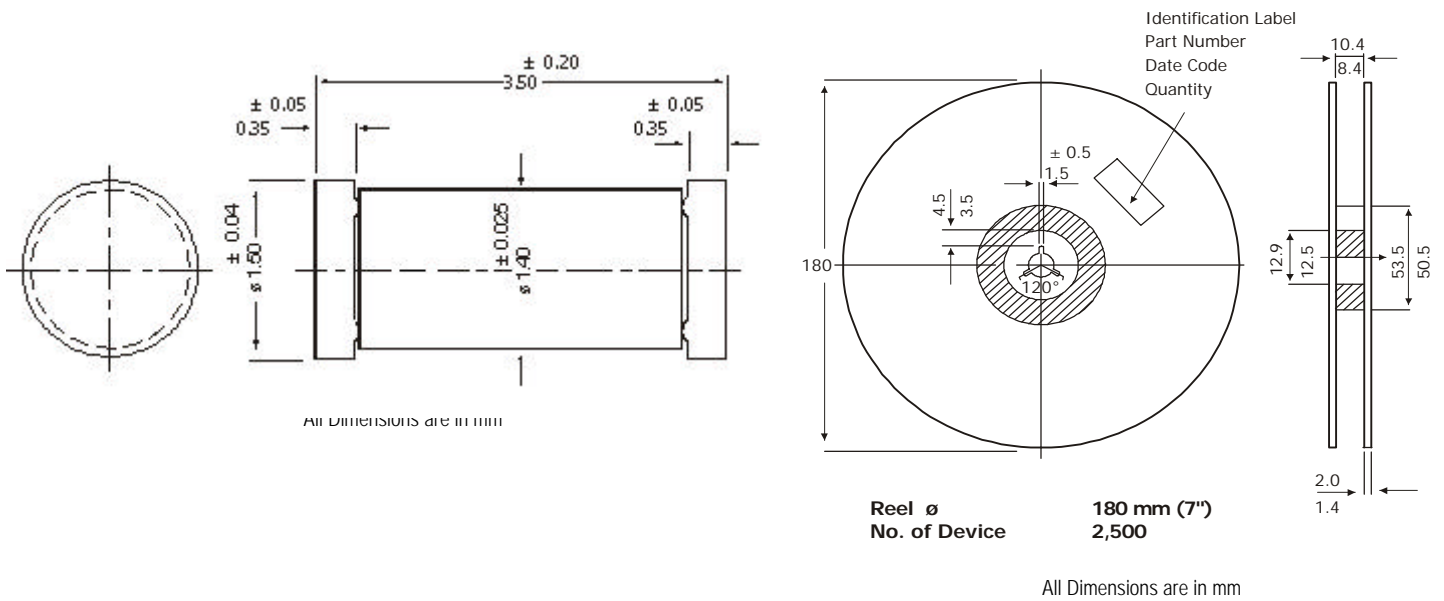

TAPE & REEL

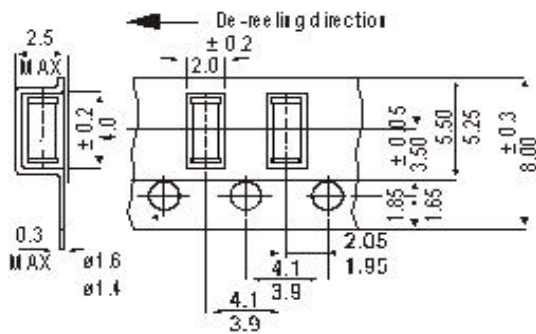

Notes:

1. Maximum of 0.5% of the total number of components per reel may be missing-exclusively at the beginning and at the end of the reel.
2. A maximum of three consecutive components may be missing, provided this gap is followed by six consecutive components.

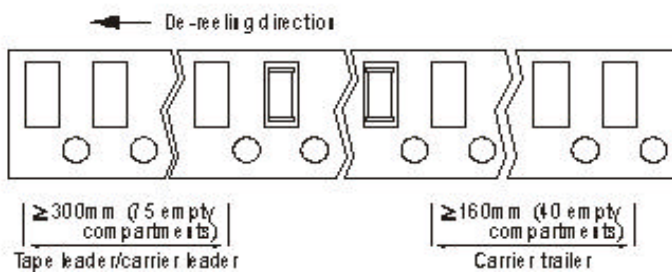

All Dimensions are in mm

Drawings are not to scale

Packing Detail

PACKAGE	STANDARD PACK		INNER CARTON BOX		OUTER CARTON BOX		
	Details	Net Weight/Qty	Size	Qty	Size	Qty	Gr Wt
SOD-80C T&R	2.5K/reel	225 gm/2.5K pcs	9" x 9" x 9"	40K	18" x 12" x 10" 19" x 19" x 20"	80K 320K	7.2 kgs 28.8 kgs

### **Disclaimer**

The product information and the selection guides facilitate selection of the CDIL's Discrete Semiconductor Device(s) best suited for application in your product(s) as per your requirement. It is recommended that you completely review our Data Sheet(s) so as to confirm that the Device(s) meet functionality parameters for your application. The information furnished in the Data Sheet and on the CDIL Web Site/CD are believed to be accurate and reliable. CDIL however, does not assume responsibility for inaccuracies or incomplete information. Furthermore, CDIL does not assume liability whatsoever, arising out of the application or use of any CDIL product; neither does it convey any license under its patent rights nor rights of others. These products are not designed for use in life saving/support appliances or systems. CDIL customers selling these products (either as individual Discrete Semiconductor Devices or incorporated in their end products), in any life saving/support appliances or systems or applications do so at their own risk and CDIL will not be responsible for any damages resulting from such sale(s).

CDIL strives for continuous improvement and reserves the right to change the specifications of its products without prior notice.



CDIL is a registered Trademark of  
Continental Device India Limited

C-120 Naraina Industrial Area, New Delhi 110 028, India.  
Telephone + 91-11-2579 6150, 5141 1112 Fax + 91-11-2579 5290, 5141 1119  
email@cdil.com www.cdilsemi.com