

## Product Description

Sirenza Microdevices' SGA-4163 is a high performance SiGe HBT MMIC Amplifier. A Darlington configuration featuring 1 micron emitters provides high  $F_T$  and excellent thermal performance. The heterojunction increases breakdown voltage and minimizes leakage current between junctions. Cancellation of emitter junction non-linearities results in higher suppression of intermodulation products. At 850 Mhz and 45mA, the SGA-4163 typically provides +29.7 dBm output IP3, 10.5 dB of gain, and +13 dBm of 1dB compressed power using a single positive voltage supply. Only 2 DC-blocking capacitors, a bias resistor and an optional RF choke are required for operation.

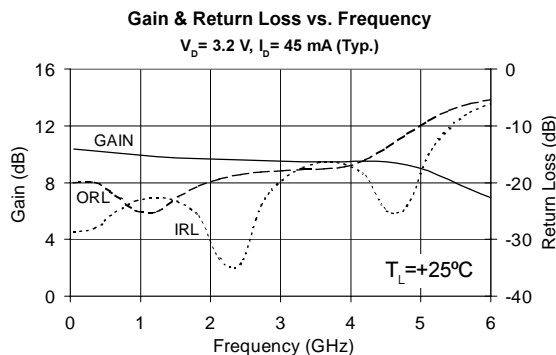

## SGA-4163

### DC-5000 MHz, Cascadable SiGe HBT MMIC Amplifier



### Product Features

- Broadband Operation: DC-5000 MHz
- Cascadable 50 Ohm
- Patented SiGe Technology
- Operates From Single Supply
- Low Thermal Resistance Package

### Applications

- PA Driver Amplifier
- Cellular, PCS, GSM, UMTS
- IF Amplifier
- Wireless Data, Satellite

| Symbol         | Parameter                             | Units                     | Frequency                       | Min. | Typ.               | Max. |
|----------------|---------------------------------------|---------------------------|---------------------------------|------|--------------------|------|
| G              | Small Signal Gain                     | dB                        | 850 MHz<br>1950 MHz<br>2400 MHz | 9.5  | 10.5<br>9.7<br>9.6 | 11.5 |
| $P_{1dB}$      | Output Power at 1dB Compression       | dBm                       | 850 MHz<br>1950 MHz             |      | 13.0<br>12.1       |      |
| $OIP_3$        | Output Third Order Intercept Point    | dBm                       | 850 MHz<br>1950 MHz             |      | 29.7<br>25.4       |      |
| Bandwidth      | Determined by Return Loss (>10dB)     | MHz                       |                                 |      | 5000               |      |
| IRL            | Input Return Loss                     | dB                        | 1950 MHz                        |      | 28.0               |      |
| ORL            | Output Return Loss                    | dB                        | 1950 MHz                        |      | 20.1               |      |
| NF             | Noise Figure                          | dB                        | 1950 MHz                        |      | 5.0                |      |
| $V_D$          | Device Operating Voltage              | V                         |                                 | 2.9  | 3.2                | 3.5  |
| $I_D$          | Device Operating Current              | mA                        |                                 | 41   | 45                 | 49   |
| $R_{TH}$ , j-I | Thermal Resistance (junction to lead) | $^\circ\text{C}/\text{W}$ |                                 |      | 255                |      |

**Test Conditions:**  $V_S = 8\text{ V}$   $I_D = 45\text{ mA Typ.}$   $OIP_3$  Tone Spacing = 1 MHz, Pout per tone = -5 dBm  
 $R_{BIAS} = 110\text{ Ohms}$   $T_L = 25^\circ\text{C}$   $Z_S = Z_L = 50\text{ Ohms}$

The information provided herein is believed to be reliable at press time. Sirenza Microdevices assumes no responsibility for inaccuracies or omissions. Sirenza Microdevices assumes no responsibility for the use of this information, and all such information shall be entirely at the user's own risk. Prices and specifications are subject to change without notice. No patent rights or licenses to any of the circuits described herein are implied or granted to any third party. Sirenza Microdevices does not authorize or warrant any Sirenza Microdevices product for use in life-support devices and/or systems. Copyright 2001 Sirenza Microdevices, Inc. All worldwide rights reserved.

## Typical RF Performance at Key Operating Frequencies

| Symbol           | Parameter                          | Unit | Frequency (MHz) |      |      |      |      |      |
|------------------|------------------------------------|------|-----------------|------|------|------|------|------|
|                  |                                    |      | 100             | 500  | 850  | 1950 | 2400 | 3500 |
| G                | Small Signal Gain                  | dB   | 10.3            | 10.2 | 10.5 | 9.7  | 9.6  | 9.4  |
| OIP <sub>3</sub> | Output Third Order Intercept Point | dBm  |                 | 30.2 | 29.7 | 25.4 | 23.0 |      |
| P <sub>1dB</sub> | Output Power at 1dB Compression    | dBm  |                 | 12.9 | 13.0 | 12.1 | 11.1 |      |
| IRL              | Input Return Loss                  | dB   | 29.1            | 26.7 | 23.7 | 28.0 | 36.7 | 16.6 |
| ORL              | Output Return Loss                 | dB   | 19.7            | 20.8 | 24.3 | 20.1 | 18.7 | 17.6 |
| S <sub>12</sub>  | Reverse Isolation                  | dB   | 15.5            | 16.0 | 16.3 | 17.2 | 17.6 | 18.4 |
| NF               | Noise Figure                       | dB   |                 | 4.6  | 4.8  | 5.0  | 5.3  |      |

**Test Conditions:**  $V_S = 8\text{ V}$ ,  $I_D = 45\text{ mA Typ.}$ , OIP<sub>3</sub> Tone Spacing = 1 MHz, Pout per tone = -5 dBm  
 $R_{BIAS} = 110\text{ Ohms}$ ,  $T_L = 25^\circ\text{C}$ ,  $Z_S = Z_L = 50\text{ Ohms}$

### Noise Figure vs. Frequency

$V_D = 3.2\text{ V}$ ,  $I_D = 45\text{ mA (Typ.)}$

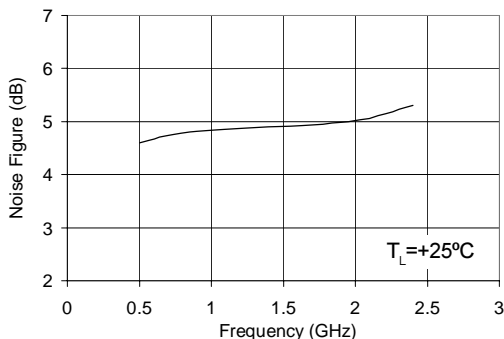

### Absolute Maximum Ratings

| Parameter                       | Absolute Limit |
|---------------------------------|----------------|
| Max. Device Current ( $I_D$ )   | 90 mA          |
| Max. Device Voltage ( $V_D$ )   | 5 V            |
| Max. RF Input Power             | +18 dBm        |
| Max. Junction Temp. ( $T_J$ )   | +150°C         |
| Operating Temp. Range ( $T_L$ ) | -40°C to +85°C |
| Max. Storage Temp.              | +150°C         |

Operation of this device beyond any one of these limits may cause permanent damage. For reliable continuous operation, the device voltage and current must not exceed the maximum operating values specified in the table on page one.

Bias conditions should also satisfy the following expression:

$$I_D V_D < (T_J - T_L) / R_{TH} \text{ J}^{-1}$$

### OIP<sub>3</sub> vs. Frequency

$V_D = 3.2\text{ V}$ ,  $I_D = 45\text{ mA (Typ.)}$

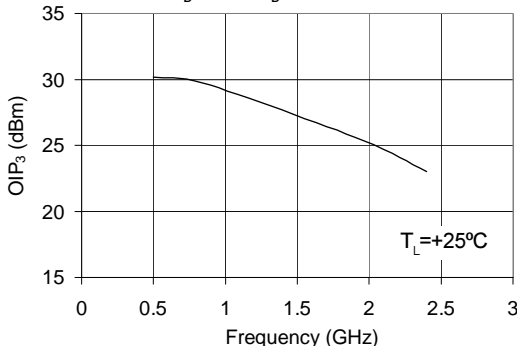

### P<sub>1dB</sub> vs. Frequency

$V_D = 3.2\text{ V}$ ,  $I_D = 45\text{ mA (Typ.)}$

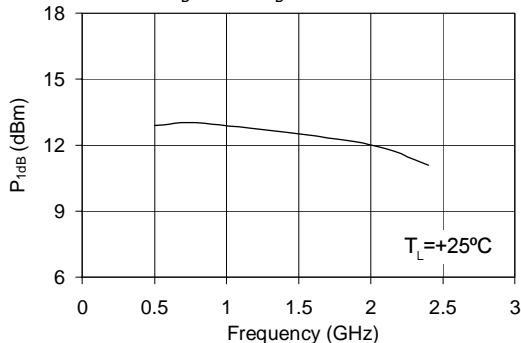

**Typical RF Performance Over Temperature ( Bias:  $V_D = 3.2$  V,  $I_D = 45$  mA (Typ.) )**

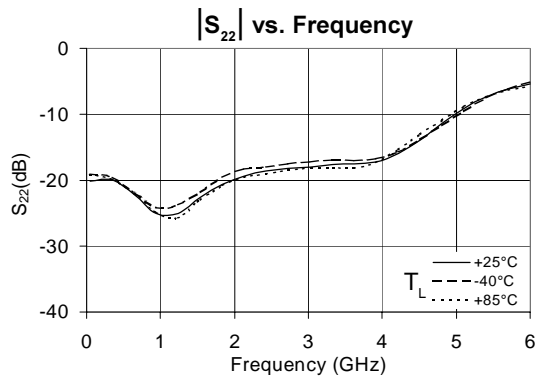
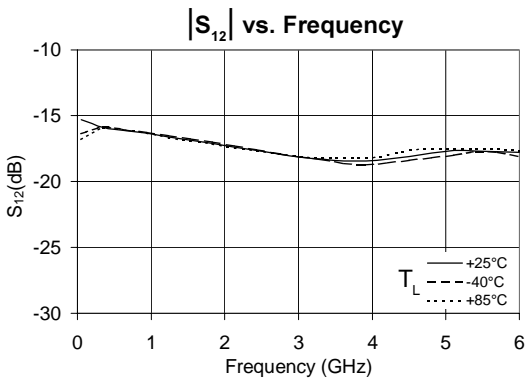
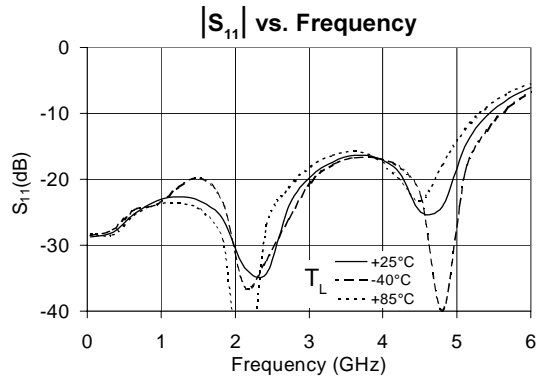
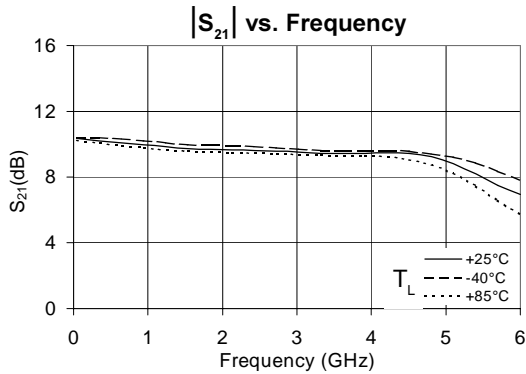

NOTE: Full S-parameter data available at [www.sirenza.com](http://www.sirenza.com)

## Basic Application Circuit

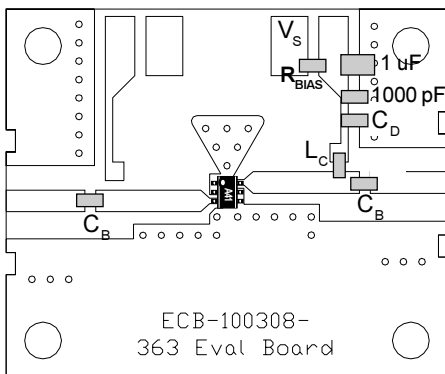
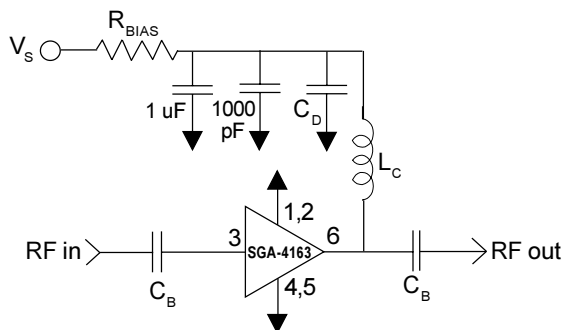

### Part Identification Marking

The part will be marked with an "A41" designator on the top surface of the package.

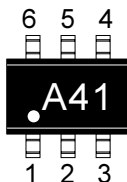

### Caution: ESD sensitive

Appropriate precautions in handling, packaging and testing devices must be observed.

### Application Circuit Element Values

| Reference Designator | Frequency (Mhz) |        |       |       |       |
|----------------------|-----------------|--------|-------|-------|-------|
|                      | 500             | 850    | 1950  | 2400  | 3500  |
| C <sub>B</sub>       | 220 pF          | 100 pF | 68 pF | 56 pF | 39 pF |
| C <sub>D</sub>       | 100 pF          | 68 pF  | 22 pF | 22 pF | 15 pF |
| L <sub>C</sub>       | 68 nH           | 33 nH  | 22 nH | 18 nH | 15 nH |

### Recommended Bias Resistor Values for I<sub>D</sub>=45mA

$$R_{BIAS} = (V_S - V_D) / I_D$$

| Supply Voltage(V <sub>S</sub> ) | 6 V  | 8 V   | 10 V  | 12 V  |
|---------------------------------|------|-------|-------|-------|
| R <sub>BIAS</sub>               | 62 Ω | 110 Ω | 150 Ω | 200 Ω |

Note: R<sub>BIAS</sub> provides DC bias stability over temperature.

### Mounting Instructions

- Use a large ground pad area near device pins 1, 2, 4, and 5 with many plated through-holes as shown.
- 
- We recommend 1 or 2 ounce copper. Measurements for this data sheet were made on a 31 mil thick FR-4 board with 1 ounce copper on both sides.

| Pin #      | Function    | Description                                                                                                                     |
|------------|-------------|---------------------------------------------------------------------------------------------------------------------------------|
| 3          | RF IN       | RF input pin. This pin requires the use of an external DC blocking capacitor chosen for the frequency of operation.             |
| 1, 2, 4, 5 | GND         | Connection to ground. For optimum RF performance, use via holes as close to ground leads as possible to reduce lead inductance. |
| 6          | RF OUT/BIAS | RF output and bias pin. DC voltage is present on this pin, therefore a DC blocking capacitor is necessary for proper operation. |

### Part Number Ordering Information

| Part Number | Reel Size | Devices/Reel |
|-------------|-----------|--------------|
| SGA-4163    | 7"        | 3000         |

**PCB Pad Layout**

Dimensions in inches [millimeters]

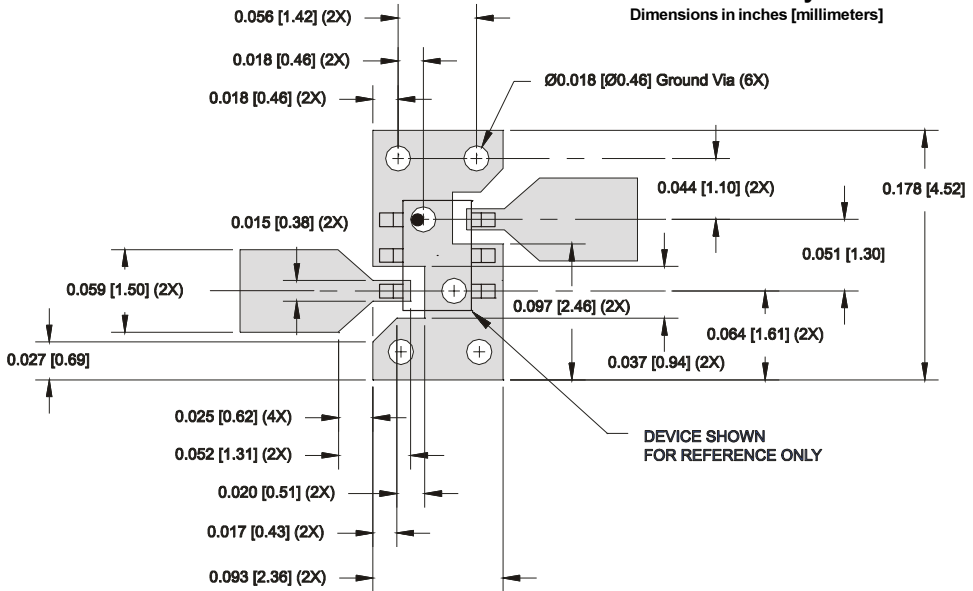

**Nominal Package Dimensions**

Dimensions in inches [millimeters]

Refer to drawing posted at [www.sirenza.com](http://www.sirenza.com) for tolerances.

