

# C&K D Series Miniature Snap-in Power Rocker Switches

## Features/Benefits

- Momentary and maintained models
- PC and quick connect terminals
- Recessed bracket available — prevents accidental actuation
- RoHS compliant

## Typical Applications

- Small appliances
- Computers and peripherals
- Medical instrumentation



Models Available

## Specifications

CONTACT RATING: D10X and D20X Models: 4 AMPS @ 125 V AC; 2 AMPS @ 250 V AC. D50X and D60X Models: 10 AMPS @ 125 V AC; 5 AMPS @ 250 V AC.

ELECTRICAL LIFE: 10,000 make-and-break cycles at full load.

INSULATION RESISTANCE:  $10^9 \Omega$  min.

DIELECTRIC STRENGTH: 1,000 Vrms min. @ sea level.

**NOTE:** For the latest information regarding RoHS compliance, please go to: [www.ittcannon.com/rohs](http://www.ittcannon.com/rohs).

**NOTE:** Specifications and materials listed above are for standard switches. For information on specific and custom switches, consult Customer Service Center.

## Materials

ACTUATOR & HOUSING: 6/6 nylon (UL 94V-2), color black, finish: matte.

MOVABLE CONTACTS: D10X and D20X Models: Copper, silver plated. D50X and D60X Models: Coin silver, silver plated.

STATIONARY CONTACTS AND TERMINALS: Copper or brass, silver plated.

CONTACT SPRING: Music wire or stainless steel.

OPERATING TEMPERATURE: -30°C to +65°C

## Build-A-Switch

To order, simply select desired option from each category and place in the appropriate box. Available options are shown and described on pages H-62 through H-66. For additional options not shown in catalog, consult Customer Service Center.

|   |  |   |  |
|---|--|---|--|
| <p><b>Switch Function</b></p> <p><b>D101</b> SPDT, On-None-On<br/> <b>D102</b> SPST, On-None-Off<br/> <b>D103</b> SPDT, On-Off-On<br/> <b>D105</b> SPDT, Mom.-Off-Mom.<br/> <b>D108</b> SPDT, Mom.-None-On<br/> <b>D201</b> DPDT, On-None-On<br/> <b>D202</b> DPST, On-None-Off<br/> <b>D203</b> DPDT, On-Off-On<br/> <b>D501</b> SPDT, On-None-On<br/> <b>D502</b> SPST, On-None-Off<br/> <b>D503</b> SPDT, On-Off-On<br/> <b>D508</b> SPDT, Mom.-None-On<br/> <b>D601</b> DPDT, On-None-On<br/> <b>D602</b> DPST, On-None-Off<br/> <b>D608</b> DPDT, Mom.-None-On</p> | <p><b>Actuator</b></p> <p><b>J1</b> Rocker<br/> <b>J5</b> Lever</p> <p><b>Actuator Color</b></p> <p><b>2</b> Black<br/> <b>1</b> White<br/> <b>3</b> Red</p> <p><b>Mounting Style/Color</b></p> <p><b>S2</b> Snap-in, black<br/> <b>B2</b> Recessed snap-in actuator guard, black<br/> <b>G2</b> Actuator guard, black<br/> <b>S1</b> Snap-in, white</p> | <p><b>Terminations</b></p> <p><b>15</b> Quick connect<br/> <b>A</b> Right angle, PC thru-hole<br/> <b>02</b> PC Thru-hole<br/> <b>05</b> Twisted quick connect<br/> <b>06</b> Extended PC thru-hole<br/> <b>17</b> Wirable quick connect</p> <p><b>Actuator Markings</b></p> <p><b>NONE</b> No marking<br/> <b>D</b> ON-OFF<br/> <b>H</b> 0  <br/> <b>N</b> Large dot<br/> <b>P</b> 0 -<br/> <b>R</b> Red rectangle on end<br/> <b>U</b> Large dot on end</p> | <p><b>Contact Material</b></p> <p><b>QA</b> Silver (UL/CSA)<br/> <b>QF</b> Silver (UL/CSA/VDE)</p> |
|---|--|---|--|



Dimensions are shown: Inch (mm)  
Specifications and dimensions subject to change



# C&K D Series Miniature Snap-in Power Rocker Switches

## SWITCH FUNCTION

| NO. POLES | MODEL NO.    | AMP RATING* | SWITCH FUNCTION |        |        | CONNECTED TERMINALS |        |        | SCHEMATIC |
|-----------|--------------|-------------|-----------------|--------|--------|---------------------|--------|--------|-----------|
|           |              |             | POS. 1          | POS. 2 | POS. 3 | POS. 1              | POS. 2 | POS. 3 |           |
| SP        | D102<br>D502 | 4<br>10     | ON              | NONE   | OFF    |                     | N/A    | OPEN   | SPST      |
|           | D101<br>D501 | 4<br>10     | ON              | NONE   | ON     | 1-1A                | OPEN   | 1-1B   | SPDT      |
|           | D103<br>D503 | 4<br>10     |                 | OFF    |        |                     |        |        |           |
|           | D105         | 4           | MOM.            | OFF    | MOM.   |                     |        |        |           |
|           | D108<br>D508 | 4<br>10     | MOM.            | NONE   | ON     |                     | N/A    |        |           |

### SPDT

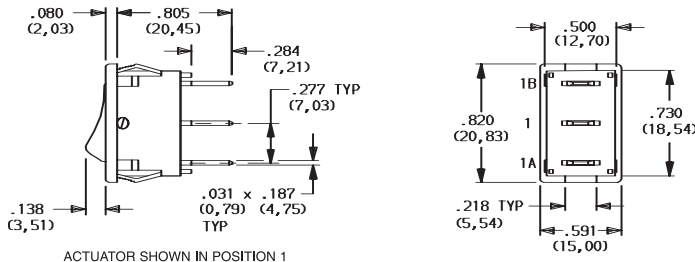

ACTUATOR SHOWN IN POSITION 1

TERMINAL NOS. FOR REF. ONLY

Part number shown: D101J12S215QA

|    |              |         |      |      |     |            |     |      |            |
|----|--------------|---------|------|------|-----|------------|-----|------|------------|
| DP | D202<br>D602 | 4<br>10 | ON   | NONE | OFF | 1-1A, 2-2A | N/A | OPEN | DPST       |
|    | D201<br>D601 | 4<br>10 | ON   | NONE | ON  |            |     | OPEN | 1-1B, 2-2B |
|    | D203         | 4       |      | OFF  |     |            |     |      |            |
|    | D608         | 10      | MOM. | NONE |     |            | N/A |      |            |

### DPDT

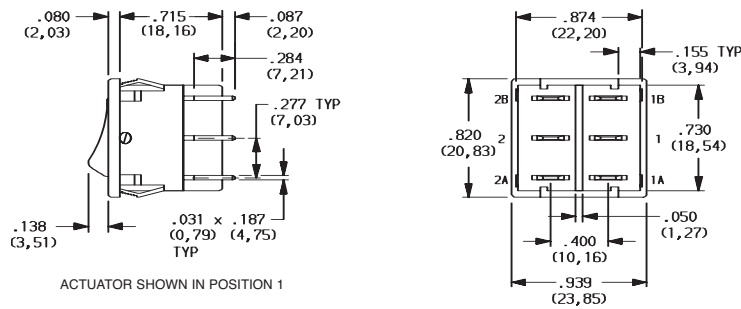

ACTUATOR SHOWN IN POSITION 1

TERMINAL NOS. FOR REF. ONLY

Part number shown: D201J12S215QA

MOM. = Momentary

\*AMP RATING: D10X and D20X models: 4 AMPS @ 125 V AC; 2 AMPS @ 250 V AC. D50X and D60X models: 10 AMPS @ 125 V AC; 5 AMPS @ 250 V AC.

All models . DX01, DX02 models also available with . See CONTACT MATERIALS, page H-68.

Rocker



H



ITT



Third Angle Projection

Dimensions are shown: Inch (mm)  
Specifications and dimensions subject to change

# C&K D Series Miniature Snap-in Power Rocker Switches



## J1 ROCKER

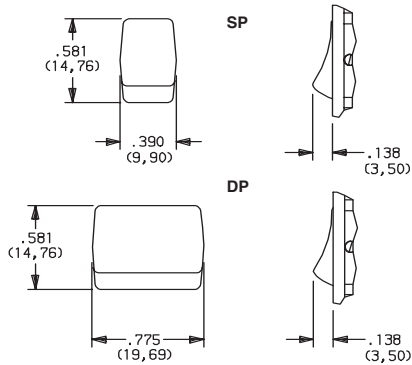

## J5 LEVER

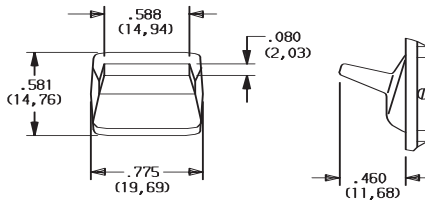

| OPTION CODE | ACTUATOR COLOR |
|-------------|----------------|
| 2           | BLACK          |
| 1           | WHITE          |
| 3           | RED            |

**NOTE:** Actuator finish: matte. Other colors available, consult Customer Service Center.

'J5' actuator available only with DP models D201, D202, D601 and D602.



## S SNAP-IN

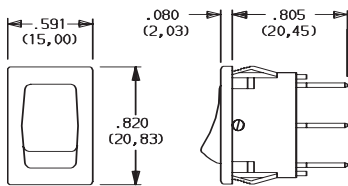

| OPTION CODE | HOUSING COLOR |
|-------------|---------------|
| 2           | (STD.) BLACK  |
| 1           | WHITE         |

**NOTE:** Frame finish on housing: matte. Other colors available, consult Customer Service Center.

## B2 RECESSED SNAP-IN ACTUATOR GUARD, BLACK

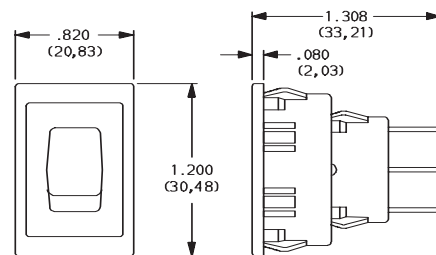

**NOTE:** Vertical mount, SP models only.

## G2 ACTUATOR GUARD, BLACK

**NEW!**

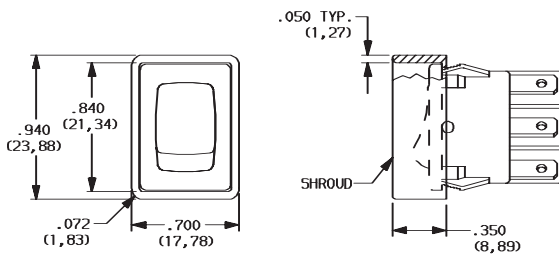

**NOTE:** Vertical mount, SP models only.

## PANEL MOUNTING

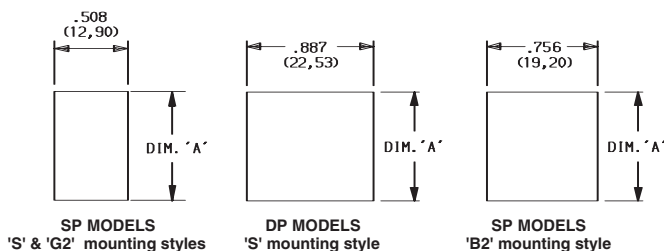

| PANEL THICKNESS         | DIM 'A' SP & DP MODELS 'S' MOUNTING STYLE | DIM 'A' WITH 'G2' OPTION SP MODELS ONLY | DIM 'A' SP MODELS 'B' MOUNTING STYLE |
|-------------------------|---|---|--------------------------------------|
| .030-.049 (0,76) (1,24) | .756 (19,20)                              | .764 (19,41)                            | 1.068 (27,13)                        |
| .049-.079 (1,24) (2,01) | .764 (19,41)                              | .780 (19,81)                            | 1.076 (27,33)                        |
| .079-.118 (2,01) (3,00) | .780 (19,81)                              | n/a                                     | 1.092 (27,74)                        |

**NOTE:** Blank insert available for SP models only, see page H-68.



Dimensions are shown: Inch (mm)  
Specifications and dimensions subject to change

Rocker



H

# C&K D Series Miniature Snap-in Power Rocker Switches

## TERMINATIONS

### A RIGHT ANGLE, PC THRU-HOLE

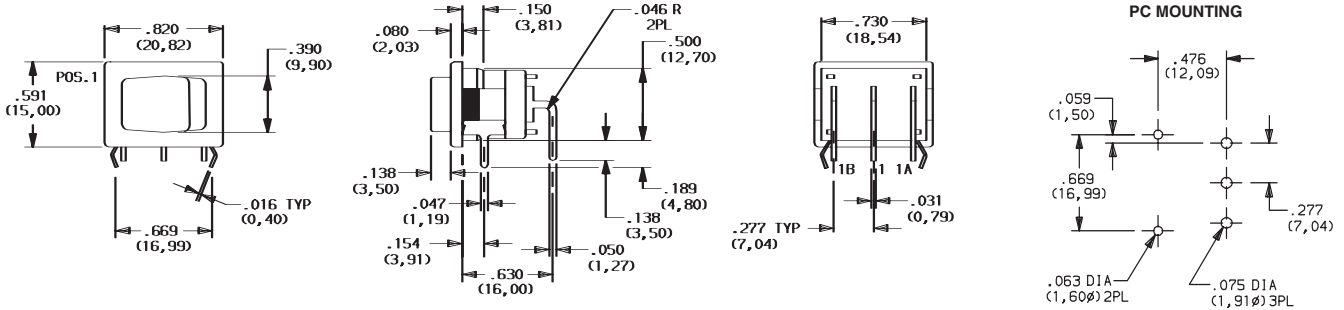

Available with D101, D102, D501, D502 SP models only.

## TERMINATIONS

### 02 PC THRU-HOLE

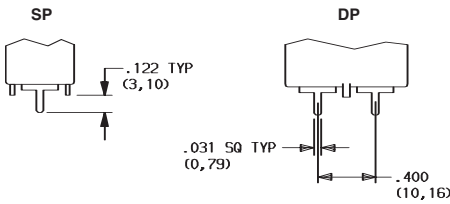

### 06 EXTENDED PC THRU-HOLE

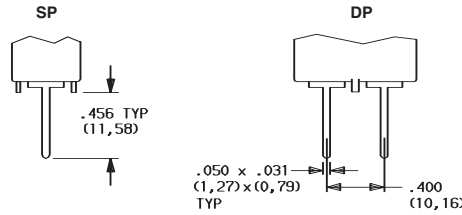

### PC MOUNTING (02 and 06)

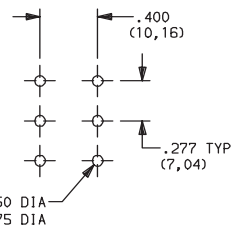

Available with DX01 and DX02 models only.

Available with DX01 and DX02 models only.

### 15 QUICK CONNECT

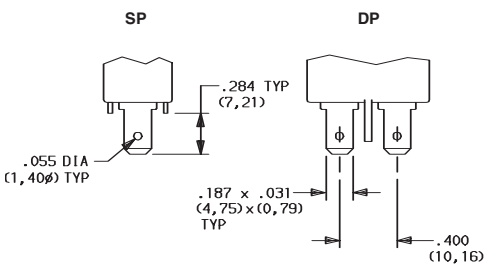

### 05 TWISTED QUICK CONNECT

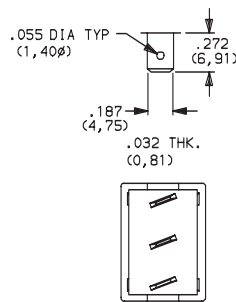

### 17 WIRABLE QUICK CONNECT

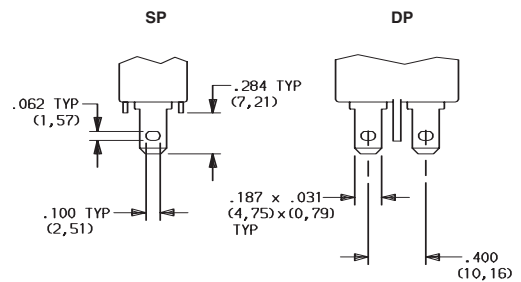

Available with DX01 and DX02 models only.

NOTE: Terminals are twisted.

Available with DX01 and DX02 models only.

## ACTUATORS

- NONE** NO MARKING
- D** ON-OFF
- H** O |
- N** LARGE DOT
- P** O -
- R** RED RECTANGLE ON END
- U** LARGE DOT ON END

Rocker

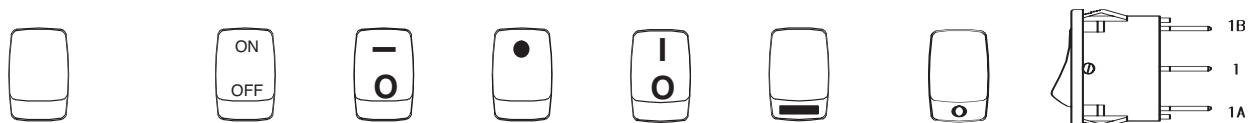

NOTE: Orientation of actuator markings and terminals.



Dimensions are shown: Inch (mm)  
Specifications and dimensions subject to change

'D, H, P & U' marking options: marking color white, standard for all actuator colors except white. Black marking color, standard for white actuators. 'R & N' marking option: red marking color, standard. Consult Customer Service Center for other available marking colors.



# C&K D Series Miniature Snap-in Power Rocker Switches





## CONTACT MATERIAL

| OPTION CODE | RoHS COMPLIANT * | RoHS COMPATIBLE * | CONTACT AND TERMINAL MATERIAL | RATINGS |  |
|-------------|------------------|-------------------|-------------------------------|---------|--|
|             |                  |                   |                               | POWER   |  |
| QA          | YES              | YES               | SILVER <sup>1</sup>           | POWER   | D10X and D20X MODELS: 4 AMPS @ 125 V AC; 2 AMPS @ 250 V AC (UL/CSA).<br>D50X and D60X MODELS: 10 AMPS @ 125 V AC; 5 AMPS @ 250 V AC (UL/CSA).  |
| QF          | YES              | YES               |                               |         | D10X and D20X MODELS: 4 AMPS @ 125 V AC; 2 AMPS @ 250 V AC (UL/CSA).<br>4(2) AMPS @ 125 V AC; 2(1) AMPS @ 250 V AC, T85 (VDE).<br>D50X and D60X MODELS: 10 AMPS @ 125 V AC; 5 AMPS @ 250 V AC (UL/CSA).<br>10(6) AMPS @ 125 V AC; 5(3) AMPS @ 250 V AC, T85 (VDE). |

<sup>1</sup>MOVABLE CONTACT: D10X and D20X MODELS: Copper, silver plated.  
D50X and D60X MODELS: Coin silver, silver plated.

STATIONARY CONTACTS & TERMINALS: Copper or brass, silver plated.

**NOTE:** For the latest information regarding RoHS compliance, please go to: [www.ittcannon.com/rohs](http://www.ittcannon.com/rohs).

All models   with all options. DX01, DX02 models    when ordered with 'QF' contact material.

## AVAILABLE HARDWARE

Insert  
SP Only

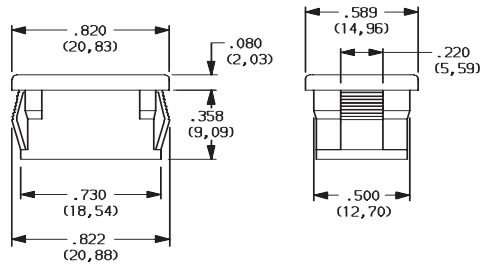

PART NO.

**057190200** BLACK

Material: Nylon 6/6  
Finish: Matte

Recessed Actuator Guard,  
SP Only



PART NO.

**057090100** BLACK

Material: 6/6 Nylon  
Finish: Matte

Actuator Guard

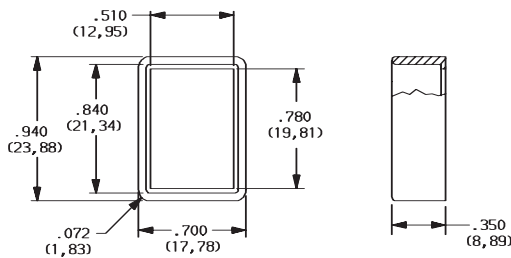

PART NO.

**104C02000**

Material: PBT thermoplastic  
Finish: Matte



Third Angle Projection

Dimensions are shown: Inch (mm)  
Specifications and dimensions subject to change

Rocker



H