

International IOR Rectifier

95SQ015

SCHOTTKY RECTIFIER

9 Amp

Major Ratings and Characteristics

Characteristics	95SQ015	Units
$I_{F(AV)}$ Rectangular waveform	9	A
V_{RRM}	15	V
I_{FSM} @ $t_p = 5 \mu s$ sine	2900	A
V_F @9 Apk, $T_J = 75^\circ C$	0.25	V
T_J range	-55 to 100	$^\circ C$

Description/Features

The 95SQ015 axial leaded Schottky rectifier has been optimized for ultra low forward voltage drop specifically for the OR-ing of parallel power supplies. The proprietary barrier technology allows for reliable operation up to 100° C junction temperature. Typical applications are in parallel switching power supplies, converters, reverse battery protection, and redundant power subsystems.

- 125° C T_J operation ($V_R < 5V$)
- Optimized for OR-ing applications
- Ultra low forward voltage drop
- High frequency operation
- Guard ring for enhanced ruggedness and long term reliability
- High purity, high temperature epoxy encapsulation for enhanced mechanical strength and moisture resistance

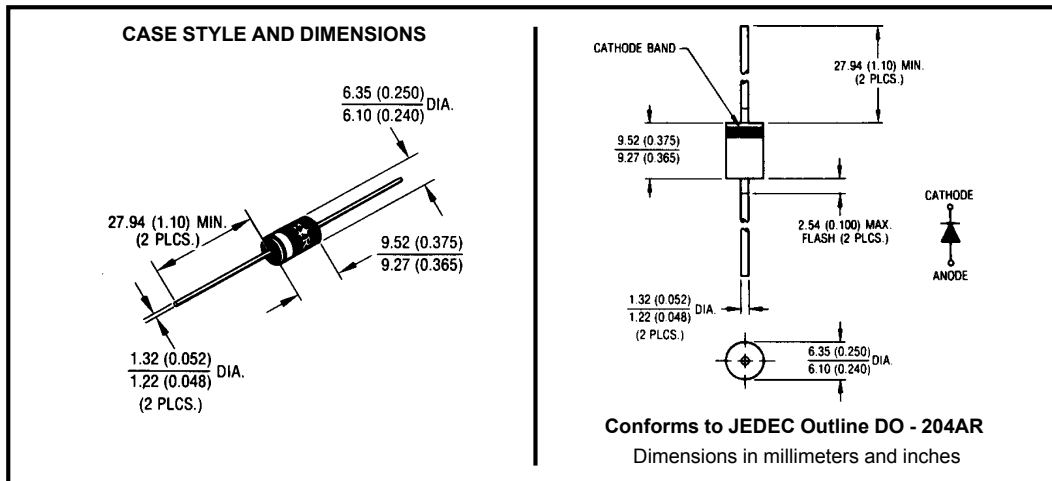

Voltage Ratings

Part number	95SQ015
V_R Max. DC Reverse Voltage (V)	15
V_{RWM} Max. Working Peak Reverse Voltage (V)	25

Absolute Maximum Ratings

Parameters	95SQ	Units	Conditions
$I_{F(AV)}$ Max. Average Forward Current * See Fig. 5	9	A	50% duty cycle @ $T_C = 55^\circ\text{C}$, rectangular wave form
I_{FSM} Max. Peak One Cycle Non-Repetitive Surge Current * See Fig. 7	2900	A	5 μs Sine or 3 μs Rect. pulse
	400		10ms Sine or 6ms Rect. pulse
E_{AS} Non-Repetitive Avalanche Energy	4.50	mJ	$T_J = 25^\circ\text{C}$, $I_{AS} = 1$ Amps, $L = 9$ mH
I_{AR} Repetitive Avalanche Current	1	A	Current decaying linearly to zero in 1 μsec Frequency limited by T_J max. $V_A = 3 \times V_R$ typical

Electrical Specifications

Parameters	95SQ	Units	Conditions
V_{FM} Max. Forward Voltage Drop (1) * See Fig. 1	0.31	V	@ 9A
	0.37	V	@ 18A
	0.25	V	@ 9A
	0.31	V	@ 18A
I_{RM} Max. Reverse Leakage Current (1) * See Fig. 2	7	mA	$T_J = 25^\circ\text{C}$
	348	mA	$T_J = 100^\circ\text{C}$
	310	mA	$T_J = 100^\circ\text{C}$
	190	mA	$T_J = 100^\circ\text{C}$
C_T Max. Junction Capacitance	1300	pF	$V_R = 5V_{DC}$, (test signal range 100Khz to 1Mhz) 25°C
L_S Typical Series Inductance	10.0	nH	Measured lead to lead 5mm from body
dv/dt Max. Voltage Rate of Change (Rated V_R)	10000	V/ μs	

(1) Pulse Width < 300 μs , Duty Cycle < 2%

Thermal-Mechanical Specifications

Parameters	95SQ	Units	Conditions
T_J Max. Junction Temperature Range	-55 to 125	$^\circ\text{C}$	
T_{stg} Max. Storage Temperature Range	-55 to 150	$^\circ\text{C}$	
R_{thJL} Max. Thermal Resistance Junction to Lead	8.0	$^\circ\text{C}/\text{W}$	DC operation * See Fig. 4 1/8 inch lead length
R_{thJA} Typical Thermal Resistance, Junction to Air	44	$^\circ\text{C}/\text{W}$	
wt Approximate Weight	1.4(0.049)	g(oz.)	
Case Style	DO-204AR	JEDEC	

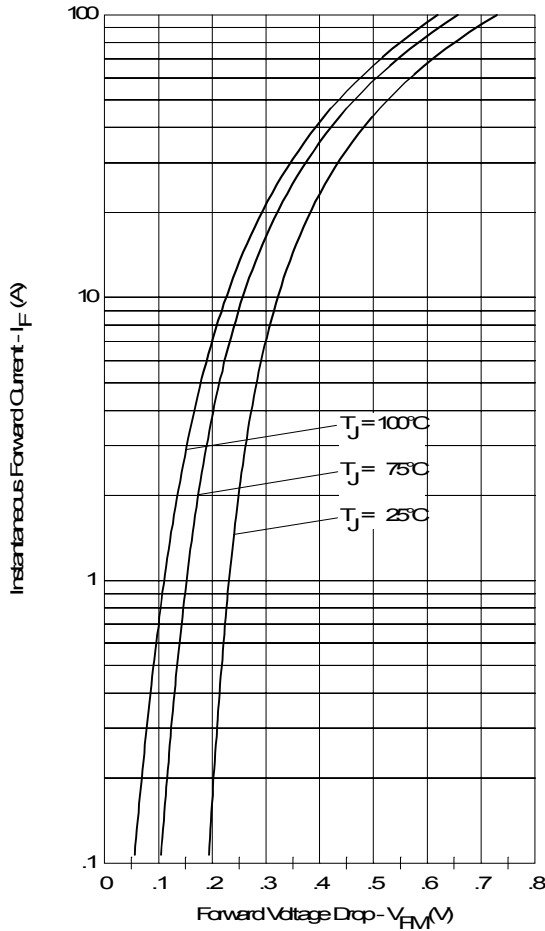

Fig. 1 - Maximum Forward Voltage Drop Characteristics

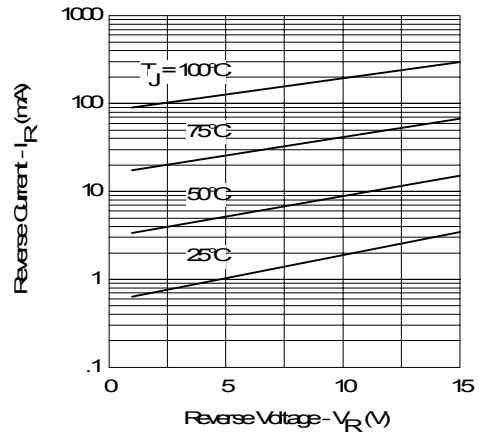

Fig. 2 - Typical Values of Reverse Current Vs. Reverse Voltage

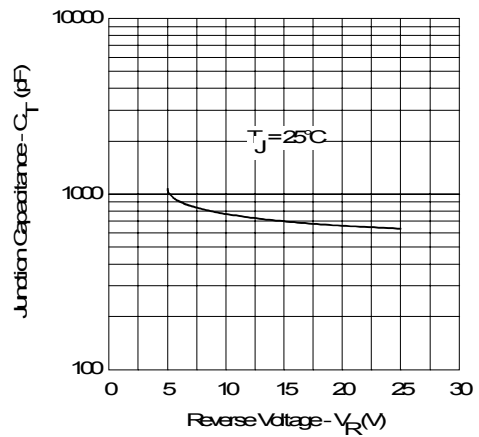

Fig. 3 - Typical Junction Capacitance Vs. Reverse Voltage

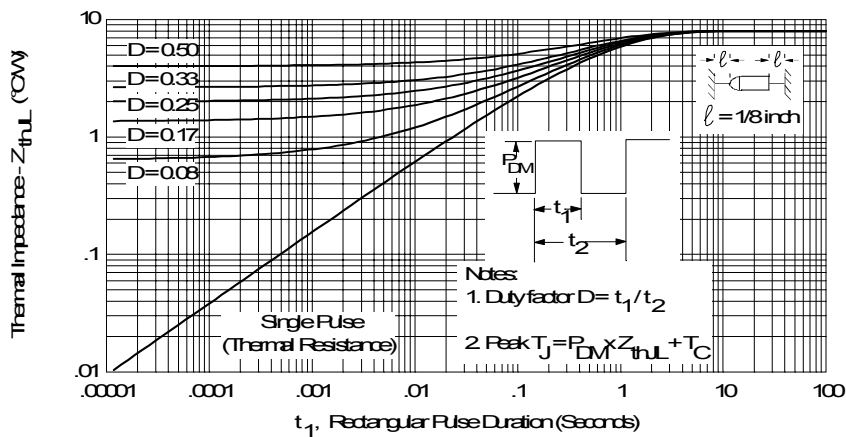

Fig. 4 - Maximum Thermal Impedance Z_{thL} Characteristics

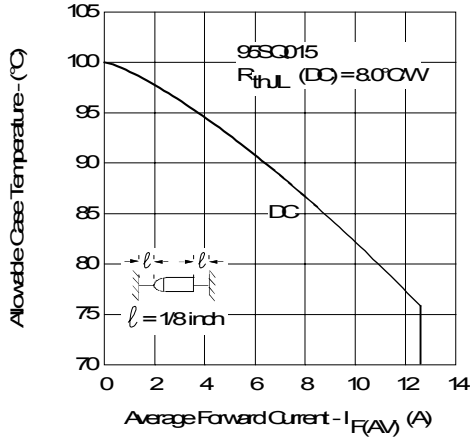

Fig. 5 - Maximum Allowable Case Temperature Vs. Average Forward Current

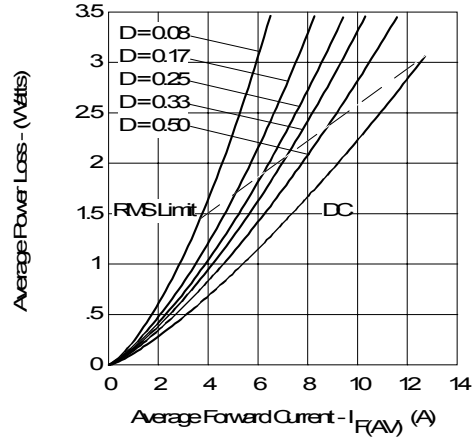

Fig. 6 - Forward Power Loss Characteristics

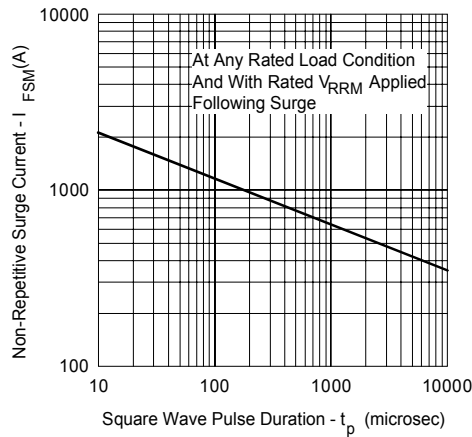

Fig. 7 - Maximum Non-Repetitive Surge Current

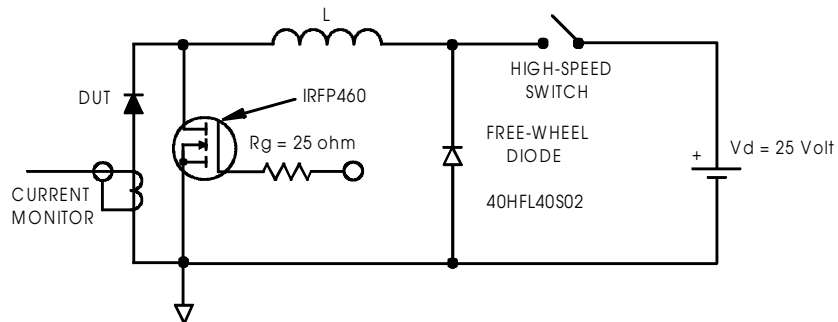

Fig. 8 - Unclamped Inductive Test Circuit

Ordering Information Table

Device Code	
95	S
Q	015
TR	
①	②
③	④
⑤	

1	-	95 = current x 10
2	-	S = DO-204AR
3	-	Q = Schottky Q Series
4	-	Voltage Rating (15V)
5	-	TR = Tape & Reel package (1500 pcs)
	-	= Box package (200 pcs)

Data and specifications subject to change without notice.
This product has been designed and qualified for Industrial Level.
Qualification Standards can be found on IR's Web site.