

# MOSFET MODULE Dual 140A/500V

# PDM1405HA

## FEATURES

- \* Dual MOSFETs Cascaded Circuit
- \* Prevented Body Diodes of MOSFETs by SBDs, and Ultra Fast Recovery Diodes Connected in Parallel
- \* 300KHz High Speed Switching Possible

## TYPICAL APPLICATIONS

- \* Power Supply for the Communications and the Induction Heating

## OUTLINE DRAWING

Dimension(mm)

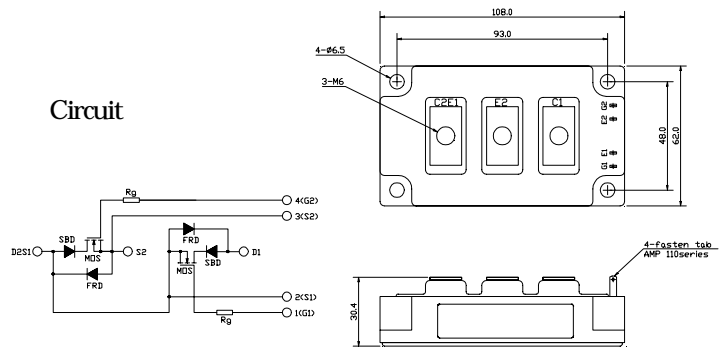

Approximate Weight : 460g

## MAXMUM RATINGS

Ratings		Symbol	PDM1405HA	Unit
Drain-Source Voltage ( $V_{GS}=0V$ )		$V_{DSS}$	500	V
Gate - Source Voltage		$V_{GSS}$	+/- 20	V
Continuous Drain Current	Duty=50%	$I_D$	140 ( $T_C=25^\circ C$ )	A
	D.C.		100 ( $T_C=25^\circ C$ )	
Pulsed Drain Current		$I_{DM}$	280 ( $T_C=25^\circ C$ )	A
Total Power Dissipation		$P_D$	880 ( $T_C=25^\circ C$ )	W
Operating Junction Temperature Range		$T_{jw}$	-40 to +150	$^\circ C$
Storage Temperature Range		$T_{stg}$	-40 to +125	$^\circ C$
Isolation Voltage Terminals to Base AC, 1 min.)		$V_{ISO}$	2000	V
Mounting Torque	Module Base to Heatsink	$F_{TOR}$	3.0	N•m
	Bus Bar to Main Terminals		2.0	

## ELECTRICAL CHARACTERISTICS (@ $T_C=25^\circ C$ unless otherwise noted)

Characteristic	Symbol	Test Condition	Min.	Typ.	Max.	Unit
Zero Gate Voltage Drain Current	$I_{DSS}$	$V_{DS}=V_{DSS}, V_{GS}=0V$	-	-	2.0	mA
		$T_J=125^\circ C, V_{DS}=0.8V_{DSS}, V_{GS}=0V$	-	-	8.0	
Gate-Source Threshold Voltage	$V_{GS(th)}$	$V_{DS}=V_{GS}, I_D=3mA$	2.0	3.1	4.0	V
Gate-Source Leakage Current	$I_{GSS}$	$V_{GS}=\pm 20V, V_{DS}=0V$	-	-	1.0	$\mu A$
Static Drain-Source On-Resistance	$r_{DS(on)}$	$V_{GS}=10V, I_D=70A$	-	35	40	m-ohm
Drain-Source On-Voltage	$V_{DS(on)}$	$V_{GS}=10V, I_D=70A$	-	3.0	3.4	V
Forward Transconductance	$g_{fs}$	$V_{DS}=15V, I_D=70A$	-	100	-	S
Input Capacitance	$C_{ies}$	$V_{DS}=25V, V_{GS}=0V, f=1MHz$	-	28	-	nF
Output Capacitance	$C_{oss}$		-	3.6	-	nF
Reverse Transfer Capacitance	$C_{iss}$		-	0.8	-	nF
Turn-On Delay Time	$t_{d(on)}$	$V_{DD}=1/2V_{DSS}$	-	300	-	ns
Rise Time	$t_r$	$I_D=70A$	-	420	-	
Turn-Off Delay Time	$t_{d(off)}$	$V_{GS}=-5V, +10V$	-	810	-	
Fall Time	$t_f$	$R_C=5\text{ ohm}$	-	200	-	

## FREE WHEELING DIODES RATINGS & CHARACTERISTICS ( $T_C=25^\circ C$ )

Characteristic	Symbol	Test Condition	Min.	Typ.	Max.	Unit
Continuous Source Current	$I_S$	D.C.	-	-	100	A
Pulsed Source Current	$I_{SM}$	-	-	-	280	A
Diode Forward Voltage	$V_{SD}$	$I_S=140A$	-	-	1.7	V
Reverse Recovery Time	$t_{rr}$	$I_S=140A, -dis/dt=100A/\mu s$	-	130	-	ns
Reverse Recovery	$Q_r$		-	0.3	-	$\mu C$

## THERMAL CHARACTERISTICS

Characteristic	Symbol	Test Condition	Min.	Typ.	Max.	Unit
Thermal Resistance, Junction to Case	$R_{th(j-c)}$	MOS FET	-	-	0.142	$^\circ C/W$
		Diode	-	-	1.0	
Thermal Resistance, Case to Heatsink	$R_{th(c-h)}$	Mounting surface flat, smooth, and greased	-	-	0.05	

**PDM1405HA**

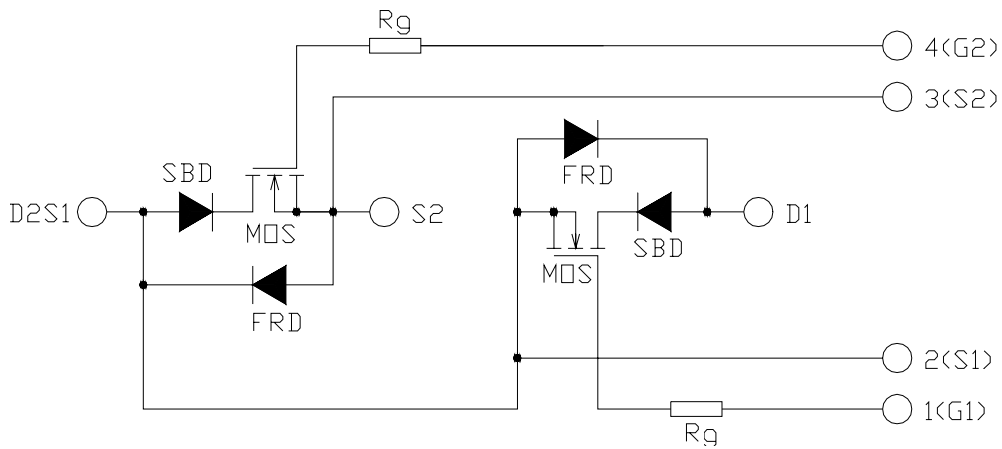
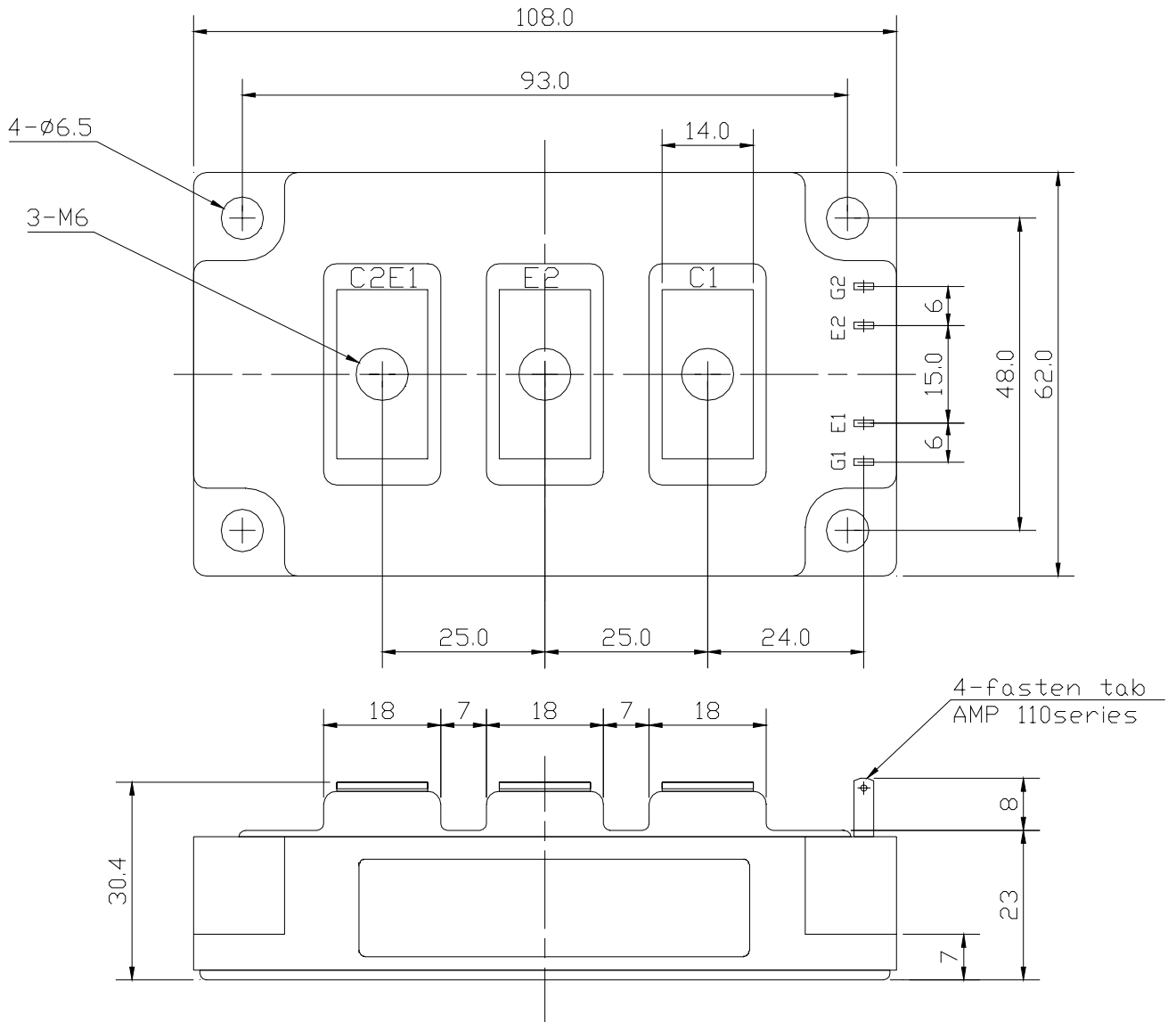

Fig. 1 Typical Output Characteristics

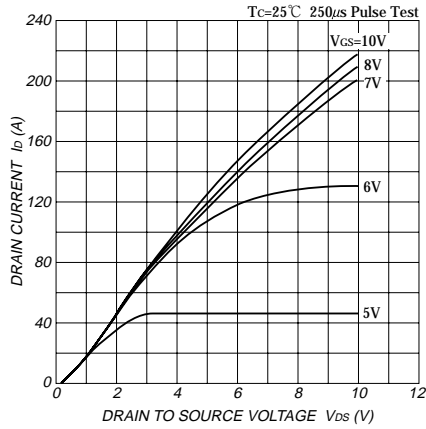

Fig. 4 Typical Capacitance Vs. Drain-Source Voltage

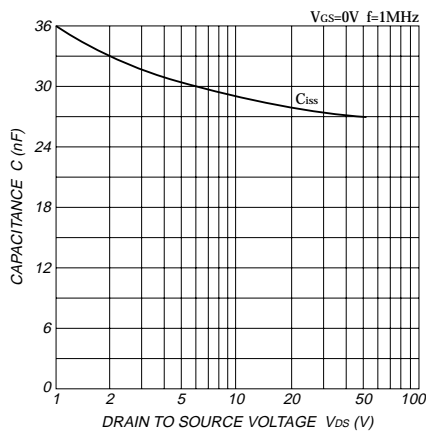

Fig. 7 Typical Switching Time Vs. Drain Current

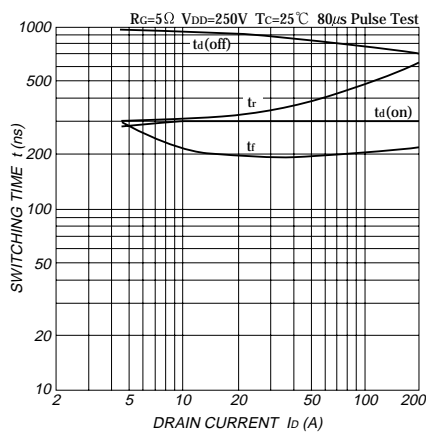

Fig. 10 Maximum Safe Operating Area

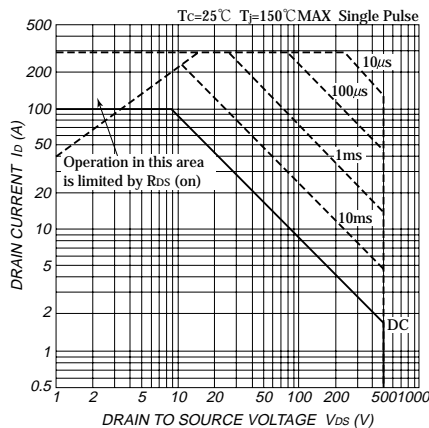

Fig. 2 Typical Drain-Source On-Voltage Vs. Gate-Source Voltage

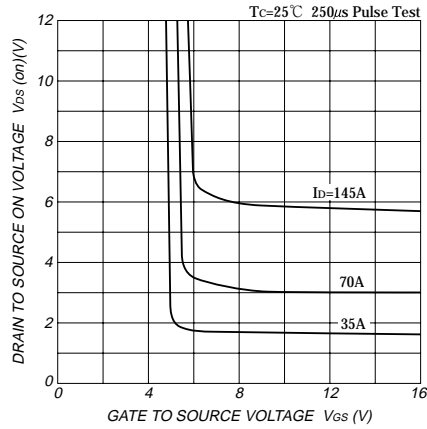

Fig. 5 Typical Gate Charge Vs. Gate-Source Voltage

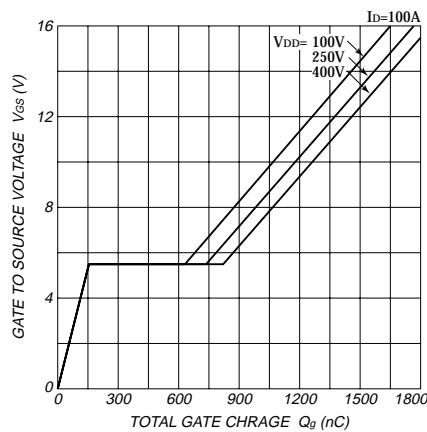

Fig. 8 Typical Source-Drain Diode Forward Characteristics

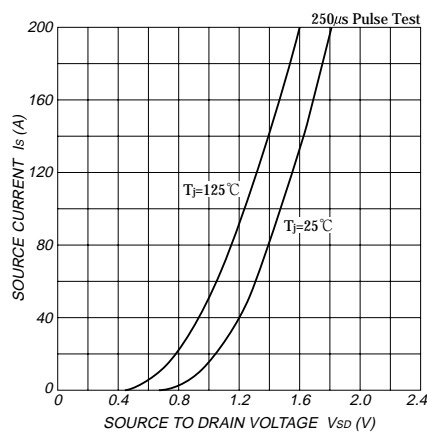

Fig. 11-1 Normalized Transient Thermal impedance(MOSFET)

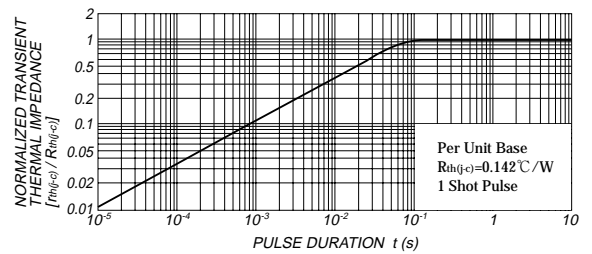

Fig. 11-2 Normalized Transient Thermal impedance(DIODE)

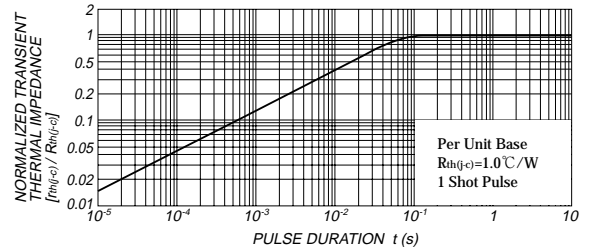

Fig. 3 Typical Drain-Source On Voltage Vs. Junction Temperature

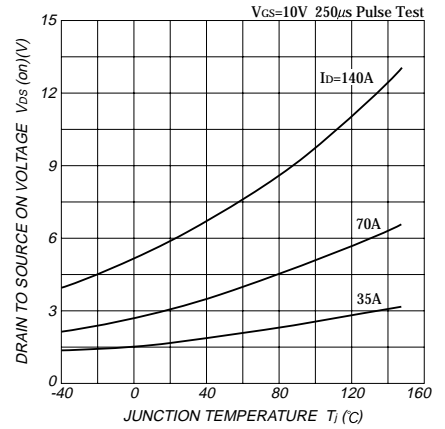

Fig. 6 Typical Switching Time Vs. Series Gate impedance

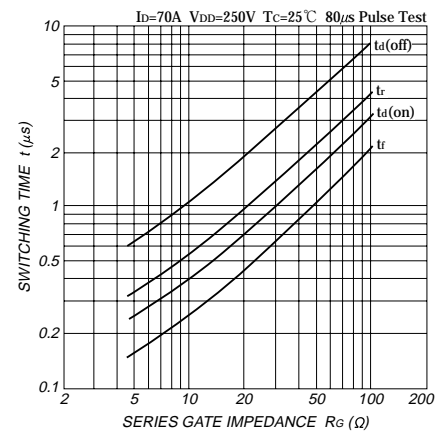
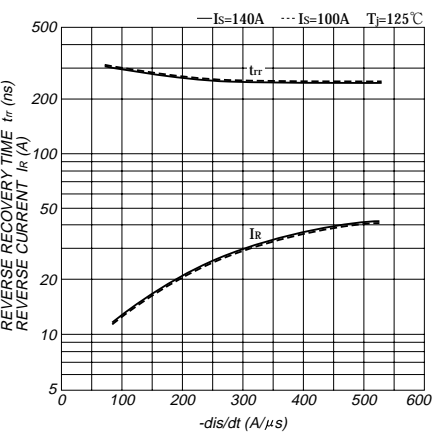

Fig. 9 Typical Reverse Recovery Characteristics



MOSFET