

FEATURES

- Outstanding Linearity
- Low V_{OS} over Temperature..... 55 μ V Max
- Excellent V_{OS} Drift..... 0.6 μ V/ $^{\circ}$ C Max
- Ultra High Gain.....5000V/mV Min
- High PSRR.....3 μ V/V Max
- Low Power Consumption.....60mW Max

APPLICATIONS

- High-Gain Instrumentation
- Precision Data Acquisition
- Precision Integrators
- Precision Threshold Detectors
- Biomedical Amplifiers

GENERAL DESCRIPTION

The AMSOP-77 is a precision operational amplifier with an ultra low input offset voltage. This device features a wide input voltage range of $\pm 13V$ minimum, low input bias current, high impedance, high PSRR, high CMRR, excellent stability of offsets and gain over time and temperature. Exceptional gain linearity eliminates incorrectable system nonlinearities common in previous monolithic op amps, and provides superior performance in high closed-loop gain applications.

Low cost, low noise, low offsets and high open-loop gain make the AMSOP-77 an excellent choice particularly for high-gain instrumentation applications. Other applications include precision data acquisition, precision integrators, threshold detectors and medical instrumentation.

The AMSOP-77 is operational in the commercial temperature range of $0^{\circ}C$ to $70^{\circ}C$ and is available in the 8 lead SOIC and plastic dip (PDIP) packages.

ORDERING INFORMATION:

TOL.	PACKAGE TYPE		OPERATING TEMPERATURE RANGE
	8 LEAD SOIC	8 LEAD PDIP	
$\pm 25\mu V$	AMSOP-77ES	AMSOP-77EP	0 to $70^{\circ}C$
$\pm 60\mu V$	AMSOP-77FS	AMSOP-77FP	0 to $70^{\circ}C$
$\pm 100\mu V$	AMSOP-77GS	AMSOP-77GP	0 to $70^{\circ}C$

PIN CONNECTIONS

8 Lead SOIC/ 8Lead PDIP

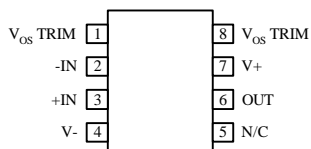

Top View

AMSOP-77

ABSOLUTE MAXIMUM RATINGS (Note1)

Supply Voltage	±22V	Storage temperature	-65°C to +125°C
Differential Input Voltage	±30V	Junction Temperature	+150°C
Input Voltage	±22V	Soldering information (60 sec)	300°C
Output Short Circuit Duration	Indefinite	Thermal Resistance	
Operating Temperature Range	0°C to 70°C	8 L SOIC	158°C/W
		8 L PDIP	103°C/W

ELECTRICAL CHARACTERISTICS

Electrical Characteristics at $V_{IN} = \pm 15V$ and $T_A = +25^\circ C$ unless otherwise specified.

Parameter	Conditions	AMSOP-77E			AMSOP-77F			AMSOP-77G			Units
		Min	Typ	Max	Min	Typ	Max	Min	Typ	Max	
Input Offset Voltage			10	25		20	60		50	100	μV
Long Term V_{OS} Stability	(Note 2)		0.3			0.4			0.4		$\mu V/Mo$
Input Offset Current			0.3	1.5		0.3	2.8		0.3	2.8	nA
Input Bias Current		-0.2	1.2	2.0	-0.2	1.2	2.8	-0.2	1.2	2.8	nA
Input Noise Voltage	0.1Hz to 10Hz		0.35	0.6		0.38	0.65		0.38	0.65	μV_{P-P}
Input Noise Voltage Density	$f_o = 10Hz$ $f_o = 100Hz$ (Note 3) $f_o = 1000Hz$		10.3 10.0 9.6	18.0 13.0 11.0		10.5 10.2 9.8	20.0 13.5 11.5		10.5 10.3 9.8	20.0 13.5 11.5	nV/\sqrt{Hz}
Input Noise Current	0.1Hz to 10Hz		14	30		15	35		15	35	pA_{P-P}
Input Noise Current Density	$f_o = 10Hz$ $f_o = 100Hz$ (Note 3) $f_o = 1000Hz$		0.32 0.14 0.12	0.80 0.23 0.17		0.35 0.15 0.13	0.90 0.27 0.18		0.35 0.15 0.13	0.90 0.27 0.18	pA/\sqrt{Hz}
Input Resistance Differential-Mode	(Note 4)	26	45		18.5	45		18.5	45		$M\Omega$
Input Resistance Common-Mode			200			200			200		$G\Omega$
Input Voltage Range		± 13	± 14		± 13	± 14		± 13	± 14		V
Common-Mode Rejection Ratio	$V_{CM} = \pm 13$		0.1	1.0		0.1	1.6		0.1	1.6	$\mu V/V$
Power Supply Rejection Ratio	$V_S = \pm 13$ to ± 18		0.7	3.0		0.7	3.0		0.7	3.0	$\mu V/V$
Large-Signal Voltage Gain	$R_L \geq 2k\Omega$, $V_O = \pm 10V$	5000	12000		2000	6000		2000	6000		V/mV
Output Voltage Swing	$R_L \geq 10k\Omega$ $R_L \geq 2k\Omega$ $R_L \geq 1k\Omega$	± 13.5 ± 12.5 ± 12.0	± 14.0 ± 13.0 ± 12.5		± 13.5 ± 12.5 ± 12.0	± 14.0 ± 13.0 ± 12.5		± 13.5 ± 12.5 ± 12.0	± 14.0 ± 13.0 ± 12.5		V
Slew Rate	$R_L \geq 2k\Omega$ (Note 3)	0.1	0.3		0.1	0.3		0.1	0.3		V/ μs
Closed-Loop Bandwidth	$A_{VCL} = +1$ (Note 3)	0.4	0.6		0.4	0.6		0.4	0.6		MHz
Open-Loop Output Resistance	$V_O = 0$, $I_O = 0$		60			60			60		Ω
Power Consumption	$V_S = \pm 15V$, No Load $V_S = \pm 3V$, No Load		50 3.5	60 4.5		50 3.5	60 4.5		50 3.5	60 4.5	mW
Offset Adjustment Range	$R_P = 20k\Omega$		± 3			± 3			± 3		mV

ELECTRICAL CHARACTERISTICS

Electrical Characteristics at $V_{IN} = \pm 15V$, $0^\circ C \leq T_A \leq +70^\circ C$ unless otherwise specified.

Parameter	Conditions	AMSOP-77E			AMSOP-77F			AMSOP-77G			Units
		Min	Typ	Max	Min	Typ	Max	Min	Typ	Max	
Input Offset Voltage			10	55		20	100		80	150	μV
Average Input Offset Voltage Drift	(Note 3)		0.3	0.6		0.4	1.0		0.7	1.2	$\mu V/^\circ C$
Input Offset Current			0.5	2.2		0.5	4.5		0.5	4.5	nA
Average Input Offset Current Drift	(Note 5)		1.5	40		1.5	85		1.5	85	$pA/^\circ C$
Input Bias Current		-0.2	2.4	4.0	-0.2	2.4	6.0	-0.2	2.4	6.0	nA
Average Input Bias Current Drift	(Note 5)		8	40		15	60		15	60	$pA/^\circ C$
Input Voltage Range		± 13.0	± 13.5		± 13.0	± 13.5		± 13.0	± 13.5		V
Common-Mode Rejection Ratio	$V_{CM} = \pm 13$		0.1	1.0		0.1	3.0		0.1	3.0	$\mu V/V$
Power Supply Rejection Ratio	$V_S = \pm 13$ to ± 18		1.0	3.0		1.0	5.0		1.0	5.0	$\mu V/V$
Large-Signal Voltage Gain	$R_L \geq 2k\Omega$, $V_O = \pm 10V$	2000	6000		1000	4000		1000	4000		V/mV
Output Voltage Swing	$R_L \geq 2k\Omega$	± 12.0	± 13.0		± 12.0	± 13.0		± 12.0	± 13.0		V
Power Consumption	$V_S = \pm 15V$, No Load		60	75		60	75		60	75	mW

Note 1: Absolute Maximum Ratings indicate limits beyond which damage to the device may occur. Operating Ratings indicate conditions for which the device is intended to be functional, but do not guarantee specific performance limits. For guaranteed specifications and test conditions, see the Electrical Characteristics. The guaranteed specifications apply only for the test conditions listed.

Note 2: Long-Term Input Offset Voltage Stability refers to the averaged trend line of VOS vs. Time over extended periods after the first 30 days of operation. Excluding the initial hour of operation, changes in V_{OS} during the first 30 operating days are typically $2.5\mu V$. Parameter is sample tested.

Note 3: Sample tested

Note 4: Guaranteed by design.

Note 5: Guaranteed by end-point limits.

TYPICAL PERFORMANCE CHARACTERISTICS

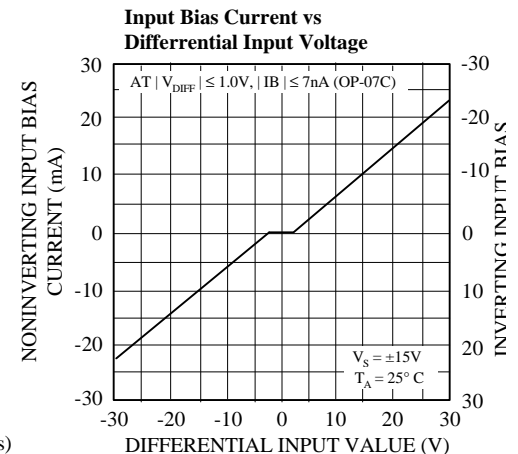
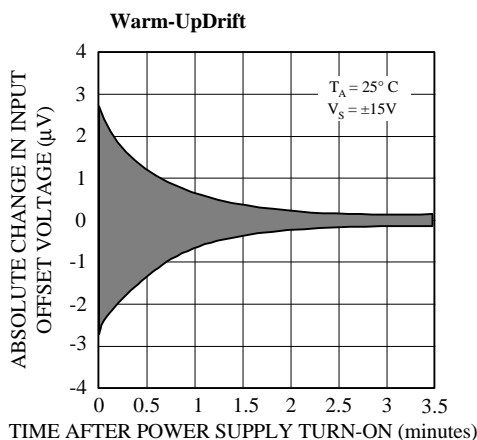
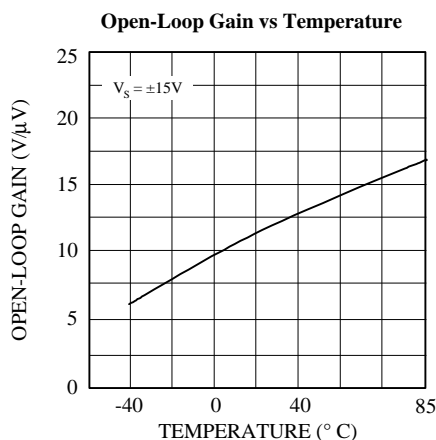

TYPICAL PERFORMANCE CHARACTERISTICS (Continued)

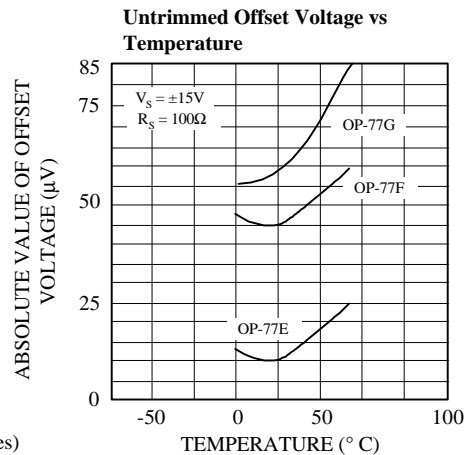
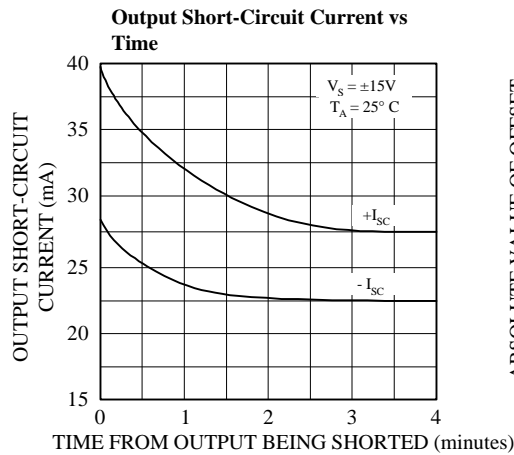
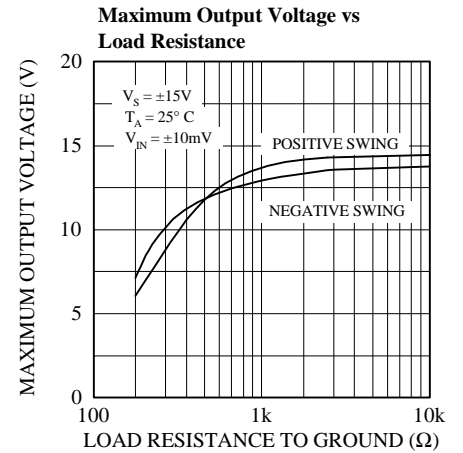
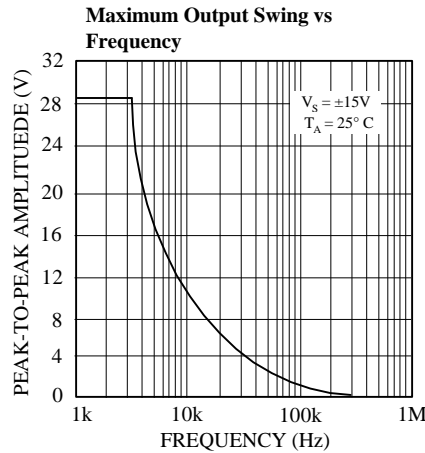
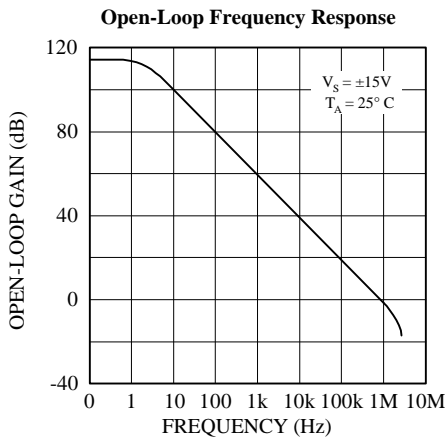
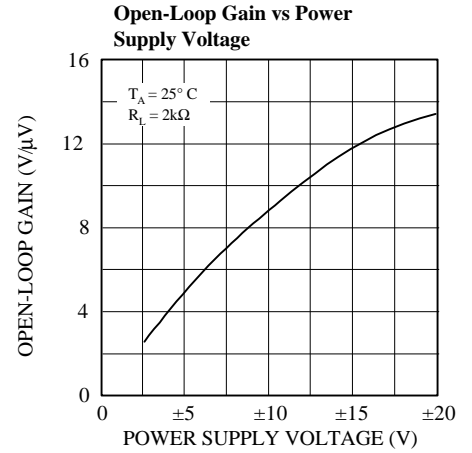
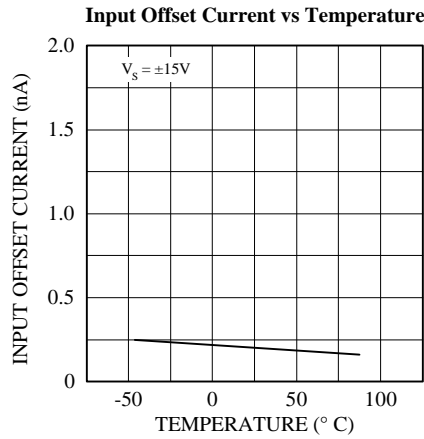
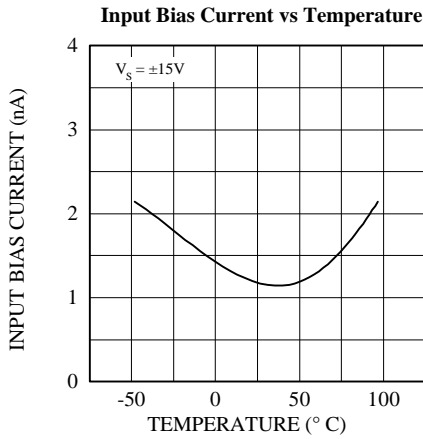

TYPICAL APPLICATIONS

Precision High-Gain Differential Amplifier

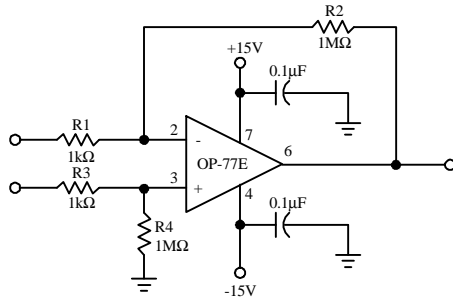

The high gain, gain linearity, CMRR, low TCV_{OS} of the OP-77 make it possible to obtain performance not previously available in single stage very high-gain amplifier applications.

For the best CMR, $\frac{R1}{R2}$ must equal $\frac{R3}{R4}$. In this example, with a 10mV differential signal, the maximum errors are as listed.

TYPE	AMOUNT
COMMON-MODE VOLTAGE	0.01%/V
GAIN LINEARITY, WORST CASE	0.02%
TCV_{OS}	0.008%/°C
TCI_{OS}	0.008%/°C

Basic Current Source

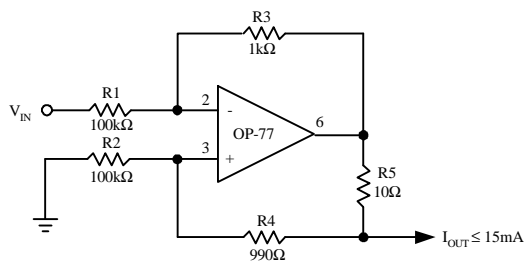

Bilateral Current Source

100mA current Source

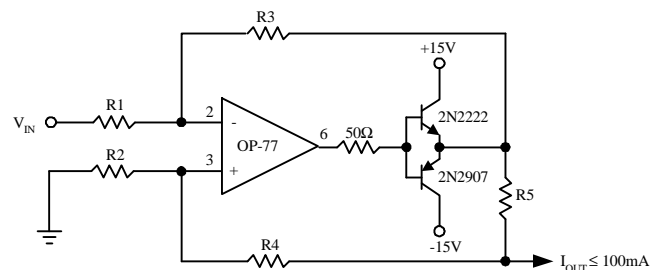

$$I_{OUT} = V_{IN} \frac{R3}{R1 + R5}$$

GIVEN $R3 = R4 + R5$, $R1 = R2$

These current sources will supply both positive and negative current into a grounded load.

Note that $Z_O = \frac{R5 \left(\frac{R4}{R2} + 1 \right)}{\frac{R5 + R4}{R2} - \frac{R3}{R1}}$ and that for Z_O to be indefinite, $\frac{R5 + R4}{R2}$ must = $\frac{R3}{R1}$.

TYPICAL APPLICATIONS (Continued)

Positive Current Sink

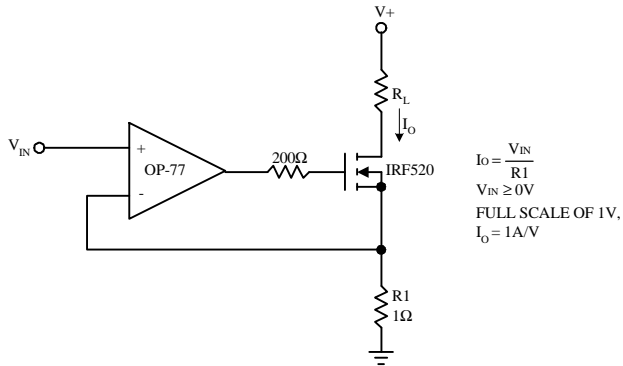

Precision Current Sinks

Positive current Source

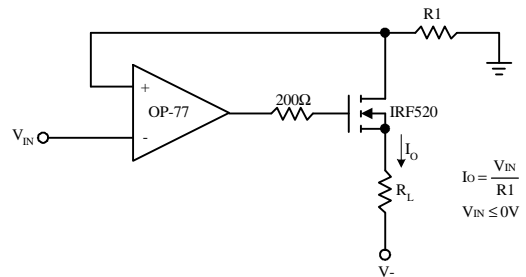

These simple high current sinks require that the load float between the power supply and the sink. In these circuits, OP-77's high gain, high CMRR, and low TC_{VOS} assure high accuracy.

Precision Absolute Value Amplifier

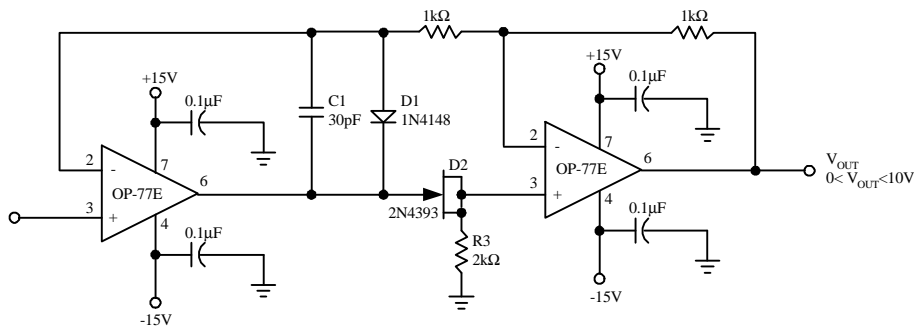

The high gain and low TC_{VOS} assure accurate operation with inputs from microvolts to volts. In this circuit, this signal always appears as a common-mode signal to the op amps. The OP-77E CMRR of 1μV/V assures errors of less than 2ppm.

Low Noise Precision Reference

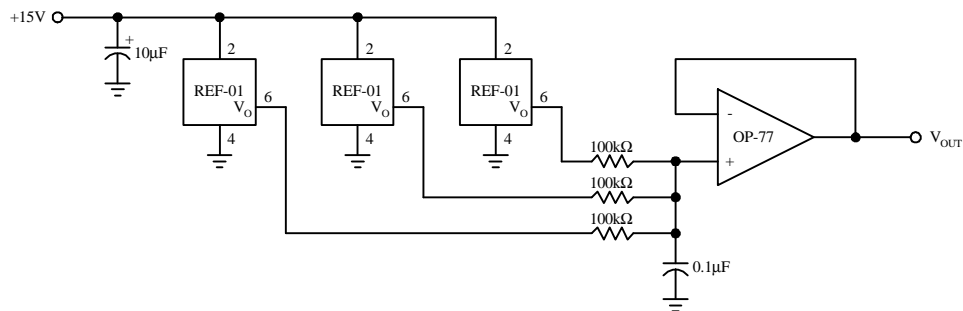

This circuit relies upon OP-77's low TC_{VOS} and noise combined with very high CMRR, to provide precision buffering of the averaged REF-01 voltage outputs.

PACKAGE DIMENSIONS inches (millimeters) unless otherwise noted.

8 LEAD SOIC PLASTIC PACKAGE (S)

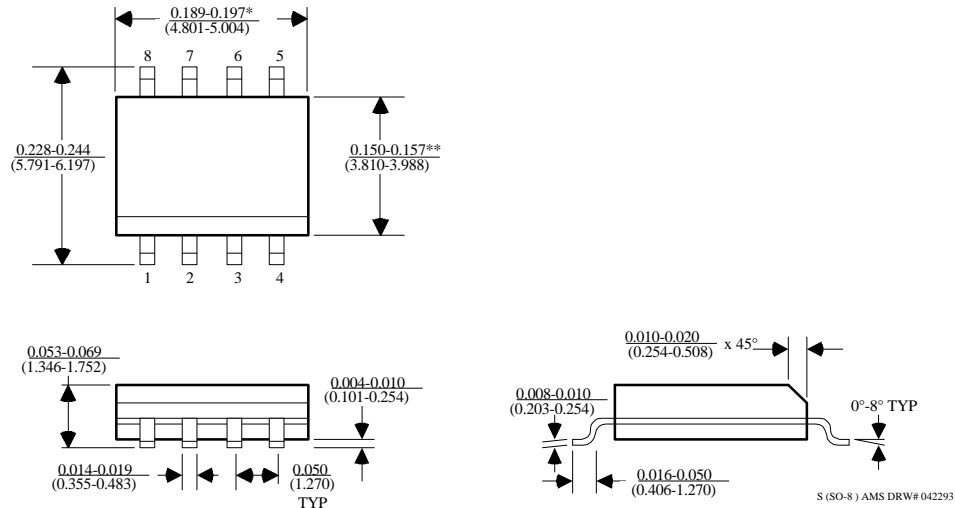

*DIMENSION DOES NOT INCLUDE MOLD FLASH. MOLD FLASH SHALL NOT EXCEED 0.006" (0.152mm) PER SIDE

**DIMENSION DOES NOT INCLUDE INTERLEAD FLASH. INTERLEAD FLASH SHALL NOT EXCEED 0.010" (0.254mm) PER SIDE

8 LEAD PLASTIC DIP PACKAGE (P)

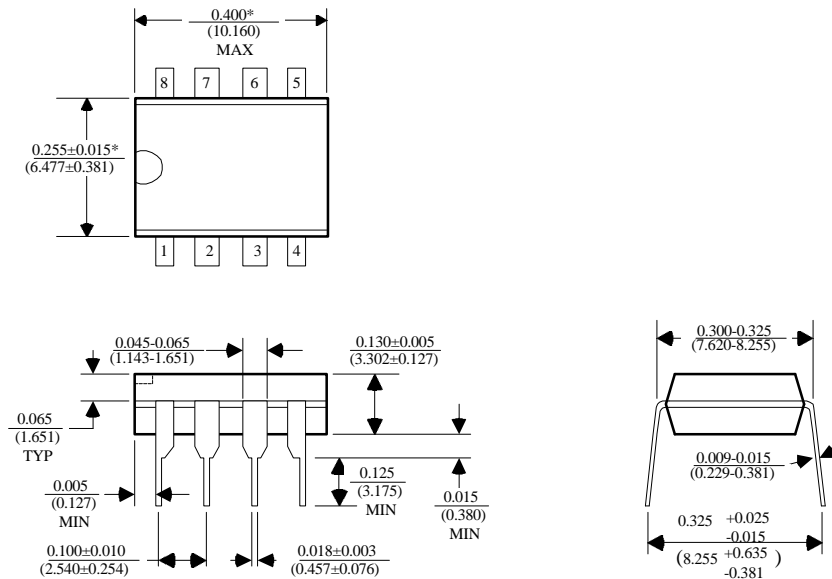

*DIMENSIONS DO NOT INCLUDE MOLD FLASH OR PROTUSIONS. MOLD FLASH OR PROTUSIONS SHALL NOT EXCEED 0.010" (0.254mm)