

# MOSEL

# MS62256

MOSEL-VITELIC

## 32K x 8 CMOS Static RAM

T 46-23-13

### FEATURES

- High-speed – 70/85/100/120 ns
- Low Power dissipation:
  - MS62256L
    - 385mW (Max.) Operating
    - 550µW (Typ.) Power Down
- Fully static operation
- All inputs and outputs directly TTL compatible
- Three state outputs
- Ultra low data retention supply current at  $V_{CC} = 2V$

### DESCRIPTION

The MOSEL MS62256 is a 262,144-bit static random access memory organized as 32,768 words by 8 bits and operates from a single 5 volt supply. It is built with MOSEL's high performance twin tub CMOS process. Inputs and three-state outputs are TTL compatible and allow for direct interfacing with common system bus structures. The MS62256 is available in a standard 28-pin 600 mil plastic DIP package and 330 mil SOP.

### PIN CONFIGURATIONS

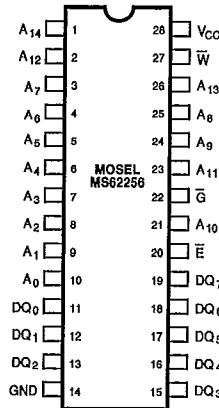

### FUNCTIONAL BLOCK DIAGRAM

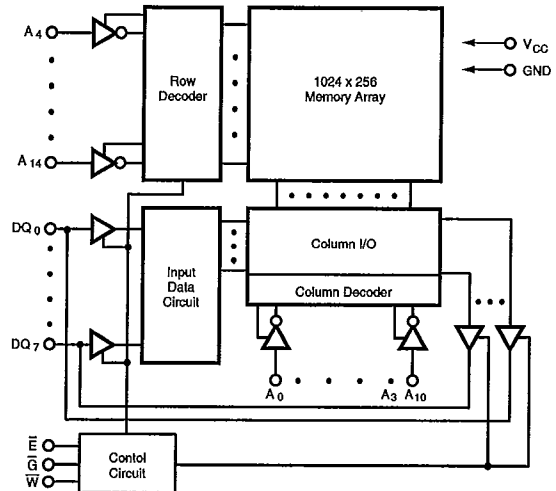

## MOSEL-VITELIC

MS62256

T-46-23-13

## PIN DESCRIPTIONS

**A<sub>0</sub> - A<sub>14</sub> Address Inputs**

These 15 address inputs select one of the 32768 8-bit words in the RAM.

 **$\bar{E}$  Chip Enable Input**

$\bar{E}$  is active LOW. The chip enable must be active to read from or write to the device. If it is not active, the device is deselected and is in a standby power mode. The DQ pins will be in the high-impedance state when deselected.

 **$\bar{G}$  Output Enable Input**

The output enable input is active LOW. If the output enable is active while the chip is selected and the write enable is inactive, data will be present on the DQ pins and they will be enabled. The DQ pins will be in the high impedance state when  $\bar{G}$  is inactive.

 **$\bar{W}$  Write Enable Input**

The write enable input is active LOW and controls read and write operations. With the chip enabled, when  $\bar{W}$  is HIGH and  $\bar{G}$  is LOW, output data will be present at the DQ pins; when  $\bar{W}$  is LOW, the data present on the DQ pins will be written into the selected memory location.

**DQ<sub>0</sub> - DQ<sub>7</sub> Data Input/Output Ports**

These 8 bidirectional ports are used to read data from or write data into the RAM.

**V<sub>CC</sub> Power Supply****GND Ground**

3

## TRUTH TABLE

| MODE    | $\bar{E}$ | $\bar{G}$ | $\bar{W}$ | I/O OPERATION    |
|---------|-----------|-----------|-----------|------------------|
| Standby | H         | X         | X         | High Z           |
| Read    | L         | L         | H         | D <sub>OUT</sub> |
| Read    | L         | H         | H         | High Z           |
| Write   | L         | X         | L         | D <sub>IN</sub>  |

ABSOLUTE MAXIMUM RATINGS <sup>(1)</sup>

| SYMBOL            | PARAMETER                    | RATING              | UNITS |
|-------------------|------------------------------|---------------------|-------|
| V <sub>CC</sub>   | Supply Voltage               | -0.3 to 7           | V     |
| V <sub>IN</sub>   | Input Voltage                | -0.3 to 7           |       |
| V <sub>DQ</sub>   | Input/Output Voltage Applied | -0.3 to 6           |       |
| T <sub>BIAS</sub> | Temperature Under Bias       | Plastic -10 to +125 | °C    |
| T <sub>STG</sub>  | Storage Temperature          | Plastic -40 to +150 | °C    |
| P <sub>D</sub>    | Power Dissipation            | 1.0                 | W     |
| I <sub>OUT</sub>  | DC Output Current            | 50                  | mA    |

1. Stresses greater than those listed under ABSOLUTE MAXIMUM RATINGS may cause permanent damage to the device. This is a stress rating only and functional operation of the device at these or any other conditions above those indicated in the operational sections of this specification is not implied. Exposure to absolute maximum rating conditions for extended periods may affect reliability.

## OPERATING RANGE

| RANGE      | AMBIENT TEMPERATURE | V <sub>CC</sub> |
|------------|---------------------|-----------------|
| Commercial | 0°C to +70°C        | 5V ± 10%        |

**MS62256**

MOSEL-VITELIC

T-46-23-13

**DC ELECTRICAL CHARACTERISTICS (over the commercial operating range)**

| PARAMETER NAME     | PARAMETER                                      | TEST CONDITIONS   | -70, -85 |                     |      | -10, -12 |                     |      | UNITS |
|--------------------|--|---|----------|---------------------|------|----------|---------------------|------|-------|
|                    |  |   | MIN.     | TYP. <sup>(1)</sup> | MAX. | MIN.     | TYP. <sup>(1)</sup> | MAX. |       |
| V <sub>IL</sub>    | Guaranteed Input Low Voltage <sup>(2)(3)</sup> |   | -0.3     | -                   | +0.8 | -0.3     | -                   | +0.8 | V     |
| V <sub>IH</sub>    | Guaranteed Input High Voltage <sup>(2)</sup>   |   | 2.2      | -                   | 6.0  | 2.2      | -                   | 6.0  | V     |
| I <sub>IL</sub>    | Input Leakage Current                          | V <sub>CC</sub> = Max, V <sub>IN</sub> = 0V to V <sub>CC</sub>  | -        | -                   | 2    | -        | -                   | 2    | μA    |
| I <sub>OL</sub>    | Output Leakage Current                         | V <sub>CC</sub> = Max, $\bar{E} = V_{IH}$ , or $\bar{G} = V_{IH}$ , V <sub>IN</sub> = 0V to V <sub>CC</sub> | -        | -                   | 2    | -        | -                   | 2    | μA    |
| V <sub>OL</sub>    | Output Low Voltage                             | V <sub>CC</sub> = Min, I <sub>OL</sub> = 4mA  | -        | -                   | 0.4  | -        | -                   | 0.4  | V     |
| V <sub>OH</sub>    | Output High Voltage                            | V <sub>CC</sub> = Min, I <sub>OH</sub> = -1mA   | 2.4      | 3.5                 | -    | 2.4      | 3.5                 | -    | V     |
| I <sub>CC</sub>    | Operating Power Supply Current                 | V <sub>CC</sub> = Max, $\bar{E} = V_{IL}$ , I <sub>I/O</sub> = 0mA, F <sub>max</sub> <sup>(4)</sup>         | -        | -                   | 85   | -        | -                   | 70   | mA    |
| I <sub>CCSB</sub>  | Standby Power Supply Current                   | V <sub>CC</sub> = Max, $\bar{E} = V_{IH}$ , I <sub>I/O</sub> = 0mA  | -        | -                   | 3    | -        | -                   | 3    | mA    |
| I <sub>CCSB1</sub> | Power Down Power Supply Current                | V <sub>CC</sub> = Max, $\bar{E} \geq V_{CC} - 0.2V$   | MS62256L |                     |      | -        | -                   | 0.1  | mA    |
|                    |  | V <sub>IN</sub> $\geq V_{CC} - 0.2V$ or V <sub>IN</sub> $\leq 0.2V$   | MS62256  |                     |      | -        | -                   | 1    | mA    |

1. Typical characteristics are at V<sub>CC</sub> = 5V, T<sub>A</sub> = 25°C.
2. These are absolute values with respect to device ground and all overshoots due to system or tester noise are included.
3. V<sub>IL</sub> (Min.) = -3.0V for pulse width ≤ 20ns
3. F<sub>max</sub> = 1/t<sub>RC</sub>.

**CAPACITANCE<sup>(1)</sup> (T<sub>A</sub> = 25°C, f = 1.0MHz)**

| SYMBOL          | PARAMETER                | CONDITIONS            | MAX. | UNIT |
|-----------------|--------------------------|-----------------------|------|------|
| C <sub>IN</sub> | Input Capacitance        | V <sub>IN</sub> = 0V  | 8    | pF   |
| C <sub>YO</sub> | Input/Output Capacitance | V <sub>I/O</sub> = 0V | 10   | pF   |

1. This parameter is guaranteed and not tested.

**DATA RETENTION CHARACTERISTICS<sup>(1)</sup> (over the commercial operating range)**

| SYMBOL            | PARAMETER                            | TEST CONDITIONS   | MIN.                           | TYP. <sup>(2)</sup> | MAX. <sup>(3)</sup> | UNITS |
|-------------------|--------------------------------------|---|--------------------------------|---------------------|---------------------|-------|
| V <sub>DR</sub>   | V <sub>CC</sub> for Data Retention   | $\bar{E} \geq V_{CC} - 0.2V$ , $\bar{G} \geq V_{CC} - 0.2V$ , V <sub>IN</sub> $\geq V_{CC} - 0.2V$ or V <sub>IN</sub> $\leq 0.2V$   | 2.0                            | -                   | -                   | V     |
| I <sub>CCDR</sub> | Data Retention Current               | $\bar{E}_1 \geq V_{CC} - 0.2V$ , $\bar{G} \geq V_{CC} - 0.2V$ , V <sub>IN</sub> $\geq V_{CC} - 0.2V$ or V <sub>IN</sub> $\leq 0.2V$ | -                              | 2                   | 50                  | μA    |
| t <sub>CDR</sub>  | Chip Deselect to Data Retention Time | See Retention Waveform  | 0                              | -                   | -                   | ns    |
| t <sub>R</sub>    | Operation Recovery Time              |   | t <sub>RC</sub> <sup>(4)</sup> | -                   | -                   | -     |

1. Applies to L version only
2. V<sub>CC</sub> = 2V, T<sub>A</sub> = +25°C
3. V<sub>CC</sub> = 3V
4. t<sub>RC</sub> = Read Cycle Time

**TIMING WAVEFORM LOW V<sub>CC</sub> DATA RETENTION WAVEFORM**

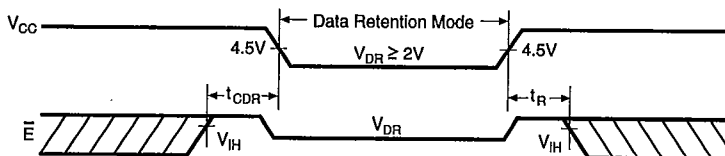

**AC TEST CONDITIONS**

|                           |            |
|---------------------------|------------|
| Input Pulse Levels        | 0V to 3.0V |
| Input Rise and Fall Times | 5ns        |
| Timing Reference Level    | 1.5V       |

**KEY TO SWITCHING WAVEFORMS**

| WAVEFORM | INPUTS                           | OUTPUTS                                   |
|----------|----------------------------------|---|
|          | MUST BE STEADY                   | WILL BE STEADY                            |
|          | MAY CHANGE FROM H TO L           | WILL BE CHANGING FROM H TO L              |
|          | MAY CHANGE FROM L TO H           | WILL BE CHANGING FROM L TO H              |
|          | DON'T CARE: ANY CHANGE PERMITTED | CHANGING: STATE UNKNOWN                   |
|          | DOES NOT APPLY                   | CENTER LINE IS HIGH IMPEDANCE "OFF" STATE |

3

**AC TEST LOADS AND WAVEFORMS**

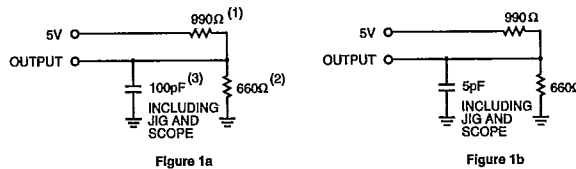

Equivalent to:

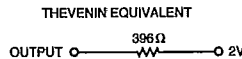

ALL INPUT PULSES

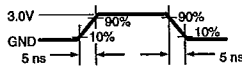

Figure 2

- 1. For 100 ns version, 1000Ω
- 2. For 100 ns version, 670Ω
- 3. For 100 ns version, 100pF

**AC ELECTRICAL CHARACTERISTICS (over the commercial operating range)**

**READ CYCLE**

| JEDEC PARAMETER NAME | PARAMETER NAME   | PARAMETER                          | MS62256L-70 |      | MS62256L-85 |      | MS62256L-10 |      | MS62256L-12 |      | UNIT |
|----------------------|------------------|------------------------------------|-------------|------|-------------|------|-------------|------|-------------|------|------|
|                      |                  |                                    | MIN.        | MAX. | MIN.        | MAX. | MIN.        | MAX. | MIN.        | MAX. |      |
| t <sub>AVAX</sub>    | t <sub>RC</sub>  | Read Cycle Time                    | 70          | -    | 85          | -    | 100         | -    | 120         | -    | ns   |
| t <sub>AVQV</sub>    | t <sub>AA</sub>  | Address Access Time                | -           | 70   | -           | 85   | -           | 100  | -           | 120  | ns   |
| t <sub>ELQV</sub>    | t <sub>ACS</sub> | Chip Enable Access Time            | -           | 70   | -           | 85   | -           | 100  | -           | 120  | ns   |
| t <sub>GLOX</sub>    | t <sub>OE</sub>  | Output Enable to Output Valid      | -           | 35   | -           | 40   | -           | 50   | -           | 60   | ns   |
| t <sub>EHQZ</sub>    | t <sub>CLZ</sub> | Chip Enable to Output Low Z        | 5           | -    | 5           | -    | 10          | -    | 5           | -    | ns   |
| t <sub>GLOX</sub>    | t <sub>OLZ</sub> | Output Enable to Output in Low Z   | 5           | -    | 5           | -    | 10          | -    | 5           | -    | ns   |
| t <sub>EHQZ</sub>    | t <sub>CHZ</sub> | Chip Disable to Output in High Z   | 0           | 30   | 0           | 35   | 0           | 35   | 0           | 40   | ns   |
| t <sub>GHAZ</sub>    | t <sub>OHZ</sub> | Output Disable to Output in High Z | 0           | 30   | 0           | 35   | 0           | 35   | 0           | 40   | ns   |
| t <sub>AXQX</sub>    | t <sub>OH</sub>  | Output Hold from Address Change    | 10          | -    | 10          | -    | 10          | -    | 10          | -    | ns   |

**MS62256**

MOSEL-VITELIC

T-46-23-13

**SWITCHING WAVEFORMS (READ CYCLE)**

**READ CYCLE 1<sup>(1)</sup>**

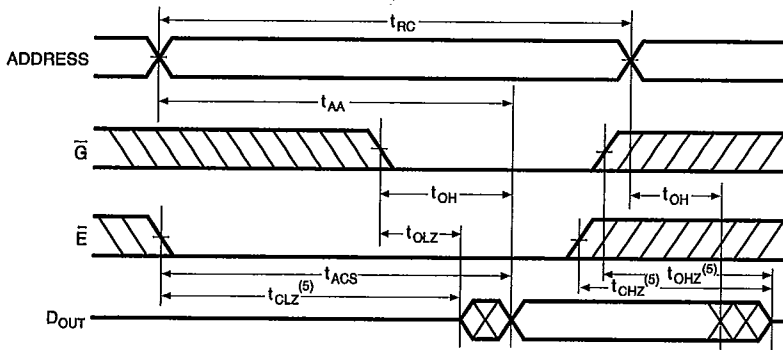

**READ CYCLE 2<sup>(1, 2, 4)</sup>**

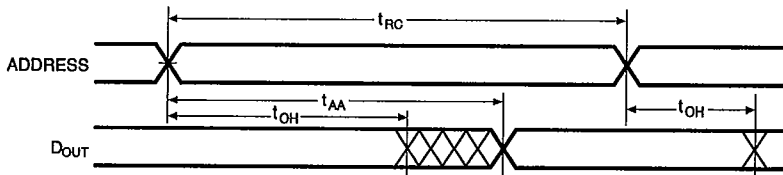

**READ CYCLE 3<sup>(1, 3, 4)</sup>**

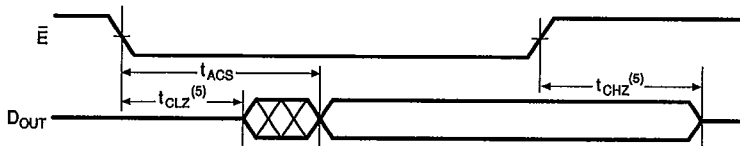

**NOTES:**

1.  $\bar{W}$  is High for READ Cycle.
2. Device is continuously selected  $\bar{E} = V_{IL}$ .
3. Address valid prior to or coincident with  $\bar{E}$  transition low.
4.  $\bar{G} = V_{IL}$ .
5. Transition is measured  $\pm 500mV$  from steady state with  $C_L = 5pF$  as shown in Figure 1b on page 4. This parameter is guaranteed and not 100% tested.

AC ELECTRICAL CHARACTERISTICS (over the commercial operating range)

T-46-23-13

WRITE CYCLE

| JEDEC<br>PARAMETER<br>NAME | PARAMETER<br>NAME | PARAMETER                          | MS62256L-70 |      | MS62256L-85 |      | MS62256L-10 |      | MS62256L-12 |      | UNIT |
|----------------------------|-------------------|------------------------------------|-------------|------|-------------|------|-------------|------|-------------|------|------|
|                            |                   |                                    | MIN.        | MAX. | MIN.        | MAX. | MIN.        | MAX. | MIN.        | MAX. |      |
| t <sub>AVAX</sub>          | t <sub>WC</sub>   | Write Cycle Time                   | 70          | -    | 85          | -    | 100         | -    | 120         | -    | ns   |
| t <sub>ELWH</sub>          | t <sub>CW</sub>   | Chip Enable to End of Write        | 45          | -    | 60          | -    | 70          | -    | 85          | -    | ns   |
| t <sub>AVWL</sub>          | t <sub>AS</sub>   | Address Set up Time                | 0           | -    | 0           | -    | 0           | -    | 0           | -    | ns   |
| t <sub>AVWH</sub>          | t <sub>AW</sub>   | Address Valid to End of Write      | 65          | -    | 65          | -    | 70          | -    | 85          | -    | ns   |
| t <sub>WLWH</sub>          | t <sub>WP</sub>   | Write Pulse Width                  | 40          | -    | 40          | -    | 50          | -    | 70          | -    | ns   |
| t <sub>WHAX</sub>          | t <sub>WR</sub>   | Write Recovery Time                | 5           | -    | 5           | -    | 0           | -    | 0           | -    | ns   |
| t <sub>WLOZ</sub>          | t <sub>WHZ</sub>  | Write to Output in High Z          | 0           | 25   | 0           | 30   | 0           | 35   | 0           | 40   | ns   |
| t <sub>DVWH</sub>          | t <sub>DW</sub>   | Data Valid to End of Write         | 30          | -    | 30          | -    | 30          | -    | 50          | -    | ns   |
| t <sub>WHDX</sub>          | t <sub>DH</sub>   | Data Hold from Write Time          | 5           | -    | 5           | -    | 0           | -    | 0           | -    | ns   |
| t <sub>GHZQ</sub>          | t <sub>OHZ</sub>  | Output Disable to Output in High Z | 0           | 25   | 0           | 30   | 0           | 35   | 0           | 40   | ns   |
| t <sub>WHOX</sub>          | t <sub>OW</sub>   | Output Active from End of Write    | 5           | -    | 5           | -    | 5           | -    | 5           | -    | ns   |

3

SWITCHING WAVEFORMS (WRITE CYCLE)

WRITE CYCLE 1<sup>(1)</sup>

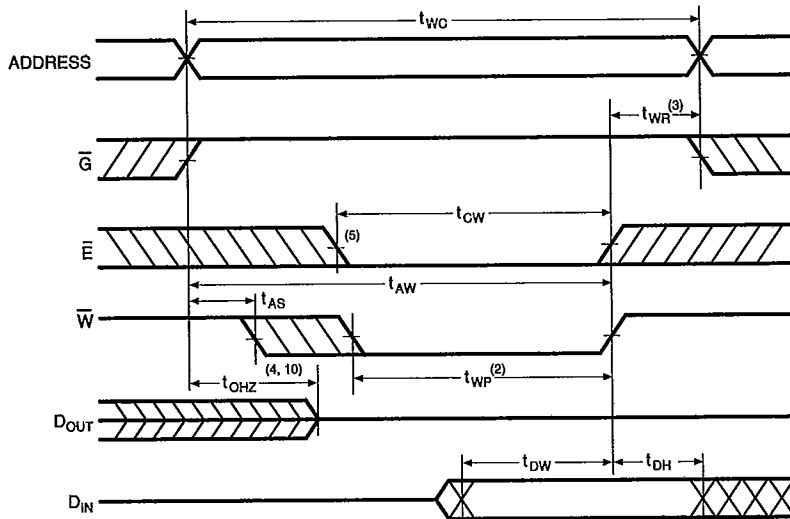

## MS62256

MOSEL-VITELIC

## SWITCHING WAVEFORMS (WRITE CYCLE)

T-46-23-13

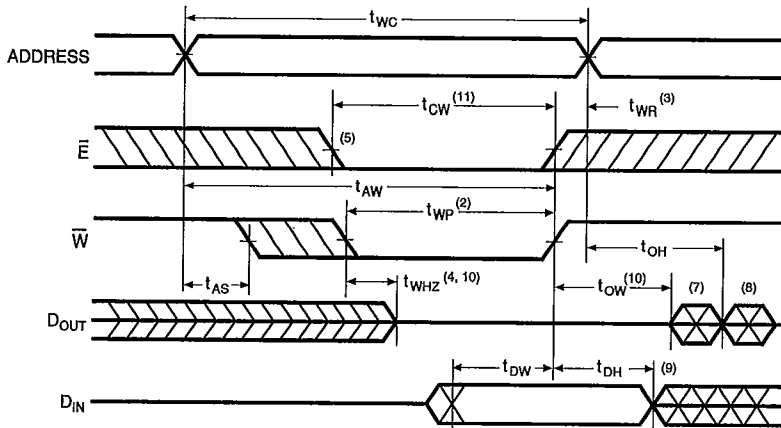
WRITE CYCLE 2<sup>(1,6)</sup>

## NOTES:

- $\bar{W}$  must be high during address transitions.
- The internal write time of the memory is defined by the overlap  $\bar{E}$  active and  $\bar{W}$  low. Both signals must be active to initiate and any one signal can terminate a write by going inactive. The data input setup and hold timing should be referenced to the second transition edge of the signal that terminates the write.
- $T_{WR}$  is measured from the earlier of  $\bar{E}$  or  $\bar{W}$  going high at the end of write cycle.
- During this period, DQ pins are in the output state so that the input signals of opposite phase to the outputs must not be applied.
- If the  $\bar{E}$  low transition occurs simultaneously with the  $\bar{W}$  low transitions or after the  $\bar{W}$  low transition, outputs remain in a high impedance state.
- $\bar{G}$  is continuously low ( $\bar{G} = V_{IL}$ ).
- $D_{OUT}$  is the same phase of write data of this write cycle.
- $D_{OUT}$  is the read data of next address.
- If  $\bar{E}$  is low during this period, DQ pins are in the output state. Then the data input signals of opposite phase to the outputs must not be applied to them.
- Transition is measured  $\pm 50mV$  from steady state with  $C_L = 5pF$  as shown in Figure 1b. This parameter is guaranteed and not 100% tested.
- $t_{CW}$  is measured from  $\bar{E}$  going low to the end of write.

## ORDERING INFORMATION

| SPEED<br>(ns) | ORDERING<br>PART NUMBER | PACKAGE REFERENCE NO. | TEMPERATURE<br>RANGE |
|---------------|-------------------------|-----------------------|----------------------|
| 70            | MS62256L-70FC           | S28-3                 | 0°C to +70°C         |
| 70            | MS62256L-70PC           | P28-1                 | 0°C to +70°C         |
| 85            | MS62256L-85FC           | S28-3                 | 0°C to +70°C         |
| 85            | MS62256L-85PC           | P28-1                 | 0°C to +70°C         |
| 100           | MS62256L-10FC           | S28-2                 | 0°C to +70°C         |
| 100           | MS62256L-10PC           | P28-1                 | 0°C to +70°C         |
| 120           | MS62256L-12FC           | S28-2                 | 0°C to +70°C         |
| 120           | MS62256L-12PC           | P28-1                 | 0°C to +70°C         |