

**GENERAL DESCRIPTION**

The B3-12 is specifically designed for VHF land mobile operation providing 3 watts of RF power output from a 12 volt supply and operating over the frequency band of 150-175 MHz.

**B3-12**  
**3 WATTS - 12 VOLTS**  
**150-175 MHz**

**LAND MOBILE**

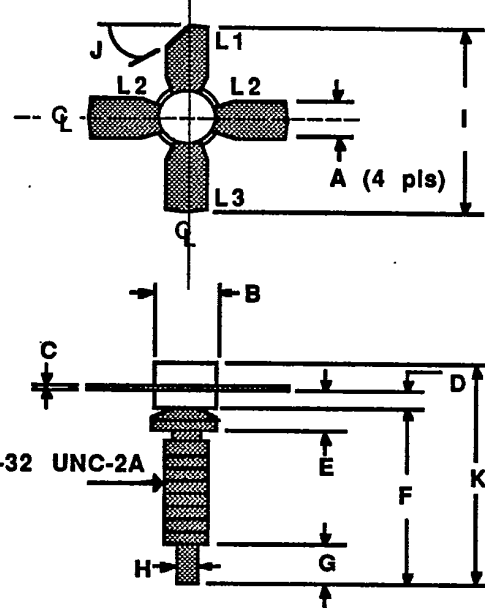

**ABSOLUTE MAXIMUM RATINGS**

Maximum Power Dissipation @ 25°C Case Temperature 10 W

**Maximum Voltage and Current**

BVces Collector to Emitter Voltage 36 V  
 BVebo Emitter to Base Voltage 4.0 V  
 Ic Collector Current 1.0 A

**Maximum Temperatures**

Storage Temperature -65 to +150°C  
 Operating Junction Temperature +200°C

**POWER OUTPUT VS POWER INPUT (TYPICAL)**

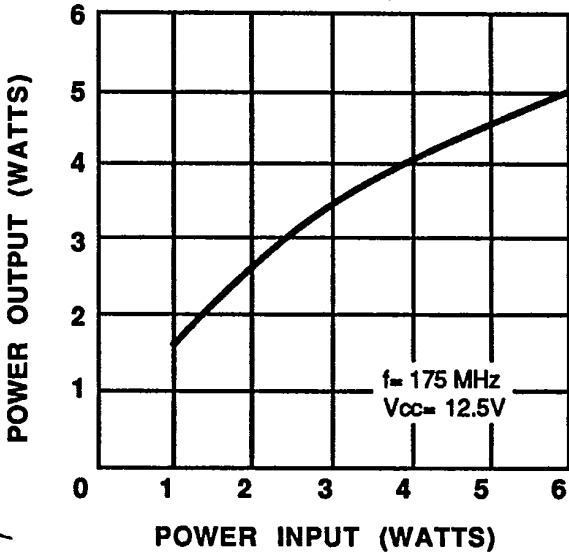

DIM	Millimeter	TOL	Inches	TOL	
L1 : C					
L2 : E	A	5.71	.13	.225	.005
L3 : B	B	9.52 DIA	.13	.375 DIA	.005
	C	0.13	.02	.005	.001
	D	1.78	.13	.070	.005
	E	4.06	.13	.160	.005
	F	14.59	.25	.585	.010
	G	3.30	.13	.130	.005
	H	1.52	.13	.060	.005
	I	25.40	.25	1.000	.010
	J	45°	5°	45°	5°
	K	19.00	REF	.748	REF

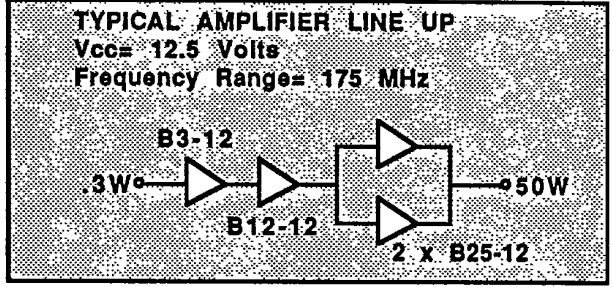

**B3-12-2**

**ELECTRICAL CHARACTERISTICS<sup>1</sup>**

SYMBOL	CHARACTERISTICS	TEST CONDITIONS	MIN.	TYP.	MAX.	UNITS
P <sub>out</sub>	Power Output	f = 175 MHz V <sub>cc</sub> = 12.5V	3.0			Watts
P <sub>in</sub>	Power Input				0.3	Watts
P <sub>g</sub>	Power Gain			11		dB
η <sub>c</sub>	Collector Efficiency			60		%
V <sub>SWR</sub>	Load Mismatch Tolerance					∞:1
B <sub>Vebo</sub>	Breakdown Voltage (Emitter to Base)	I <sub>c</sub> = 0A, I <sub>e</sub> = 5mA	4.0			Volts
B <sub>Vces</sub>	Breakdown Voltage (Collector to Emitter)	V <sub>be</sub> = 0A, I <sub>c</sub> = 5mA	36			Volts
B <sub>Vceo</sub>	Breakdown Voltage (Collector to Emitter)	I <sub>b</sub> = 0A, I <sub>c</sub> = 50mA	18			Volts
C <sub>ob</sub>	Capacitance-Collector to Base	V <sub>cb</sub> = 12V, I <sub>e</sub> = 0			15	pF
h <sub>FE</sub>	DC-Current Gain		10			
θ <sub>jc</sub>	Thermal Resistance				17.5	°C/W

Note 1: T<sub>c</sub> = +25°C unless otherwise specified

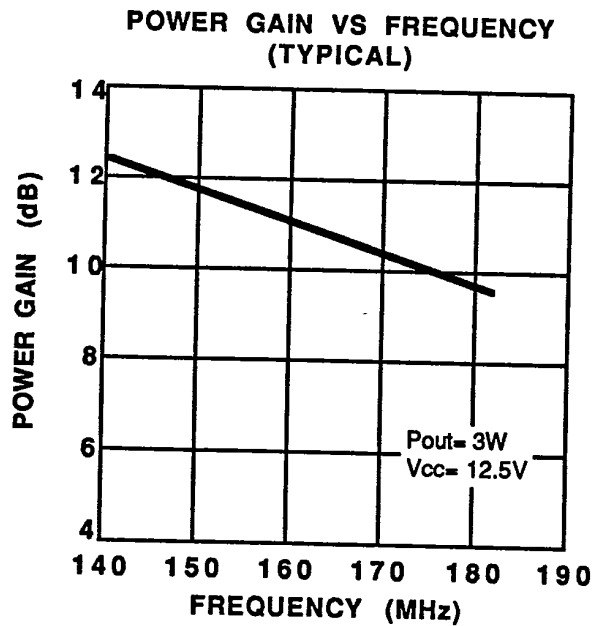

SPECIFICATIONS MAY BE SUBJECT TO CHANGE WITHOUT NOTICE

265

B3-12-3

SERIES INPUT RESISTANCE VS FREQUENCY (TYPICAL)

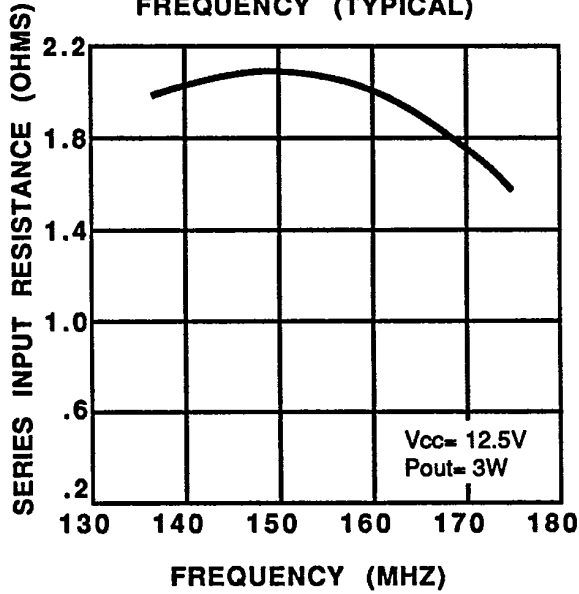

SERIES INPUT REACTANCE VS FREQUENCY (TYPICAL)

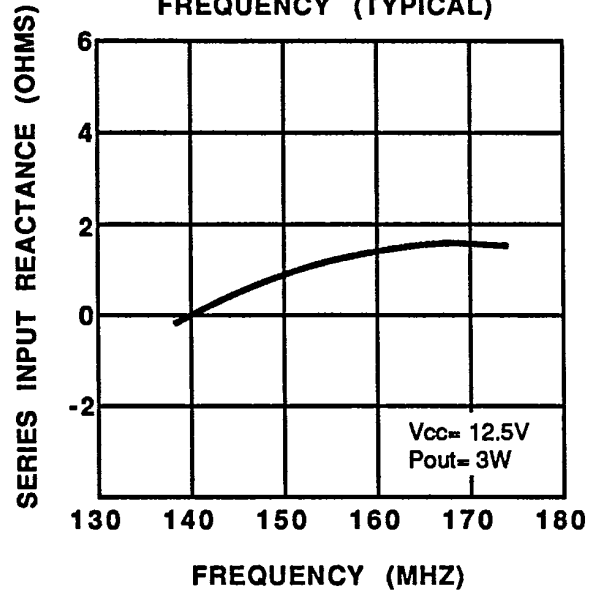

SERIES LOAD IMPEDANCE VS FREQUENCY (TYPICAL)

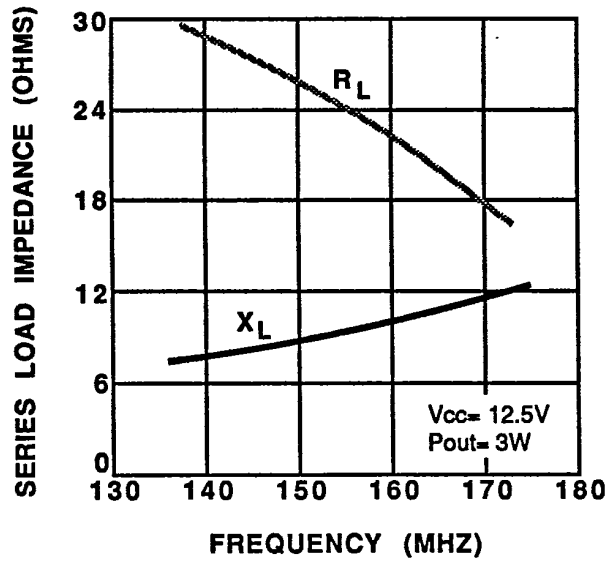

269

B3-12-4

### B3-12 TEST AMPLIFIER 175 MHz

