



N-Channel Depletion-Mode Vertical DMOS FETs

Features

- ▶ High input impedance
- ▶ Low input capacitance
- ▶ Fast switching speeds
- ▶ Low on resistance
- ▶ Free from secondary breakdown
- ▶ Low input and output leakage

Applications

- ▶ Normally-on switches
- ▶ Solid state relays
- ▶ Converters
- ▶ Linear amplifiers
- ▶ Constant current sources
- ▶ Power supply circuits
- ▶ Telecom

General Description

The Supertex DN2535 and DN2540 are low threshold depletion-mode (normally-on) transistors utilizing an advanced vertical DMOS structure and Supertex's well-proven silicon-gate manufacturing process. This combination produces devices with the power handling capabilities of bipolar transistors and with the high input impedance and positive temperature coefficient inherent in MOS devices. Characteristic of all MOS structures, these devices are free from thermal runaway and thermally-induced secondary breakdown.

Supertex's vertical DMOS FETs are ideally suited to a wide range of switching and amplifying applications where high breakdown voltage, high input impedance, low input capacitance, and fast switching speeds are desired.

Product marking for TO-243AA:

DN5D*

where * = 2-week alpha date code

Ordering Information

BV _{DSX} / BV _{DGX}	R _{DS(ON)} (max)	I _{DSS} (min)	Package Options		
			TO-92	TO-220	TO-243AA ¹
350V	25Ω	150mA	DN2535N3	DN2535N5	DN2535N8
			DN2535N3-G	DN2535N5-G	DN2535N8-G
400V	25Ω	150mA	DN2540N3	DN2540N5	DN2540N8
			DN2540N3-G	DN2540N5-G	DN2540N8-G

-G indicates package is RoHS compliant ('Green')
¹Same as SOT-89.



Absolute Maximum Ratings

Parameter	Value
Drain-to-source voltage	BV _{DSX}
Drain-to-gate voltage	BV _{DGX}
Gate-to-source voltage	±20V
Operating and storage temperature	-55°C to +150°C
Soldering temperature*	300°C

Absolute Maximum Ratings are those values beyond which damage to the device may occur. Functional operation under these conditions is not implied. Continuous operation of the device at the absolute rating level may affect device reliability. All voltages are referenced to device ground.

*Distance of 1.6mm from case for 10 seconds.

Pin Configurations

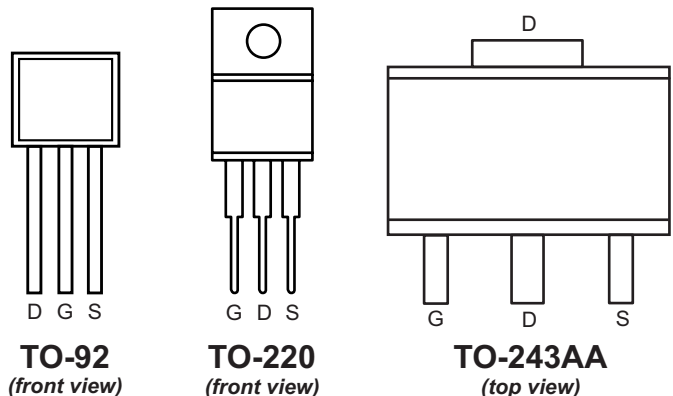

Thermal Characteristics

Package	I_D (continuous) ¹	I_D (pulsed)	Power Dissipation @ $T_C = 25^\circ\text{C}$	θ_{jc} ($^\circ\text{C}/\text{W}$)	θ_{jc} ($^\circ\text{C}/\text{W}$)	I_{DR}^1	I_{DRM}
TO-92	120mA	500mA	1.0W	125	170	120mA	500mA
TO-220	500mA	500mA	15W	8.3	70	500mA	500mA
TO-243AA	170mA	500mA	1.6W ²	15	78 ²	170mA	500mA

Notes:

- I_D (continuous) is limited by max rated T_j .
- Mounted on FR4 board, 25mm x 25mm x 1.57mm. $T_A = 25^\circ\text{C}$.

Electrical Characteristics

Symbol	Parameter	Min	Typ	Max	Units	Conditions
BV_{DSX}	Drain-to-source breakdown voltage	DN2535	350	-	-	V $V_{GS} = -5.0\text{V}, I_D = 100\mu\text{A}$
		DN2540	400	-	-	
$V_{GS(OFF)}$	Gate-to-source OFF voltage	-1.5	-	-3.5	V	$V_{DS} = 25\text{V}, I_D = 10\mu\text{A}$
$\Delta V_{GS(OFF)}$	Change in $V_{GS(OFF)}$ with temperature	-	-	4.5	mV/ $^\circ\text{C}$	$V_{DS} = 25\text{V}, I_D = 10\mu\text{A}$
I_{GSS}	Gate body leakage current	-	-	100	nA	$V_{GS} = \pm 20\text{V}, V_{DS} = 0\text{V}$
$I_{D(OFF)}$	Drain-to-source leakage current	-	-	10	μA	$V_{DS} = \text{Max rating}, V_{GS} = -10\text{V}$
		-	-	1.0	mA	$V_{DS} = 0.8 \text{ Max Rating}, V_{GS} = -10\text{V}, T_A = 125^\circ\text{C}$
I_{DSS}	Saturated drain-to-source current	150	-	-	mA	$V_{GS} = 0\text{V}, V_{DS} = 25\text{V}$
$R_{DS(ON)}$	Static drain-to-source ON-state resistance	-	17	25	Ω	$V_{GS} = 0\text{V}, I_D = 120\text{mA}$
$\Delta R_{DS(ON)}$	Change in $R_{DS(ON)}$ with temperature	-	-	1.1	%/ $^\circ\text{C}$	$V_{GS} = 0\text{V}, I_D = 120\text{mA}$
G_{FS}	Forward transconductance	-	325	-	mmho	$V_{DS} = 10\text{V}, I_D = 100\text{mA}$
C_{ISS}	Input capacitance	-	200	300	pF	$V_{GS} = -10\text{V}, V_{DS} = 25\text{V}, f = 1\text{MHz}$
C_{OSS}	Common source output capacitance	-	12	30		
C_{RSS}	Reverse transfer capacitance	-	1	5		
$t_{d(ON)}$	Turn-ON delay time	-	-	10	ns	$V_{DD} = 25\text{V}, I_D = 150\text{mA}, R_{GEN} = 25\Omega,$
t_r	Rise time	-	-	15		
$t_{d(OFF)}$	Turn-OFF delay time	-	-	15		
t_f	Fall time	-	-	20		
V_{SD}	Diode forward voltage drop	-	-	1.8	V	$V_{GS} = -10\text{V}, I_{SD} = 120\text{mA}$
t_{rr}	Reverse recovery time	-	800	-	ns	$V_{GS} = -10\text{V}, I_{SD} = 1.0\text{A}$

Notes:

- All D.C. parameters 100% tested at 25°C unless otherwise stated. (Pulse test: 300 μs pulse, 2% duty cycle.)
- All A.C. parameters sample tested.

Switching Waveforms and Test Circuit

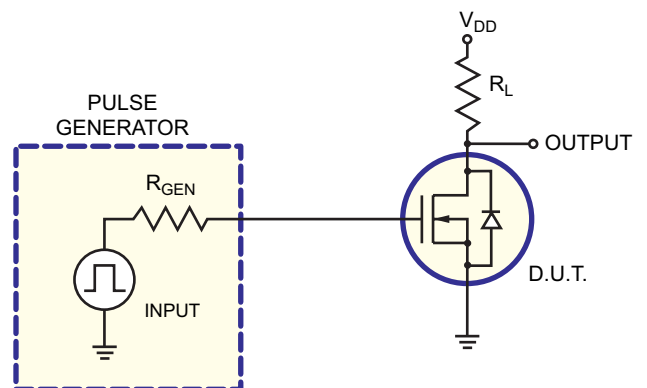
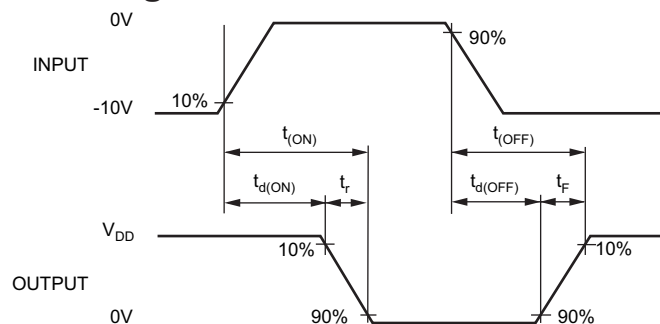

Typical Performance Curves

Output Characteristics

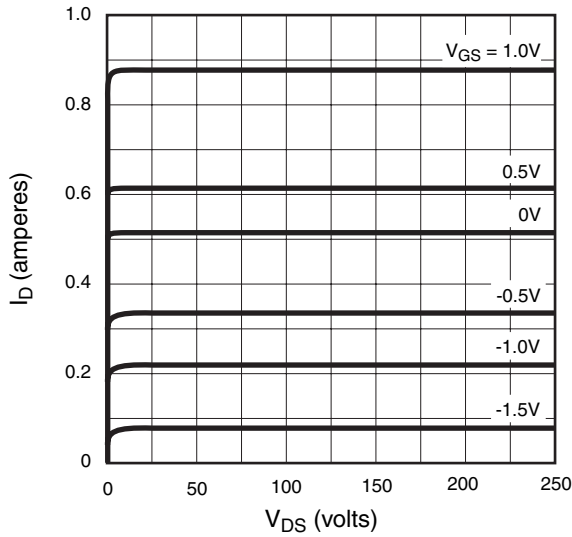

Saturation Characteristics

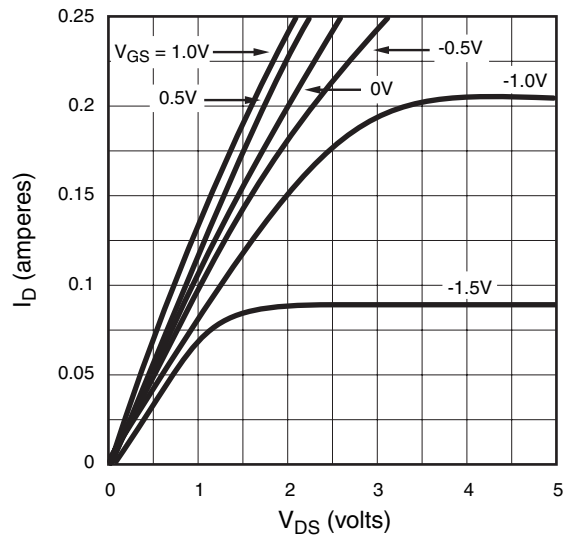

Transconductance vs. Drain Current

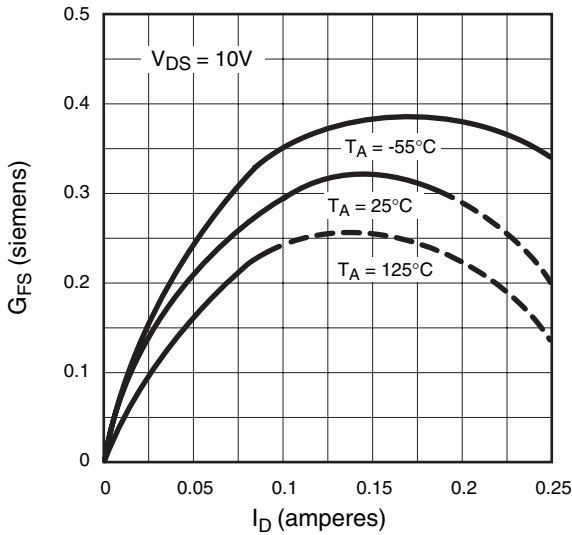

Power Dissipation vs. Case Temperature

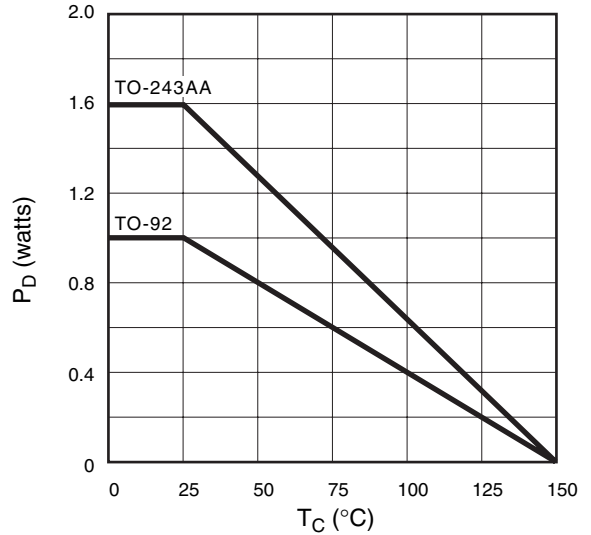

Maximum Rated Safe Operating Area

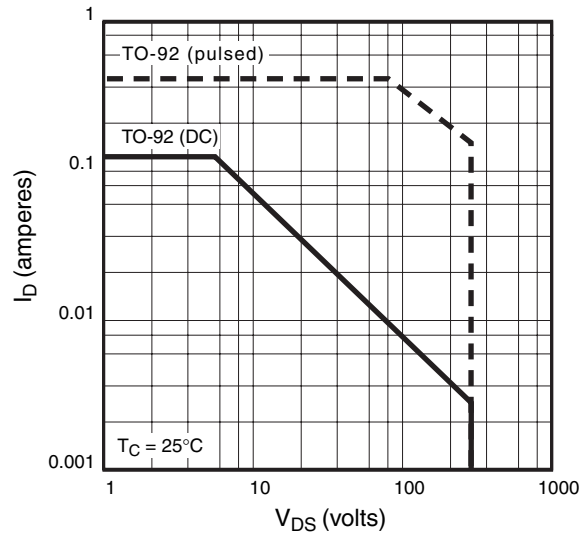

Thermal Response Characteristics

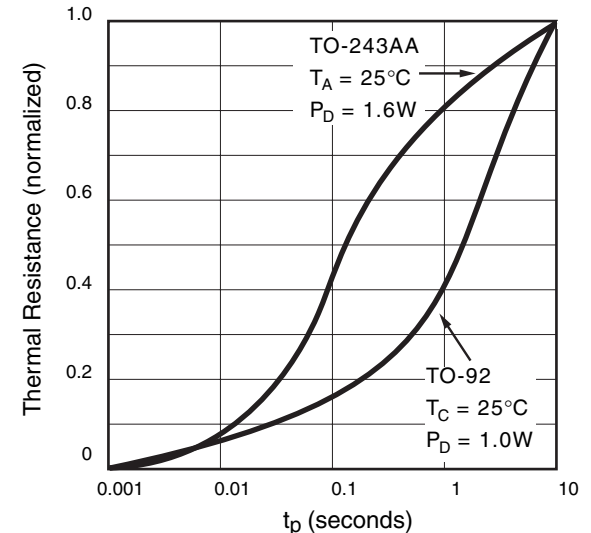

Typical Performance Curves (cont.)

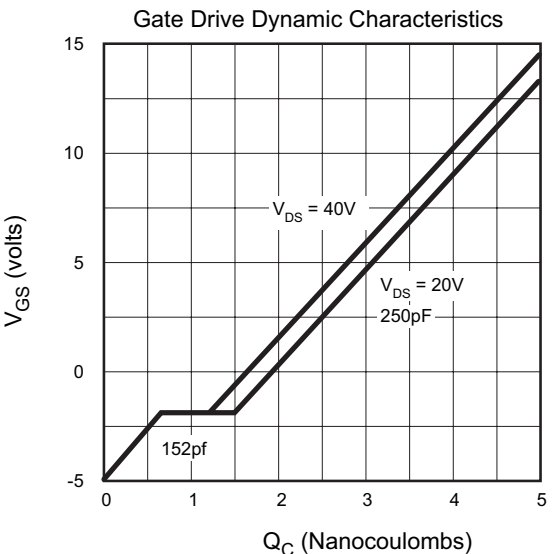
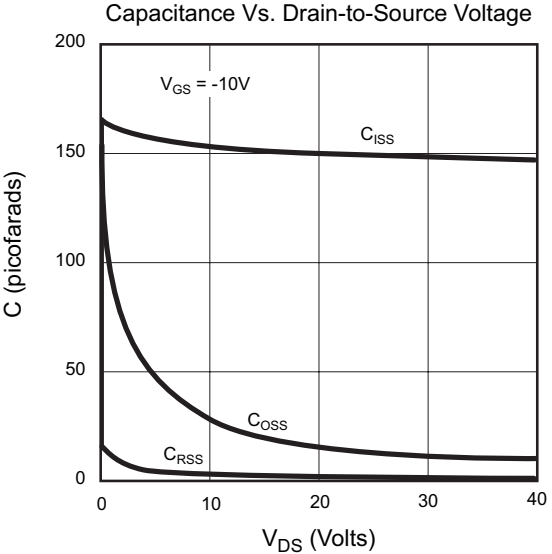
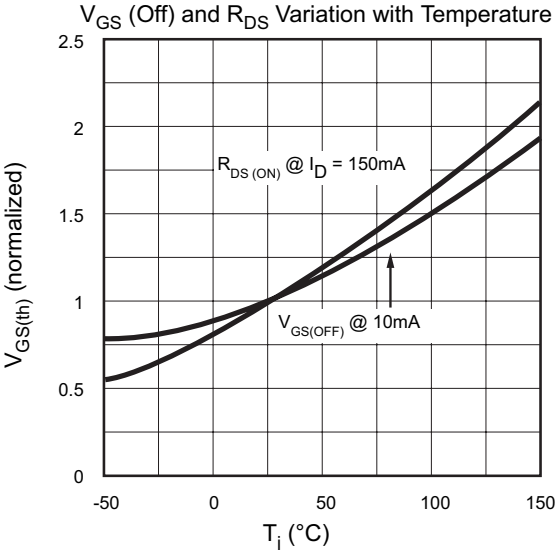
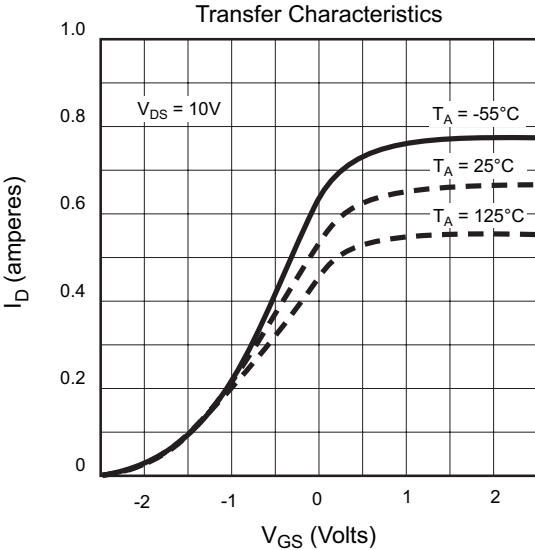
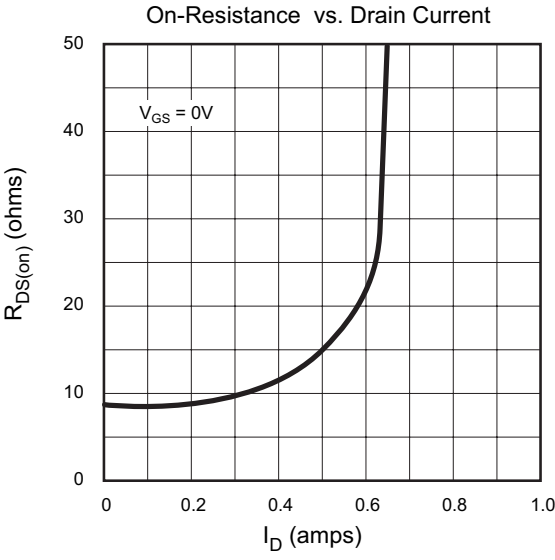
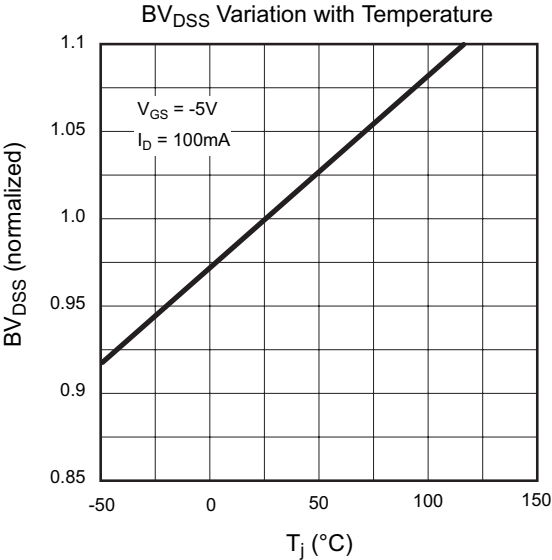

3-Lead TO-92 Package Outline (N3)

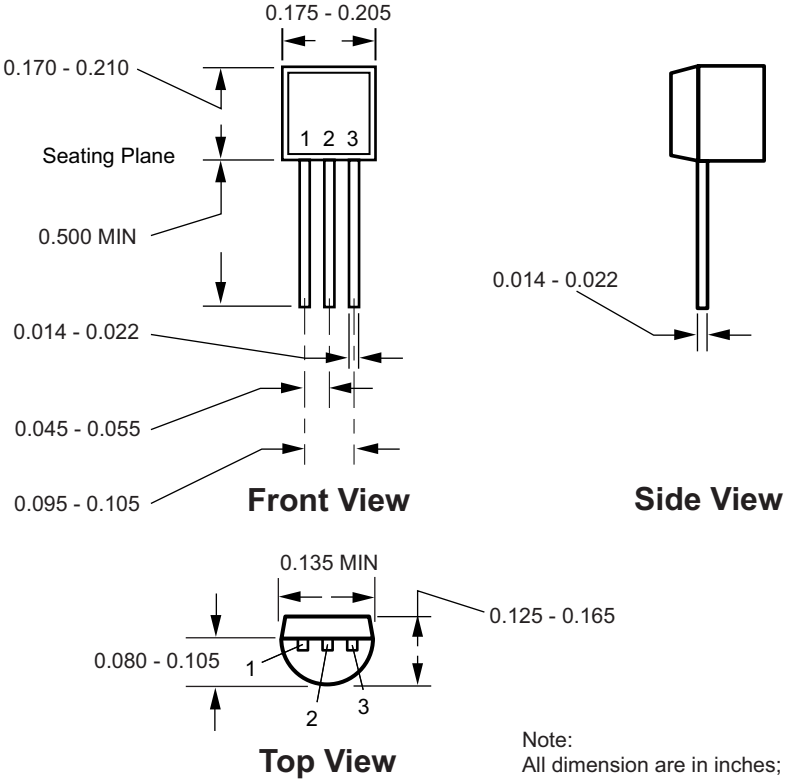

3-Lead TO-220 Package Outline (N5)

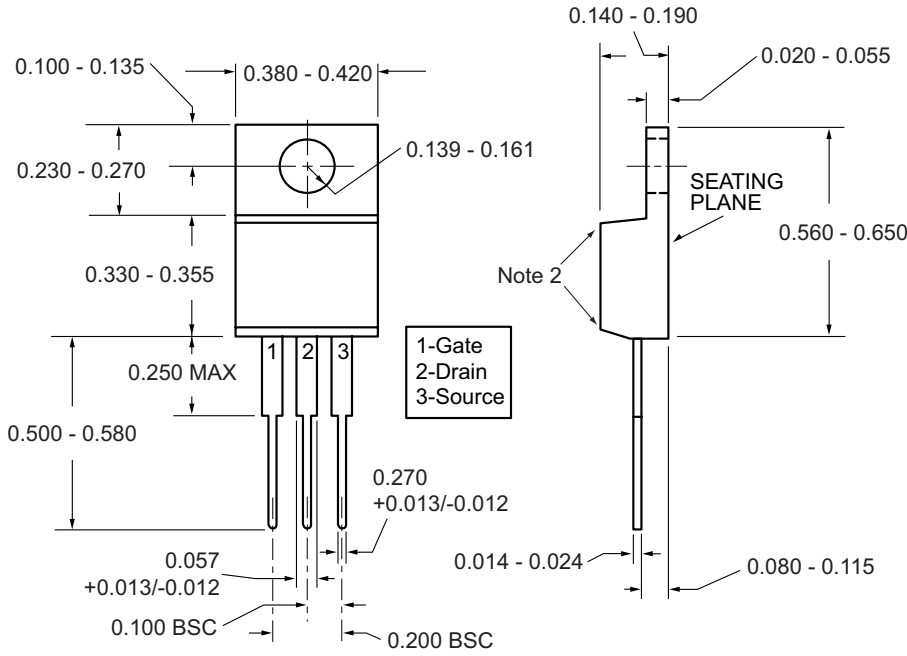

- Notes:
1. All dimensions in inches; angles in degrees
 2. Corner shape may differ from drawing
 3. Lead 2 electrically connected to mounting tab

3-Lead TO-243AA (SOT-89) Surface Mount Package (N8)

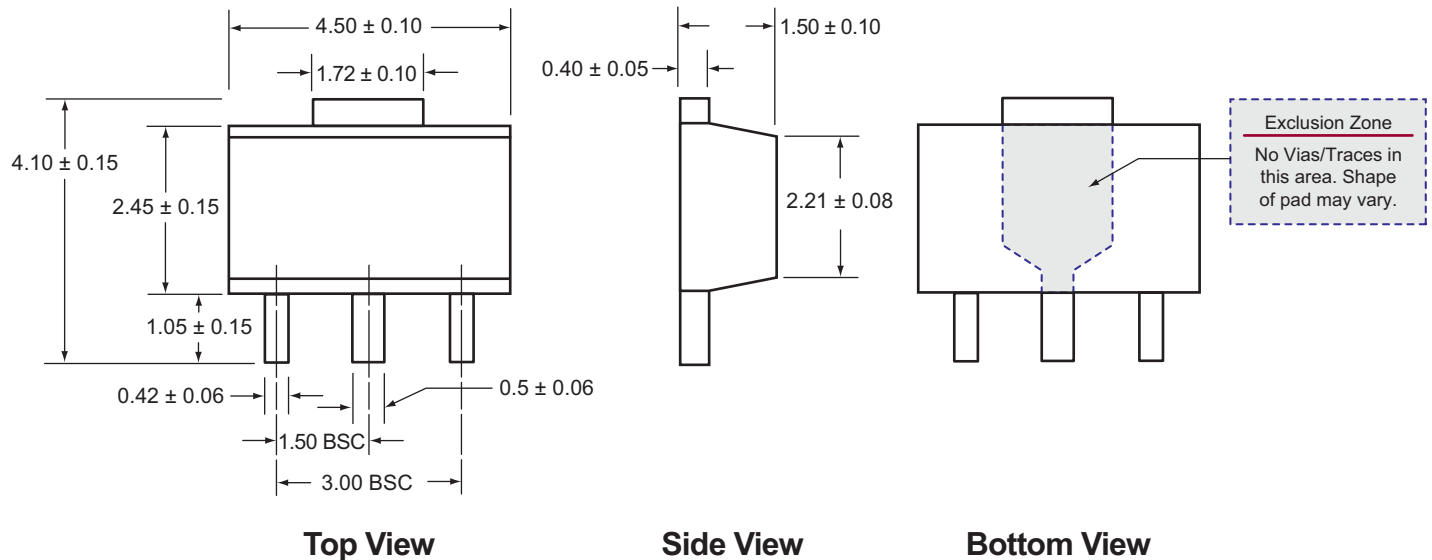

Notes:

1. All dimensions are in millimeters; all angles in degrees.

(The package drawing(s) in this data sheet may not reflect the most current specifications. For the latest package outline information go to <http://www.supertex.com/packaging.html>.)

Supertex inc. does not recommend the use of its products in life support applications, and will not knowingly sell its products for use in such applications, unless it receives an adequate "product liability indemnification insurance agreement". **Supertex** does not assume responsibility for use of devices described and limits its liability to the replacement of the devices determined defective due to workmanship. No responsibility is assumed for possible omissions or inaccuracies. Circuitry and specifications are subject to change without notice. For the latest product specifications, refer to the **Supertex** website: <http://www.supertex.com>.