

F611 & F612 Series Metallized Polyester Film, 5 – 37.5 mm Lead Spacing, 50 – 1,000 VDC

Overview

The F611 and F612 Series is constructed of metallized wound or stacked polyester film capacitor with radial leads of tinned wire. Radial leads are electrically welded to the contact metal layer on the ends of the capacitor winding. The capacitor is encapsulated in a self-extinguishing material meeting the requirements of UL 94 V-0.

Applications

Typical applications include blocking, coupling, decoupling, bypassing and interference suppression in low voltage applications such as automotive. Not for use with the mains.

Benefits

- Voltage range: 50 – 1,000 VDC
- Capacitance range: 0.001 – 330 μ F
- Lead spacing: 5 – 37.5 mm
- Capacitance tolerance: \pm 10%, \pm 20%, \pm 5% on request
- Climatic category: 55/105/56, IEC 60068-1
- Tape and reel packaging in accordance with IEC 60286-2
- RoHS Compliant and lead-free terminations
- Operating temperature range of -55°C to +105°C

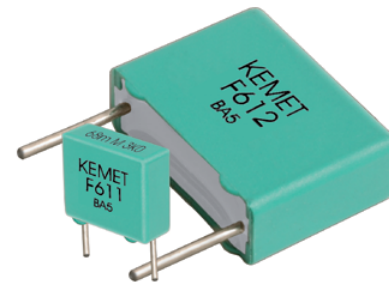

Part Number System

F	611	J	F	104	M	050	C
Capacitor Class	Series	Lead Spacing (mm)	Size Code	Capacitance Code (pF)	Capacitance Tolerance	Voltage (VDC)	Lead and Packaging Code
F = Film	Metallized Polyester 611 = Wound 612 = Stacked	J = 5 K = 7.5 A = 10.0 B = 15.0 D = 22.5 F = 27.5 R = 37.5	See Dimension Table	First two digits represent significant figures. Third digit specifies number of zeros.	J = \pm 5% K = \pm 10% M = \pm 20%	050 = 50 063 = 63 100 = 100 160 = 160 250 = 250 400 = 400 630 = 630 1K0 = 1000	See Ordering Options Table

Ordering Options Table

Lead Spacing Nominal (mm)	Type of Leads and Packaging	Lead Length (mm)	Lead and Packaging Code
5	Standard Lead and Packaging Options		
	Bulk (Bag) – Short Leads	4 +2/-0	C
	Bulk (Bag) – Long Leads	17 +0/-1	A
	Tape & Reel (Standard Reel)	$H_0 = 18.5 \pm 0.5$	L
	Other Lead and Packaging Options		
	Bulk (Bag) – Max Length Leads	20 +5/-0	ALLOL
	Ammo Pack	$H_0 = 18.5 \pm 0.5$	R
7.5	Standard Lead and Packaging Options		
	Bulk (Bag) – Short Leads	4 +2/-0	C
	Bulk (Bag) – Long Leads	17 +0/-1	A
	Tape & Reel (Standard Reel)	$H_0 = 18.5 \pm 0.5$	L
	Other Lead and Packaging Options		
	Bulk (Bag) – Max Length Leads	20 +5/-0	ALLOL
	Ammo Pack	$H_0 = 18.5 \pm 0.5$	R
10	Standard Lead and Packaging Options		
	Bulk (Bag) – Short Leads	4 +2/-0	C
	Bulk (Bag) – Long Leads	17 +0/-1	A
	Tape & Reel (Standard Reel)	$H_0 = 18.5 \pm 0.5$	L
	Other Lead and Packaging Options		
	Bulk (Bag) – Max Length Leads	20 +5/-0	ALLOL
	Ammo Pack	$H_0 = 18.5 \pm 0.5$	R
Tape & Reel (Large Reel)	$H_0 = 18.5 \pm 0.5$	P	
15	Standard Lead and Packaging Options		
	Bulk (Bag) – Short Leads	4 +2/-0	C
	Bulk (Bag) – Long Leads	17 +0/-1	A
	Tape & Reel (Standard Reel)	$H_0 = 18.5 \pm 0.5$	L
	Pizza Pack	4 +2/-0	Z
	Other Lead and Packaging Options		
	Bulk (Bag) – Max Length Leads	25 +5/-0	ALROL
	Ammo Pack	$H_0 = 18.5 \pm 0.5$	R
Tape & Reel (Large Reel)	$H_0 = 18.5 \pm 0.5$	P	

Ordering Options Table cont'd

Lead Spacing Nominal (mm)	Type of Leads and Packaging	Lead Length (mm)	Lead and Packaging Code
22.5	Standard Lead and Packaging Options		
	Bulk (Tray) – Short Leads	4 +2/-0	C
	Bulk (Tray) – Long Leads	17 +0/-1	A
	Pizza Pack	4 +2/-0	Z
	Other Lead and Packaging Options		
	Tape & Reel (Standard Reel)	$H_0 = 18.5 \pm 0.5$	L
	Tape & Reel (Large Reel)	$H_0 = 18.5 \pm 0.5$	P
	Ammo Pack	$H_0 = 18.5 \pm 0.5$	R
27.5	Standard Lead and Packaging Options		
	Bulk (Tray) – Short Leads	4 +2/-0	C
	Bulk (Tray) – Long Leads	17 +0/-1	A
	Pizza Pack	4 +2/-0	Z
37.5	Standard Lead and Packaging Options		
	Bulk (Tray) – Short Leads	4 +2/-0	C
	Bulk (Tray) – Long Leads	17 +0/-1	A
	Pizza Pack	4 +2/-0	Z

Dimensions – Millimeters

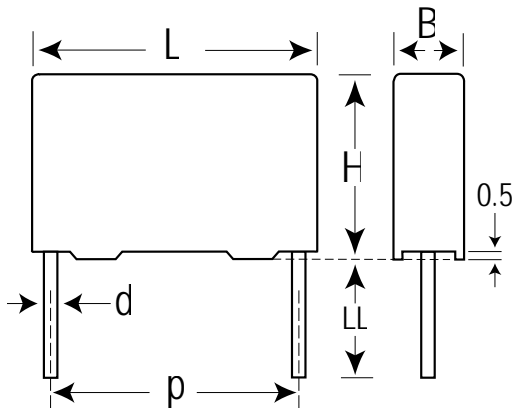

Size Code	p		B		H		L		d	
	Nominal	Tolerance	Nominal	Tolerance	Nominal	Tolerance	Nominal	Tolerance	Nominal	Tolerance
JF	5.0	+/-0.4	2.5	Maximum	6.5	Maximum	7.2	Maximum	0.6	+/-0.05
JG	5.0	+/-0.4	3.5	Maximum	7.5	Maximum	7.2	Maximum	0.6	+/-0.05
JM	5.0	+/-0.4	4.5	Maximum	9.5	Maximum	7.2	Maximum	0.6	+/-0.05
JQ	5.0	+/-0.4	5.0	Maximum	10.0	Maximum	7.2	Maximum	0.6	+/-0.05
JT	5.0	+/-0.4	6.0	Maximum	11.0	Maximum	7.2	Maximum	0.6	+/-0.05
JU	5.0	+/-0.4	7.2	Maximum	13.0	Maximum	7.2	Maximum	0.6	+/-0.05
KE	7.5	+/-0.4	2.5	Maximum	6.0	Maximum	10.0	Maximum	0.6	+/-0.05
KF	7.5	+/-0.4	3.0	Maximum	8.0	Maximum	10.0	Maximum	0.6	+/-0.05
KG	7.5	+/-0.4	4.0	Maximum	8.0	Maximum	10.0	Maximum	0.6	+/-0.05
KH	7.5	+/-0.4	4.0	Maximum	9.0	Maximum	10.0	Maximum	0.6	+/-0.05
KJ	7.5	+/-0.4	5.0	Maximum	10.5	Maximum	10.0	Maximum	0.6	+/-0.05
KM	7.5	+/-0.4	6.0	Maximum	12.0	Maximum	10.5	Maximum	0.6	+/-0.05
AG	10.0	+/-0.4	4.0	Maximum	9.0	Maximum	13.0	Maximum	0.6	+/-0.05
AK	10.0	+/-0.4	5.0	Maximum	11.0	Maximum	13.0	Maximum	0.6	+/-0.05
AP	10.0	+/-0.4	6.0	Maximum	12.0	Maximum	13.0	Maximum	0.6	+/-0.05
BB	15.0	+/-0.4	4.0	Maximum	10.0	Maximum	18.0	Maximum	0.8	+/-0.05
BC	15.0	+/-0.4	5.0	Maximum	11.0	Maximum	18.0	Maximum	0.8	+/-0.05
BE	15.0	+/-0.4	5.5	Maximum	12.5	Maximum	18.0	Maximum	0.8	+/-0.05
BG	15.0	+/-0.4	6.0	Maximum	12.0	Maximum	18.0	Maximum	0.8	+/-0.05
BK	15.0	+/-0.4	7.5	Maximum	13.5	Maximum	18.0	Maximum	0.8	+/-0.05
BP	15.0	+/-0.4	8.5	Maximum	14.5	Maximum	18.0	Maximum	0.8	+/-0.05
BS	15.0	+/-0.4	10.0	Maximum	16.0	Maximum	18.0	Maximum	0.8	+/-0.05
BY	15.0	+/-0.4	11.0	Maximum	19.0	Maximum	18.0	Maximum	0.8	+/-0.05
DB	22.5	+/-0.4	6.0	Maximum	14.5	Maximum	26	Maximum	0.8	+/-0.05
DI	22.5	+/-0.4	7.0	Maximum	16.0	Maximum	26.0	Maximum	0.8	+/-0.05
DH	22.5	+/-0.4	8.0	Maximum	16.0	Maximum	26.0	Maximum	0.8	+/-0.05
DJ	22.5	+/-0.4	8.5	Maximum	17.0	Maximum	26.0	Maximum	0.8	+/-0.05
DM	22.5	+/-0.4	9.0	Maximum	18.5	Maximum	26.0	Maximum	0.8	+/-0.05
DO	22.5	+/-0.4	10.0	Maximum	18.5	Maximum	26.0	Maximum	0.8	+/-0.05
DP	22.5	+/-0.4	11.0	Maximum	20.0	Maximum	26.0	Maximum	0.8	+/-0.05

Note: See Ordering Options Table for lead length (LL) options.

Dimensions – Millimeters cont'd

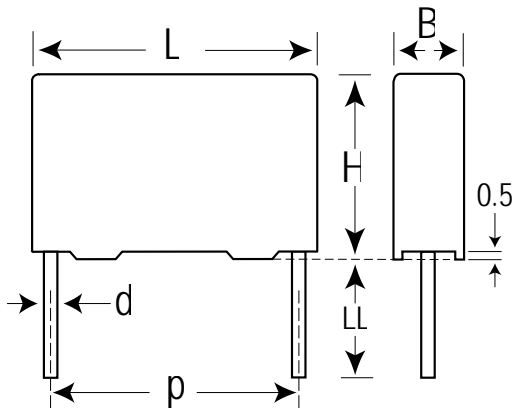

Size Code	p		B		H		L		d	
	Nominal	Tolerance	Nominal	Tolerance	Nominal	Tolerance	Nominal	Tolerance	Nominal	Tolerance
DU	22.5	+/-0.4	13.0	Maximum	22.0	Maximum	26.0	Maximum	0.8	+/-0.05
DY	22.5	+/-0.4	15.5	Maximum	24.5	Maximum	26.0	Maximum	0.8	+/-0.05
FB	27.5	+/-0.4	9.0	Maximum	17.0	Maximum	31.5	Maximum	0.8	+/-0.05
FC	27.5	+/-0.4	11.0	Maximum	20.0	Maximum	31.5	Maximum	0.8	+/-0.05
FI	27.5	+/-0.4	13.0	Maximum	25.0	Maximum	31.5	Maximum	0.8	+/-0.05
FN	27.5	+/-0.4	14.0	Maximum	28.0	Maximum	31.5	Maximum	0.8	+/-0.05
FR	27.5	+/-0.4	17.5	Maximum	28.0	Maximum	31.5	Maximum	0.8	+/-0.05
FS	27.5	+/-0.4	19.0	Maximum	29.0	Maximum	31.5	Maximum	0.8	+/-0.05
FY	27.5	+/-0.4	22.0	Maximum	37.0	Maximum	31.5	Maximum	0.8	+/-0.05
RB	37.5	+/-0.4	11.0	Maximum	22.0	Maximum	41.0	Maximum	1	+/-0.05
RF	37.5	+/-0.4	13.0	Maximum	24.0	Maximum	41.0	Maximum	1	+/-0.05
RH	37.5	+/-0.4	15.0	Maximum	26.0	Maximum	41.0	Maximum	1	+/-0.05
RC	37.5	+/-0.4	16.0	Maximum	28.5	Maximum	41.0	Maximum	1	+/-0.05
RD	37.5	+/-0.4	19.0	Maximum	32.0	Maximum	41.0	Maximum	1	+/-0.05
RP	37.5	+/-0.4	21.0	Maximum	38.0	Maximum	41.0	Maximum	1	+/-0.05
RO	37.5	+/-0.4	24.0	Maximum	44.0	Maximum	41.0	Maximum	1	+/-0.05
RU	37.5	+/-0.4	30.0	Maximum	45.0	Maximum	41.0	Maximum	1	+/-0.05

Note: See Ordering Options Table for lead length (LL) options.

Performance Characteristics

Voltage Range V_R (VDC)	50	63	100	160	250	400	630	1,000
Voltage Range V_R (VAC)	30	40	63	90	160/140	200/160	220	250
Capacitance Range (μF)	0.27 – 15	0.1 – 330	0.001 – 220	0.18 – 180	0.0068 – 82	0.001 – 33	0.0012 – 12	0.001 – 5.6
Capacitance Tolerance	$\pm 10\%$, $\pm 20\%$, $\pm 5\%$ on request							
Category Temperature Range	-55°C to +105°C							
Voltage Derating	Above +85°C DC and AC voltage derating is 1.25%/°C							
Rated Temperature	+85°C							
Climatic Category	IEC60068-1, 55/105/56							
	-55 to +105°C (For +125°C, please consult KEMET)							
	Average relative humidity $\leq 75\%$							
	RH = 95% for 30 days per year							
	RH = 85% for further days limited by average value per year							
Test Voltage	1.6 x V_R VDC for 2 seconds							
Capacitance Drift	Maximum 2% after a 2 year storage period at a temperature of +10°C to +40°C and a relative humidity of 40% to 60%							
Reliability	Operational life > 200,000 hours							
	Failure rate < 3 FIT, T = +40°C, V = 0.5 x V_R							
	Failure criteria: open circuit, short circuit, cap change > 10%, DF 2 times the catalog limits, IR < 50 M Ω							
Maximum Pulse Steepness	dV/dt according to Table 1. For peak voltages lower than rated voltage ($V_{pp} < V_R$), the specified dV/dt can be multiplied by the factor V_R/V_{pp} .							
Temperature Coefficient	+400 (± 200) ppm/°C at 1 kHz							
Self Inductance	Approximately 6 nH/cm for the total length of capacitor winding and the leads							
Dissipation Factor $\tan\delta$	Maximum Values at +23°C							
			$C \leq 0.1 \mu\text{F}$	$0.1 \mu\text{F} < C \leq 1.0 \mu\text{F}$	$C > 1.0 \mu\text{F}$			
Lead Spacing 5 mm	1 kHz		0.8%	0.8%	0.8%			
	10 kHz		1.2%	1.2%	1.5%			
	100 kHz		2.5%					
Lead Spacing 7.5 – 37.5 mm	1 kHz		0.8%	0.8%	1.2%			
	10 kHz		1.5%	1.5%				
	100 kHz		3.0%					
Insulation Resistance	Measured at +20°C, according to IEC 60384-2							
	Minimum Values Between Terminals							
			$C \leq 0.33 \mu\text{F}$	$C > 0.33 \mu\text{F}$				
	$V_R \leq 100$ VDC		15,000 M Ω	5,000 M $\Omega \cdot \mu\text{F}$				
	$V_R > 100$ VDC		30,000 M Ω	10,000 M $\Omega \cdot \mu\text{F}$				

Maximum Voltage (V_{rms}) vs. Frequency (Sinusoidal Waveform/ $T \leq 40^\circ\text{C}$)

Lead Spacing 5 mm

Vrms [V] 50 Vdc / 30 Vac

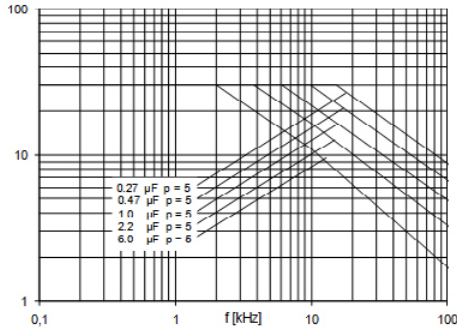

Vrms [V] 63 Vdc / 40 Vac

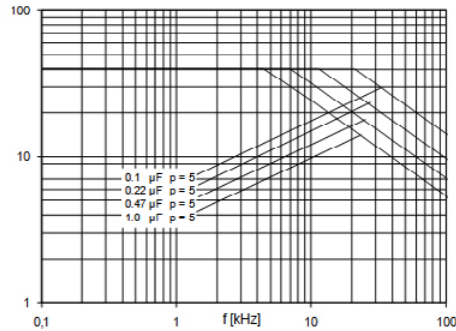

Vrms [V] 100 Vdc / 63 Vac

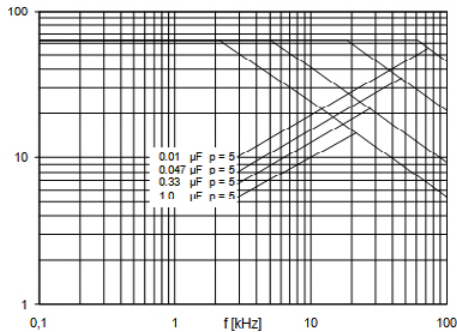

Vrms [V] 250 Vdc / 160 Vac

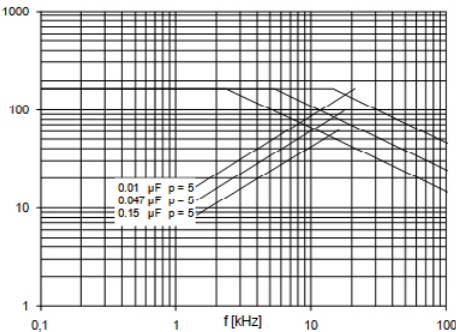

Vrms [V] 250 Vdc / 140 Vac - Reduced Sizes

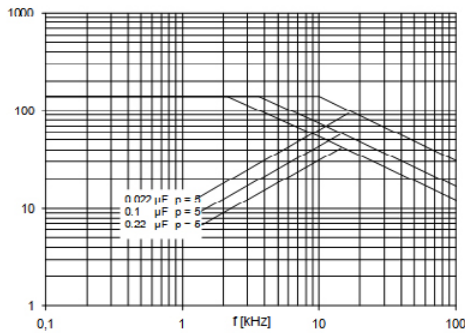

Vrms [V] 400 Vdc / 200 Vac

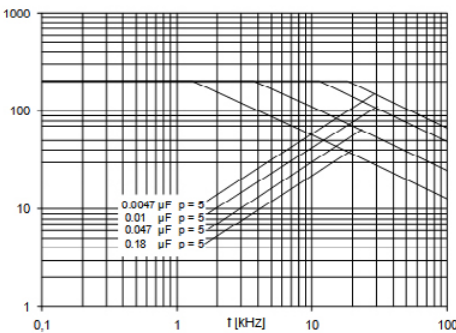

Vrms [V] 630 Vdc / 220 Vac

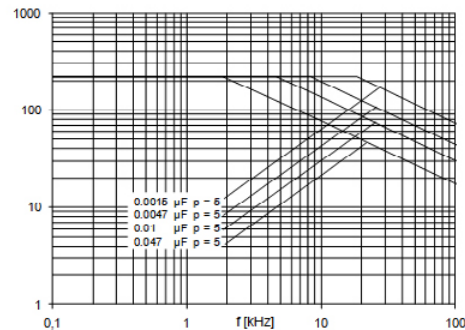

Vrms [V] 1000 Vdc / 250 Vac

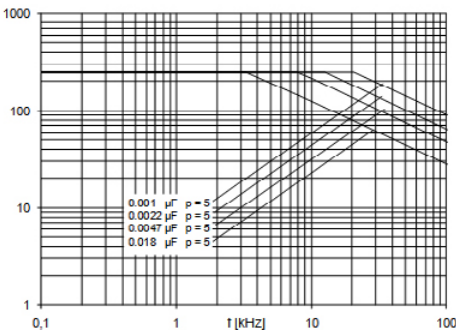

Maximum Voltage (V_{rms}) vs. Frequency (Sinusoidal Waveform/ $T \leq 40^\circ\text{C}$)

Lead Spacing 7.5 mm

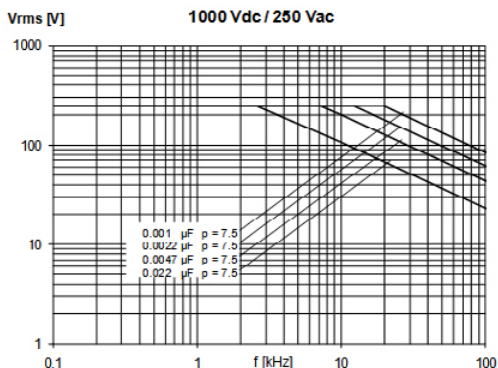
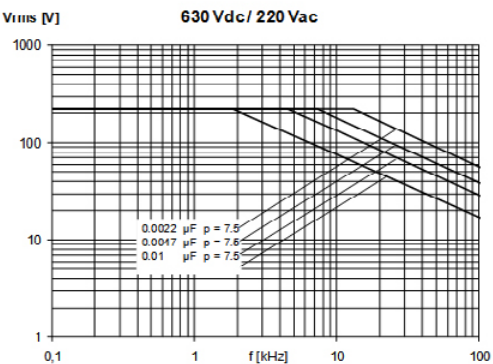
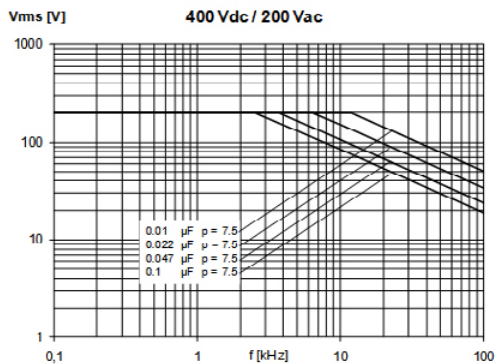
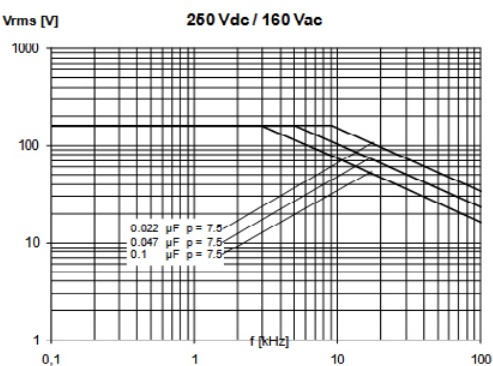
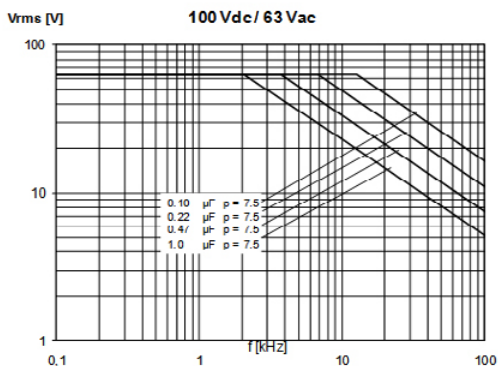
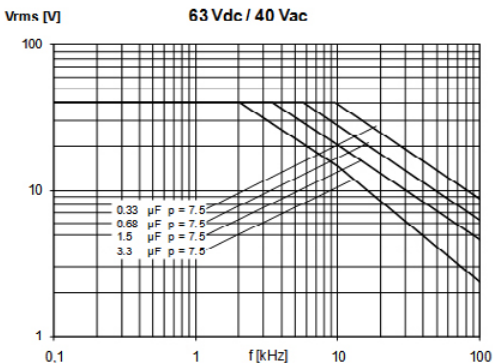
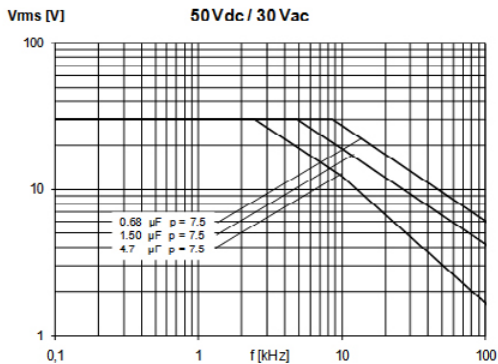

Maximum Voltage (V_{rms}) vs. Frequency (Sinusoidal Waveform/ $T \leq 40^\circ\text{C}$)

Lead Spacing 10 – 37.5 mm

Vrms [V] 50 Vdc / 30 Vac

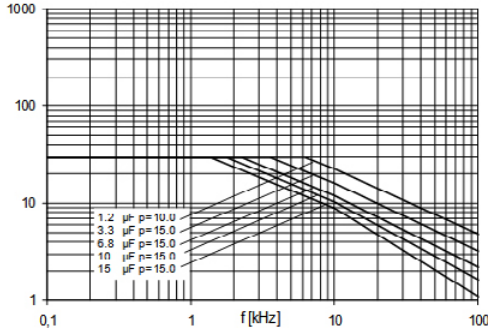

Vrms [V] 63 Vdc / 40 Vac

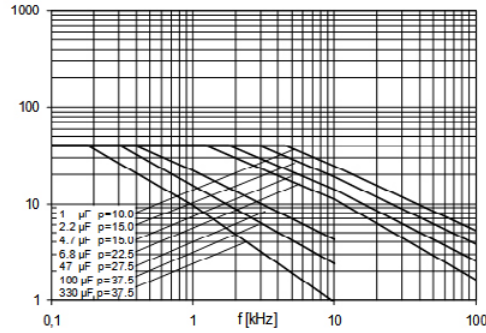

Vrms [V] 100 Vdc / 63 Vac

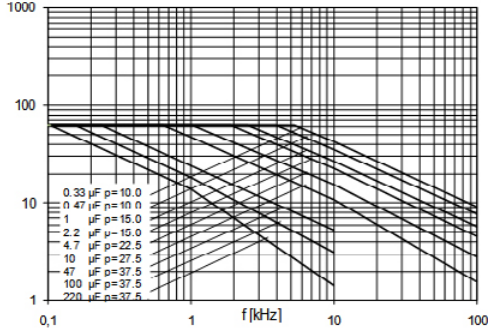

Vrms [V] 160 Vdc / 90 Vac

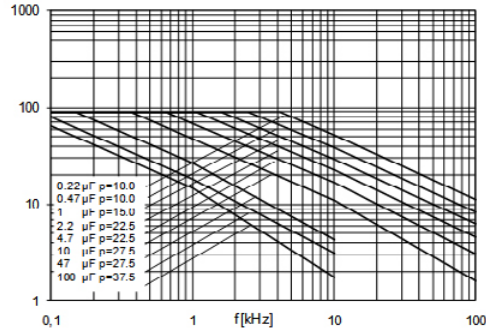

Vrms [V] 250 Vdc / 160 Vac

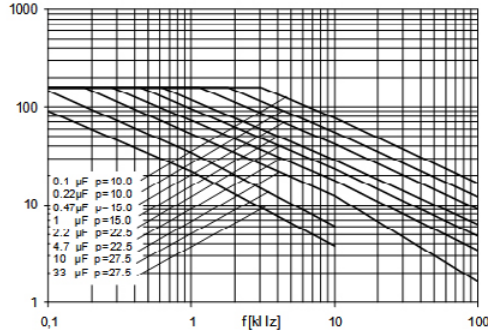

Vrms [V] 400 Vdc / 200 Vac

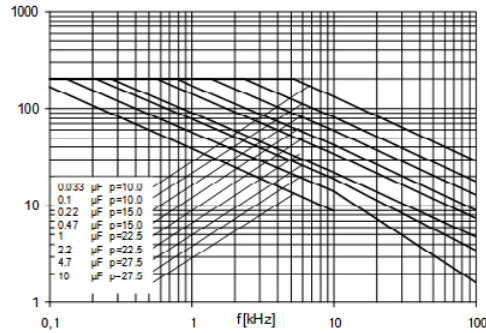

Vrms [V] 630 Vdc / 220 Vac

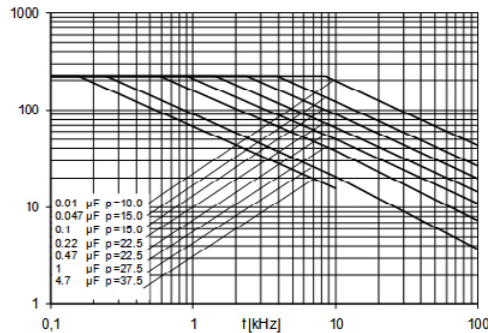

Vrms [V] 1000 Vdc / 250 Vac

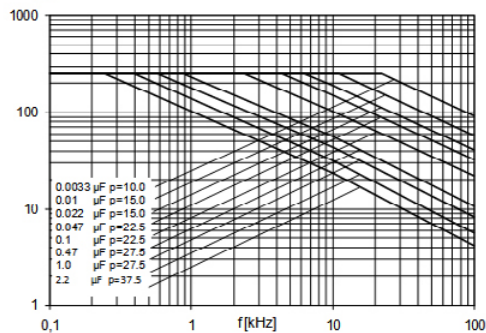

Maximum Current (I_{rms}) vs. Frequency (Sinusoidal Waveform/ $T \leq 40^\circ\text{C}$)

Lead Spacing 5 mm

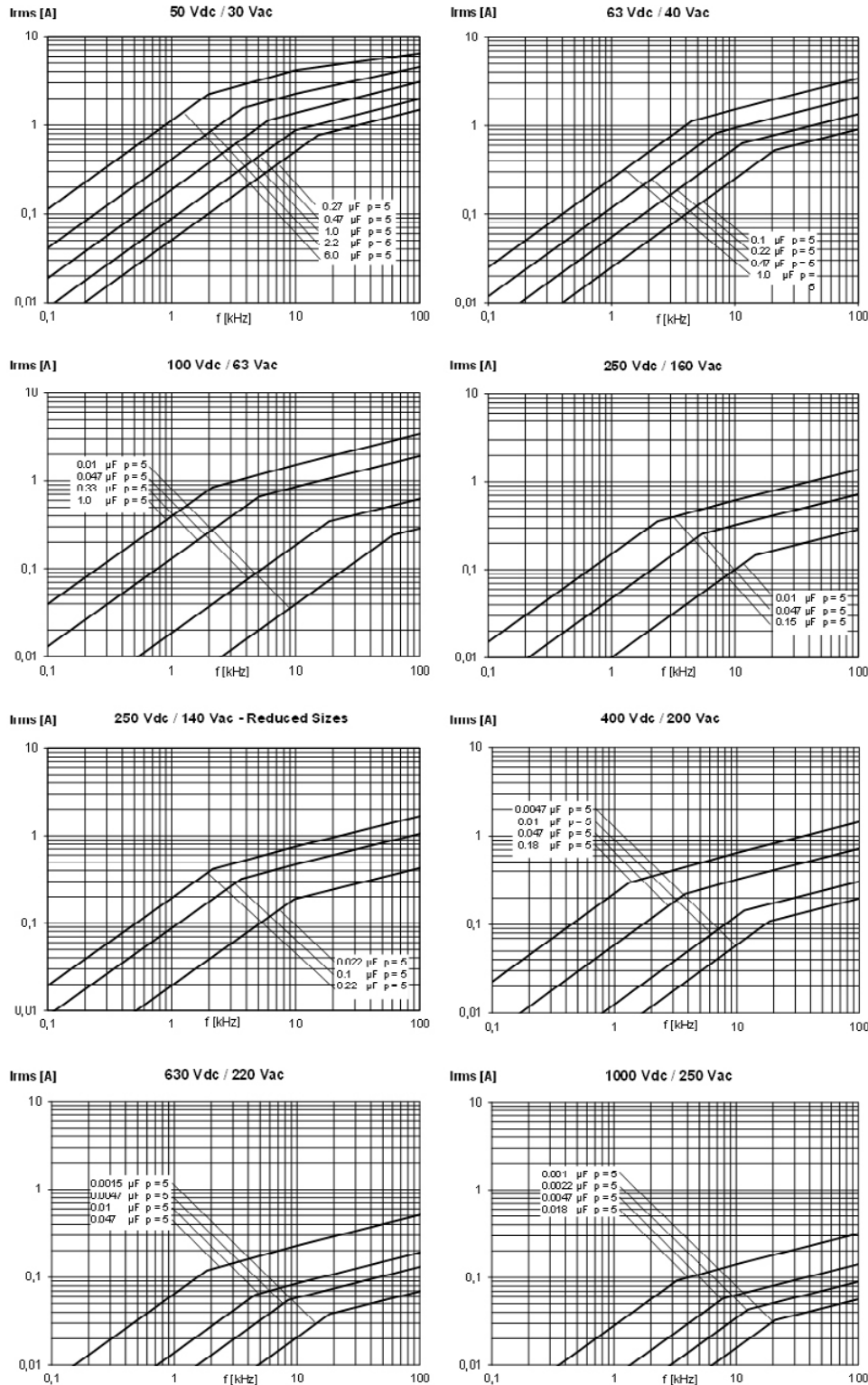

Maximum Current (I_{rms}) vs. Frequency (Sinusoidal Waveform/ $T \leq 40^\circ\text{C}$)

Lead Spacing 7.5 mm

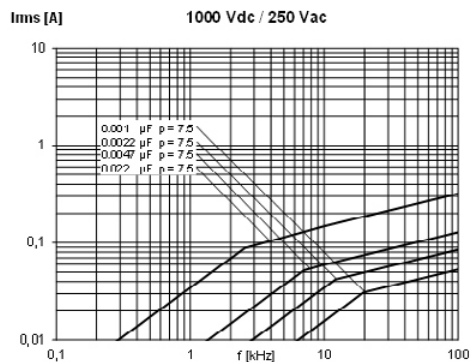
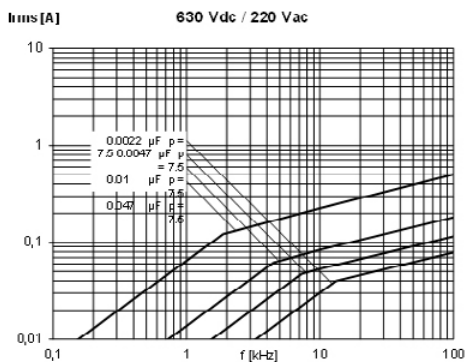
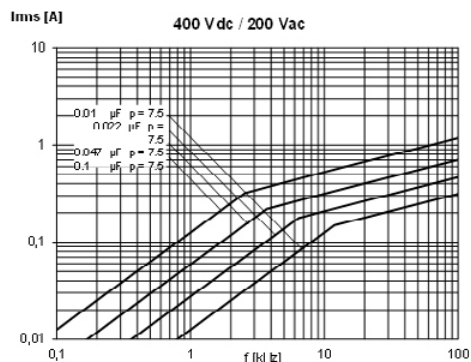
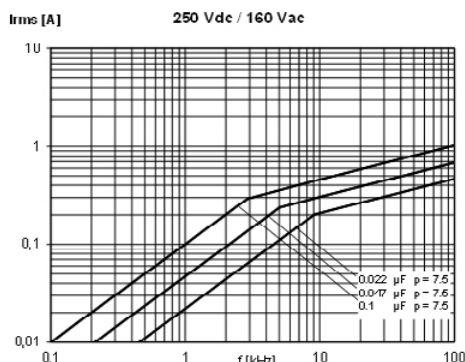
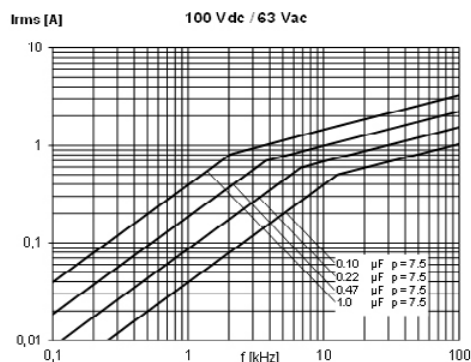
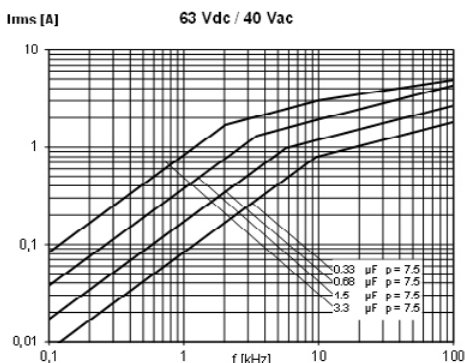
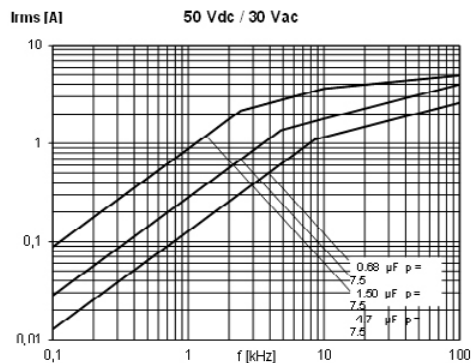

Maximum Current (I_{rms}) vs. Frequency (Sinusoidal Waveform/ $T \leq 40^\circ\text{C}$)

Lead Spacing 10 – 37.5 mm

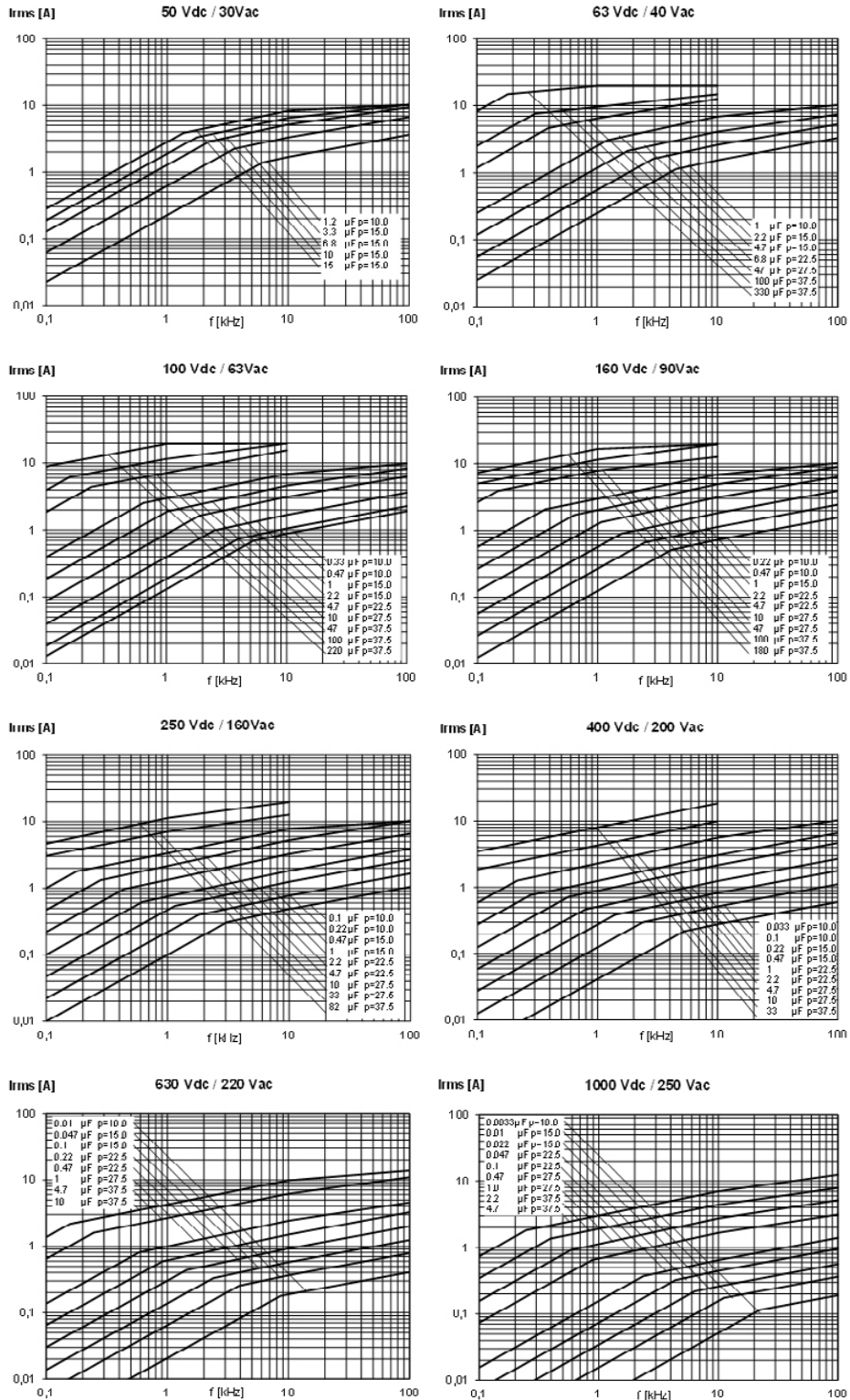

Environmental Test Data

Damp Heat Test	Test Conditions	T = +40°C, RH = 93%, t = 56 days
	Test Criteria	$\Delta C/C \leq \pm 5\%$ $\Delta \tan\delta \leq 0.005$ (1 kHz) IR after test 0.5 x IR minimum
Endurance Test	Test Conditions	T = +100°C, U = 1.25 x (0.8 x U _R)
	Test Criteria	t = 2,000 hours $\Delta C/C \leq \pm 5\%$, $\Delta \tan\delta \leq 0.005$ (1 kHz) $\Delta \tan\delta \leq 0.010$ (100 kHz) IR after test 0.5 x IR minimum

Environmental Compliance

All KEMET MKTI capacitors are RoHS Compliant.



RoHS Compliant

Table 1 – Ratings & Part Number Reference

VDC	VAC	Capacitance Value (µF)	Size Code	Maximum Dimensions in mm			Lead Spacing (p)	dV/dt (V/µs)	Part Number
				B	H	L			
50	30	0.27	JF	2.5	6.5	7.2	5.0	12	F611JF274(1)050(2)
50	30	0.33	JF	2.5	6.5	7.2	5.0	12	F611JF334(1)050(2)
50	30	0.39	JF	2.5	6.5	7.2	5.0	12	F611JF394(1)050(2)
50	30	0.47	JF	2.5	6.5	7.2	5.0	12	F611JF474(1)050(2)
50	30	0.56	JG	3.5	7.5	7.2	5.0	12	F611JG564(1)050(2)
50	30	0.68	JG	3.5	7.5	7.2	5.0	12	F611JG684(1)050(2)
50	30	0.82	JG	3.5	7.5	7.2	5.0	12	F611JG824(1)050(2)
50	30	1	JG	3.5	7.5	7.2	5.0	12	F611JG105(1)050(2)
50	30	1.2	JM	4.5	9.5	7.2	5.0	12	F611JM125(1)050(2)
50	30	1.5	JM	4.5	9.5	7.2	5.0	12	F611JM155(1)050(2)
50	30	1.8	JQ	5	10	7.2	5.0	12	F611JQ185(1)050(2)
50	30	2.2	JQ	5	10	7.2	5.0	12	F611JQ225(1)050(2)
50	30	2.7	JT	6	11	7.2	5.0	12	F611JT275(1)050(2)
50	30	3.3	JT	6	11	7.2	5.0	12	F611JT335(1)050(2)
50	30	3.9	JU	7.2	13	7.2	5.0	12	F611JU395(1)050(2)
50	30	4.7	JU	7.2	13	7.2	5.0	12	F611JU475(1)050(2)
50	30	5.6	JU	7.2	13	7.2	5.0	12	F611JU565(1)050(2)
50	30	6	JU	7.2	13	7.2	5.0	12	F611JU605(1)050(2)
50	30	0.68	KF	3	8	10	7.5	100	F612KF684(1)050(2)
50	30	0.82	KF	3	8	10	7.5	100	F612KF824(1)050(2)
50	30	1	KF	3	8	10	7.5	100	F612KF105(1)050(2)
50	30	1.2	KH	4	9	10	7.5	100	F612KH125(1)050(2)
50	30	1.5	KH	4	9	10	7.5	100	F612KH155(1)050(2)
50	30	1.8	KJ	5	10.5	10	7.5	100	F612KJ185(1)050(2)
50	30	2.2	KJ	5	10.5	10	7.5	100	F612KJ225(1)050(2)
50	30	2.7	KJ	5	10.5	10	7.5	100	F612KJ275(1)050(2)
50	30	3.3	KJ	5	10.5	10	7.5	100	F612KJ335(1)050(2)
50	30	3.9	KM	6	12	10.5	7.5	100	F612KM395(1)050(2)
50	30	4.7	KM	6	12	10.5	7.5	100	F612KM475(1)050(2)
50	30	1.2	AG	4	9	13	10.0	30	F612AG125(1)050(2)
50	30	1.5	AG	4	9	13	10.0	30	F612AG155(1)050(2)
50	30	1.8	AG	4	9	13	10.0	30	F612AG185(1)050(2)
50	30	2.2	AG	4	9	13	10.0	30	F612AG225(1)050(2)
50	30	2.7	AK	5	11	13	10.0	30	F612AK275(1)050(2)
50	30	3.3	AK	5	11	13	10.0	30	F612AK335(1)050(2)
50	30	3.9	AK	5	11	13	10.0	30	F612AK395(1)050(2)
50	30	4.7	AP	6	12	13	10.0	30	F612AP475(1)050(2)
50	30	5.6	AP	6	12	13	10.0	30	F612AP565(1)050(2)
50	30	1.8	BB	4	10	18	15.0	3	F611BB185(1)050(2)
50	30	2.2	BC	5	11	18	15.0	3	F611BC225(1)050(2)
50	30	2.7	BC	5	11	18	15.0	3	F611BC275(1)050(2)
50	30	3.3	BE	5.5	12.5	18	15.0	3	F611BE335(1)050(2)
50	30	3.9	BE	5.5	12.5	18	15.0	3	F611BE395(1)050(2)
50	30	4.7	BK	7.5	13.5	18	15.0	3	F611BK475(1)050(2)
50	30	5.6	BK	7.5	13.5	18	15.0	3	F611BK565(1)050(2)
50	30	6.8	BP	8.5	14.5	18	15.0	3	F611BP685(1)050(2)
50	30	8.2	BP	8.5	14.5	18	15.0	3	F611BP825(1)050(2)
50	30	10	BS	10	16	18	15.0	3	F611BS106(1)050(2)
50	30	12	BY	11	19	18	15.0	3	F611BY126(1)050(2)
50	30	15	BY	11	19	18	15.0	3	F611BY156(1)050(2)
63	40	0.1	JF	2.5	6.5	7.2	5.0	160	F612JF104(1)063(2)
63	40	0.12	JF	2.5	6.5	7.2	5.0	160	F612JF124(1)063(2)
63	40	0.15	JF	2.5	6.5	7.2	5.0	160	F612JF154(1)063(2)
63	40	0.18	JF	2.5	6.5	7.2	5.0	160	F612JF184(1)063(2)
63	40	0.22	JF	2.5	6.5	7.2	5.0	160	F612JF224(1)063(2)
63	40	0.27	JG	3.5	7.5	7.2	5.0	160	F612JG274(1)063(2)
63	40	0.33	JG	3.5	7.5	7.2	5.0	160	F612JG334(1)063(2)
63	40	0.39	JG	3.5	7.5	7.2	5.0	160	F612JG394(1)063(2)
63	40	0.47	JG	3.5	7.5	7.2	5.0	160	F612JG474(1)063(2)
63	40	0.56	JM	4.5	9.5	7.2	5.0	160	F612JM564(1)063(2)
VDC	VAC	Capacitance Value (µF)	Size Code	B (mm)	H (mm)	L (mm)	Lead Spacing (p)	dV/dt (V/µs)	Part Number

(1) K= ±10%, M = ±20%, J = ±5% on request.

(2) Insert lead and packaging code. See table for available options.

Table 1 – Ratings & Part Number Reference cont'd

VDC	VAC	Capacitance Value (µF)	Size Code	Maximum Dimensions in mm			Lead Spacing (p)	dV/dt (V/µs)	Part Number
				B	H	L			
63	40	0.68	JM	4.5	9.5	7.2	5.0	160	F612JM684(1)063(2)
63	40	0.82	JM	4.5	9.5	7.2	5.0	160	F612JM824(1)063(2)
63	40	1	JQ	5	10	7.2	5.0	160	F612JQ105(1)063(2)
63	40	1.2	JT	6	11	7.2	5.0	160	F612JT125(1)063(2)
63	40	1.5	JT	6	11	7.2	5.0	160	F612JT155(1)063(2)
63	40	0.33	KF	3	8	10	7.5	120	F612KF334(1)063(2)
63	40	0.39	KF	3	8	10	7.5	120	F612KF394(1)063(2)
63	40	0.47	KF	3	8	10	7.5	120	F612KF474(1)063(2)
63	40	0.56	KH	4	9	10	7.5	120	F612KH564(1)063(2)
63	40	0.68	KH	4	9	10	7.5	120	F612KH684(1)063(2)
63	40	0.82	KH	4	9	10	7.5	120	F612KH824(1)063(2)
63	40	1	KH	4	9	10	7.5	120	F612KH105(1)063(2)
63	40	1.2	KJ	5	10.5	10	7.5	120	F612KJ125(1)063(2)
63	40	1.5	KJ	5	10.5	10	7.5	120	F612KJ155(1)063(2)
63	40	1.8	KM	6	12	10.5	7.5	120	F612KM185(1)063(2)
63	40	2.2	KM	6	12	10.5	7.5	120	F612KM225(1)063(2)
63	40	2.7	KM	6	12	10.5	7.5	120	F612KM275(1)063(2)
63	40	3.3	KM	6	12	10.5	7.5	120	F612KM335(1)063(2)
63	40	1	AG	4	9	13	10.0	50	F612AG105(1)063(2)
63	40	1.2	AG	4	9	13	10.0	50	F612AG125(1)063(2)
63	40	1.5	AK	5	11	13	10.0	50	F612AK155(1)063(2)
63	40	1.8	AK	5	11	13	10.0	50	F612AK185(1)063(2)
63	40	2.2	AK	5	11	13	10.0	50	F612AK225(1)063(2)
63	40	2.7	AK	5	11	13	10.0	50	F612AK275(1)063(2)
63	40	3.3	AP	6	12	13	10.0	50	F612AP335(1)063(2)
63	40	3.9	AP	6	12	13	10.0	50	F612AP395(1)063(2)
63	40	1.2	BB	4	10	18	15.0	5	F611BB125(1)063(2)
63	40	1.5	BB	4	10	18	15.0	5	F611BB155(1)063(2)
63	40	1.8	BC	5	11	18	15.0	5	F611BC185(1)063(2)
63	40	2.2	BE	5.5	12.5	18	15.0	5	F611BE225(1)063(2)
63	40	2.7	BE	5.5	12.5	18	15.0	5	F611BE275(1)063(2)
63	40	3.3	BG	6	12	18	15.0	5	F611BG335(1)063(2)
63	40	3.9	BK	7.5	13.5	18	15.0	5	F611BK395(1)063(2)
63	40	4.7	BK	7.5	13.5	18	15.0	5	F611BK475(1)063(2)
63	40	5.6	BP	8.5	14.5	18	15.0	5	F611BP565(1)063(2)
63	40	6.8	BP	8.5	14.5	18	15.0	5	F611BP685(1)063(2)
63	40	8.2	BS	10	16	18	15.0	5	F611BS825(1)063(2)
63	40	10	BS	10	16	18	15.0	5	F611BS106(1)063(2)
63	40	12	BY	11	19	18	15.0	5	F611BY126(1)063(2)
63	40	4.7	DB	6	14.5	26	22.5	3	F611DB475(1)063(2)
63	40	5.6	DB	6	14.5	26	22.5	3	F611DB565(1)063(2)
63	40	6.8	DI	7	16	26	22.5	3	F611DI685(1)063(2)
63	40	8.2	DI	7	16	26	22.5	3	F611DI825(1)063(2)
63	40	10	DJ	8.5	17	26	22.5	3	F611DJ106(1)063(2)
63	40	12	DM	9	18.5	26	22.5	3	F611DM126(1)063(2)
63	40	15	DO	10	18.5	26	22.5	3	F611DO156(1)063(2)
63	40	18	DP	11	20	26	22.5	3	F611DP186(1)063(2)
63	40	22	DU	13	22	26	22.5	3	F611DU226(1)063(2)
63	40	27	DY	15.5	24.5	26	22.5	3	F611DY276(1)063(2)
63	40	33	DY	15.5	24.5	26	22.5	3	F611DY336(1)063(2)
63	40	15	FB	9	17	31.5	27.5	2	F611FB156(1)063(2)
63	40	18	FC	11	20	31.5	27.5	2	F611FC186(1)063(2)
63	40	22	FC	11	20	31.5	27.5	2	F611FC226(1)063(2)
63	40	27	FI	13	25	31.5	27.5	2	F611FI276(1)063(2)
63	40	33	FI	13	25	31.5	27.5	2	F611FI336(1)063(2)
63	40	39	FN	14	28	31.5	27.5	2	F611FN396(1)063(2)
63	40	47	FR	17.5	28	31.5	27.5	2	F611FR476(1)063(2)
63	40	56	FS	19	29	31.5	27.5	2	F611FS566(1)063(2)
63	40	68	FY	22	37	31.5	27.5	2	F611FY686(1)063(2)
63	40	82	FY	22	37	31.5	27.5	2	F611FY826(1)063(2)
VDC	VAC	Capacitance Value (µF)	Size Code	B (mm)	H (mm)	L (mm)	Lead Spacing (p)	dV/dt (V/µs)	Part Number

(1) K = ±10%, M = ±20%, J = ±5% on request.

(2) Insert lead and packaging code. See table for available options.

Table 1 – Ratings & Part Number Reference cont'd

VDC	VAC	Capacitance Value (µF)	Size Code	Maximum Dimensions in mm			Lead Spacing (p)	dV/dt (V/µs)	Part Number
				B	H	L			
63	40	100	FY	22	37	31.5	27.5	2	F611FY107(1)063(2)
63	40	33	RB	11	22	41	37.5	1	F611RB336(1)063(2)
63	40	39	RF	13	24	41	37.5	1	F611RF396(1)063(2)
63	40	47	RF	13	24	41	37.5	1	F611RF476(1)063(2)
63	40	56	RH	15	26	41	37.5	1	F611RH566(1)063(2)
63	40	68	RC	16	28.5	41	37.5	1	F611RC686(1)063(2)
63	40	82	RD	19	32	41	37.5	1	F611RD826(1)063(2)
63	40	100	RD	19	32	41	37.5	1	F611RD107(1)063(2)
63	40	120	RP	21	38	41	37.5	1	F611RP127(1)063(2)
63	40	150	RP	21	38	41	37.5	1	F611RP157(1)063(2)
63	40	180	RO	24	44	41	37.5	1	F611RO187(1)063(2)
63	40	220	RU	30	45	41	37.5	1	F611RU227(1)063(2)
63	40	270	RU	30	45	41	37.5	1	F611RU277(1)063(2)
100	63	0.001	JF	2.5	6.5	7.2	5.0	200	F612JF102(1)100(2)
100	63	0.0012	JF	2.5	6.5	7.2	5.0	200	F612JF122(1)100(2)
100	63	0.0015	JF	2.5	6.5	7.2	5.0	200	F612JF152(1)100(2)
100	63	0.0018	JF	2.5	6.5	7.2	5.0	200	F612JF182(1)100(2)
100	63	0.0022	JF	2.5	6.5	7.2	5.0	200	F612JF222(1)100(2)
100	63	0.0027	JF	2.5	6.5	7.2	5.0	200	F612JF272(1)100(2)
100	63	0.0033	JF	2.5	6.5	7.2	5.0	200	F612JF332(1)100(2)
100	63	0.0039	JF	2.5	6.5	7.2	5.0	200	F612JF392(1)100(2)
100	63	0.0047	JF	2.5	6.5	7.2	5.0	200	F612JF472(1)100(2)
100	63	0.0056	JF	2.5	6.5	7.2	5.0	200	F612JF562(1)100(2)
100	63	0.0068	JF	2.5	6.5	7.2	5.0	200	F612JF682(1)100(2)
100	63	0.0082	JF	2.5	6.5	7.2	5.0	200	F612JF822(1)100(2)
100	63	0.01	JF	2.5	6.5	7.2	5.0	200	F612JF103(1)100(2)
100	63	0.012	JF	2.5	6.5	7.2	5.0	200	F612JF123(1)100(2)
100	63	0.015	JF	2.5	6.5	7.2	5.0	200	F612JF153(1)100(2)
100	63	0.018	JF	2.5	6.5	7.2	5.0	200	F612JF183(1)100(2)
100	63	0.022	JF	2.5	6.5	7.2	5.0	200	F612JF223(1)100(2)
100	63	0.027	JF	2.5	6.5	7.2	5.0	200	F612JF273(1)100(2)
100	63	0.033	JF	2.5	6.5	7.2	5.0	200	F612JF333(1)100(2)
100	63	0.039	JF	2.5	6.5	7.2	5.0	200	F612JF393(1)100(2)
100	63	0.047	JF	2.5	6.5	7.2	5.0	200	F612JF473(1)100(2)
100	63	0.056	JF	2.5	6.5	7.2	5.0	200	F612JF563(1)100(2)
100	63	0.068	JF	2.5	6.5	7.2	5.0	200	F612JF683(1)100(2)
100	63	0.082	JF	2.5	6.5	7.2	5.0	200	F612JF823(1)100(2)
100	63	0.1	JF	2.5	6.5	7.2	5.0	200	F612JF104(1)100(2)
100	63	0.12	JF	2.5	6.5	7.2	5.0	200	F612JF124(1)100(2)
100	63	0.15	JG	3.5	7.5	7.2	5.0	200	F612JG154(1)100(2)
100	63	0.18	JG	3.5	7.5	7.2	5.0	200	F612JG184(1)100(2)
100	63	0.22	JG	3.5	7.5	7.2	5.0	200	F612JG224(1)100(2)
100	63	0.27	JG	3.5	7.5	7.2	5.0	200	F612JG274(1)100(2)
100	63	0.33	JM	4.5	9.5	7.2	5.0	200	F612JM334(1)100(2)
100	63	0.39	JM	4.5	9.5	7.2	5.0	200	F612JM394(1)100(2)
100	63	0.47	JM	4.5	9.5	7.2	5.0	200	F612JM474(1)100(2)
100	63	0.56	JQ	5	10	7.2	5.0	200	F612JQ564(1)100(2)
100	63	0.68	JQ	5	10	7.2	5.0	200	F612JQ684(1)100(2)
100	63	0.82	JT	6	11	7.2	5.0	200	F612JT824(1)100(2)
100	63	1	JT	6	11	7.2	5.0	200	F612JT105(1)100(2)
100	63	0.068	KF	3	8	10	7.5	150	F612KF683(1)100(2)
100	63	0.082	KF	3	8	10	7.5	150	F612KF823(1)100(2)
100	63	0.1	KF	3	8	10	7.5	150	F612KF104(1)100(2)
100	63	0.12	KF	3	8	10	7.5	150	F612KF124(1)100(2)
100	63	0.15	KF	3	8	10	7.5	150	F612KF154(1)100(2)
100	63	0.18	KF	3	8	10	7.5	150	F612KF184(1)100(2)
100	63	0.22	KF	3	8	10	7.5	150	F612KF224(1)100(2)
100	63	0.27	KH	4	9	10	7.5	150	F612KH274(1)100(2)
100	63	0.33	KH	4	9	10	7.5	150	F612KH334(1)100(2)
100	63	0.39	KH	4	9	10	7.5	150	F612KH394(1)100(2)
VDC	VAC	Capacitance Value (µF)	Size Code	B (mm)	H (mm)	L (mm)	Lead Spacing (p)	dV/dt (V/µs)	Part Number

(1) K = ±10%, M = ±20%, J = ±5% on request.

(2) Insert lead and packaging code. See table for available options.

Table 1 – Ratings & Part Number Reference cont'd

VDC	VAC	Capacitance Value (µF)	Size Code	Maximum Dimensions in mm			Lead Spacing (p)	dV/dt (V/µs)	Part Number
				B	H	L			
100	63	0.47	KH	4	9	10	7.5	150	F612KH474(1)100(2)
100	63	0.56	KH	4	9	10	7.5	150	F612KH564(1)100(2)
100	63	0.68	KH	4	9	10	7.5	150	F612KH684(1)100(2)
100	63	0.82	KJ	5	10.5	10	7.5	150	F612KJ824(1)100(2)
100	63	1	KJ	5	10.5	10	7.5	150	F612KJ105(1)100(2)
100	63	1.5	KM	6	12	10.5	7.5	150	F612KM155(1)100(2)
100	63	1.8	KM	6	12	10.5	7.5	150	F612KM185(1)100(2)
100	63	0.33	AG	4	9	13	10.0	75	F612AG334(1)100(2)
100	63	0.39	AG	4	9	13	10.0	75	F612AG394(1)100(2)
100	63	0.47	AG	4	9	13	10.0	75	F612AG474(1)100(2)
100	63	0.56	AG	4	9	13	10.0	75	F612AG564(1)100(2)
100	63	0.68	AG	4	9	13	10.0	75	F612AG684(1)100(2)
100	63	0.82	AG	4	9	13	10.0	75	F612AG824(1)100(2)
100	63	1	AK	5	11	13	10.0	75	F612AK105(1)100(2)
100	63	1.2	AK	5	11	13	10.0	75	F612AK125(1)100(2)
100	63	1.5	AK	5	11	13	10.0	75	F612AK155(1)100(2)
100	63	1.8	AP	6	12	13	10.0	75	F612AP185(1)100(2)
100	63	0.56	BB	4	10	18	15.0	8	F611BB564(1)100(2)
100	63	0.68	BB	4	10	18	15.0	8	F611BB684(1)100(2)
100	63	0.82	BB	4	10	18	15.0	8	F611BB824(1)100(2)
100	63	1	BB	4	10	18	15.0	8	F611BB105(1)100(2)
100	63	1.2	BC	5	11	18	15.0	8	F611BC125(1)100(2)
100	63	1.5	BC	5	11	18	15.0	8	F611BC155(1)100(2)
100	63	1.8	BE	5.5	12.5	18	15.0	8	F611BE185(1)100(2)
100	63	2.2	BG	6	12	18	15.0	8	F611BG225(1)100(2)
100	63	2.7	BK	7.5	13.5	18	15.0	8	F611BK275(1)100(2)
100	63	3.3	BK	7.5	13.5	18	15.0	8	F611BK335(1)100(2)
100	63	3.9	BP	8.5	14.5	18	15.0	8	F611BP395(1)100(2)
100	63	4.7	BP	8.5	14.5	18	15.0	8	F611BP475(1)100(2)
100	63	5.6	BS	10	16	18	15.0	8	F611BS565(1)100(2)
100	63	6.8	BY	11	19	18	15.0	8	F611BY685(1)100(2)
100	63	8.2	BY	11	19	18	15.0	8	F611BY825(1)100(2)
100	63	2.2	DB	6	14.5	26	22.5	5	F611DB225(1)100(2)
100	63	2.7	DB	6	14.5	26	22.5	5	F611DB275(1)100(2)
100	63	3.3	DB	6	14.5	26	22.5	5	F611DB335(1)100(2)
100	63	3.9	DB	6	14.5	26	22.5	5	F611DB395(1)100(2)
100	63	4.7	DI	7	16	26	22.5	5	F611DI475(1)100(2)
100	63	5.6	DI	7	16	26	22.5	5	F611DI565(1)100(2)
100	63	6.8	DH	8	16	26	22.5	5	F611DH685(1)100(2)
100	63	8.2	DJ	8.5	17	26	22.5	5	F611DJ825(1)100(2)
100	63	10	DM	9	18.5	26	22.5	5	F611DM106(1)100(2)
100	63	12	DO	10	18.5	26	22.5	5	F611DO126(1)100(2)
100	63	15	DP	11	20	26	22.5	5	F611DP156(1)100(2)
100	63	18	DU	13	22	26	22.5	5	F611DU186(1)100(2)
100	63	22	DY	15.5	24.5	26	22.5	5	F611DY226(1)100(2)
100	63	27	DY	15.5	24.5	26	22.5	5	F611DY276(1)100(2)
100	63	10	FB	9	17	31.5	27.5	3	F611FB106(1)100(2)
100	63	10	FB	9	17	31.5	27.5	3	F611FB126(1)100(2)
100	63	15	FC	11	20	31.5	27.5	3	F611FC156(1)100(2)
100	63	18	FC	11	20	31.5	27.5	3	F611FC186(1)100(2)
100	63	22	FI	13	25	31.5	27.5	3	F611FI226(1)100(2)
100	63	27	FI	13	25	31.5	27.5	3	F611FI276(1)100(2)
100	63	33	FN	14	28	31.5	27.5	3	F611FN336(1)100(2)
100	63	39	FR	17.5	28	31.5	27.5	3	F611FR396(1)100(2)
100	63	47	FS	19	29	31.5	27.5	3	F611FS476(1)100(2)
100	63	56	FY	22	37	31.5	27.5	3	F611FY566(1)100(2)
100	63	68	FY	22	37	31.5	27.5	3	F611FY686(1)100(2)
100	63	82	FY	22	37	31.5	27.5	3	F611FY826(1)100(2)
100	63	22	RB	11	22	41	37.5	2	F611RB226(1)100(2)
100	63	27	RB	11	22	41	37.5	2	F611RB276(1)100(2)
VDC	VAC	Capacitance Value (µF)	Size Code	B (mm)	H (mm)	L (mm)	Lead Spacing (p)	dV/dt (V/µs)	Part Number

(1) K = ±10%, M = ±20%, J = ±5% on request.

(2) Insert lead and packaging code. See table for available options.

Table 1 – Ratings & Part Number Reference cont'd

VDC	VAC	Capacitance Value (µF)	Size Code	Maximum Dimensions in mm			Lead Spacing (p)	dV/dt (V/µs)	Part Number
				B	H	L			
100	63	33	RF	13	24	41	37.5	2	F611RF336(1)100(2)
100	63	39	RH	15	26	41	37.5	2	F611RH396(1)100(2)
100	63	47	RH	15	26	41	37.5	2	F611RH476(1)100(2)
100	63	56	RC	16	28.5	41	37.5	2	F611RC566(1)100(2)
100	63	68	RD	19	32	41	37.5	2	F611RD686(1)100(2)
100	63	82	RP	21	38	41	37.5	2	F611RP826(1)100(2)
100	63	100	RP	21	38	41	37.5	2	F611RP107(1)100(2)
100	63	120	RO	24	44	41	37.5	2	F611RO127(1)100(2)
100	63	150	RO	24	44	41	37.5	2	F611RO157(1)100(2)
100	63	180	RU	30	45	41	37.5	2	F611RU187(1)100(2)
100	63	220	RU	30	45	41	37.5	2	F611RU227(1)100(2)
160	90	0.18	AG	4	9	13	10.0	100	F612AG184(1)160(2)
160	90	0.22	AG	4	9	13	10.0	100	F612AG224(1)160(2)
160	90	0.27	AG	4	9	13	10.0	100	F612AG274(1)160(2)
160	90	0.33	AG	4	9	13	10.0	100	F612AG334(1)160(2)
160	90	0.39	AK	5	11	13	10.0	100	F612AK394(1)160(2)
160	90	0.47	AK	5	11	13	10.0	100	F612AK474(1)160(2)
160	90	0.56	AK	5	11	13	10.0	100	F612AK564(1)160(2)
160	90	0.68	AP	6	12	13	10.0	100	F612AP684(1)160(2)
160	90	0.82	AP	6	12	13	10.0	100	F612AP824(1)160(2)
160	90	0.33	BB	4	10	18	15.0	10	F611BB334(1)160(2)
160	90	0.39	BB	4	10	18	15.0	10	F611BB394(1)160(2)
160	90	0.47	BC	5	11	18	15.0	10	F611BC474(1)160(2)
160	90	0.56	BC	5	11	18	15.0	10	F611BC564(1)160(2)
160	90	0.68	BC	5	11	18	15.0	10	F611BC684(1)160(2)
160	90	0.82	BE	5.5	12.5	18	15.0	10	F611BE824(1)160(2)
160	90	1	BG	6	12	18	15.0	10	F611BG105(1)160(2)
160	90	1.2	BK	7.5	13.5	18	15.0	10	F611BK125(1)160(2)
160	90	1.5	BK	7.5	13.5	18	15.0	10	F611BK155(1)160(2)
160	90	1.8	BP	8.5	14.5	18	15.0	10	F611BP185(1)160(2)
160	90	2.2	BS	10	16	18	15.0	10	F611BS225(1)160(2)
160	90	2.7	BY	11	19	18	15.0	10	F611BY275(1)160(2)
160	90	3.3	BY	11	19	18	15.0	10	F611BY335(1)160(2)
160	90	3.9	BY	11	19	18	15.0	10	F611BY395(1)160(2)
160	90	1.2	DB	6	14.5	26	22.5	6	F611DB125(1)160(2)
160	90	1.5	DB	6	14.5	26	22.5	6	F611DB155(1)160(2)
160	90	1.8	DB	6	14.5	26	22.5	6	F611DB185(1)160(2)
160	90	2.2	DI	7	16	26	22.5	6	F611DI225(1)160(2)
160	90	2.7	DI	7	16	26	22.5	6	F611DI275(1)160(2)
160	90	3.3	DJ	8.5	17	26	22.5	6	F611DJ335(1)160(2)
160	90	3.9	DM	9	18.5	26	22.5	6	F611DM395(1)160(2)
160	90	4.7	DO	10	18.5	26	22.5	6	F611DO475(1)160(2)
160	90	5.6	DP	11	20	26	22.5	6	F611DP565(1)160(2)
160	90	6.8	DU	13	22	26	22.5	6	F611DU685(1)160(2)
160	90	8.2	DU	13	22	26	22.5	6	F611DU825(1)160(2)
160	90	10	DY	15.5	24.5	26	22.5	6	F611DY106(1)160(2)
160	90	12	DY	15.5	24.5	26	22.5	6	F611DY126(1)160(2)
160	90	5.6	FB	9	17	31.5	27.5	4	F611FB565(1)160(2)
160	90	6.8	FB	9	17	31.5	27.5	4	F611FB685(1)160(2)
160	90	8.2	FB	9	17	31.5	27.5	4	F611FB825(1)160(2)
160	90	10	FC	11	20	31.5	27.5	4	F611FC106(1)160(2)
160	90	12	FC	11	20	31.5	27.5	4	F611FC126(1)160(2)
160	90	15	FI	13	25	31.5	27.5	4	F611FI156(1)160(2)
160	90	18	FI	13	25	31.5	27.5	4	F611FI186(1)160(2)
160	90	22	FN	14	28	31.5	27.5	4	F611FN226(1)160(2)
160	90	27	FR	17.5	28	31.5	27.5	4	F611FR276(1)160(2)
160	90	33	FS	19	29	31.5	27.5	4	F611FS336(1)160(2)
160	90	39	FY	22	37	31.5	27.5	4	F611FY396(1)160(2)
160	90	47	FY	22	37	31.5	27.5	4	F611FY476(1)160(2)
160	90	56	FY	22	37	31.5	27.5	4	F611FY566(1)160(2)
VDC	VAC	Capacitance Value (µF)	Size Code	B (mm)	H (mm)	L (mm)	Lead Spacing (p)	dV/dt (V/µs)	Part Number

(1) K= ±10%, M = ±20%, J = ±5% on request.

(2) Insert lead and packaging code. See table for available options.

Table 1 – Ratings & Part Number Reference cont'd

VDC	VAC	Capacitance Value (µF)	Size Code	Maximum Dimensions in mm			Lead Spacing (p)	dV/dt (V/µs)	Part Number
				B	H	L			
160	90	15	RB	11	22	41	37.5	3	F611RB156(1)160(2)
160	90	18	RB	11	22	41	37.5	3	F611RB186(1)160(2)
160	90	22	RF	13	24	41	37.5	3	F611RF226(1)160(2)
160	90	27	RH	15	26	41	37.5	3	F611RH276(1)160(2)
160	90	33	RH	15	26	41	37.5	3	F611RH336(1)160(2)
160	90	39	RC	16	28.5	41	37.5	3	F611RC396(1)160(2)
160	90	47	RD	19	32	41	37.5	3	F611RD476(1)160(2)
160	90	56	RP	21	38	41	37.5	3	F611RP566(1)160(2)
160	90	68	RP	21	38	41	37.5	3	F611RP686(1)160(2)
160	90	82	RO	24	44	41	37.5	3	F611RO826(1)160(2)
160	90	100	RO	24	44	41	37.5	3	F611RO107(1)160(2)
160	90	120	RU	30	45	41	37.5	3	F611RU127(1)160(2)
160	90	150	RU	30	45	41	37.5	3	F611RU157(1)160(2)
250	160	0.0068	JF	2.5	6.5	7.2	5.0	250	F612JF682(1)250(2)
250	160	0.0082	JF	2.5	6.5	7.2	5.0	250	F612JF822(1)250(2)
250	160	0.01	JF	2.5	6.5	7.2	5.0	250	F612JF103(1)250(2)
250	160	0.012	JF	2.5	6.5	7.2	5.0	250	F612JF123(1)250(2)
250	160	0.015	JF	2.5	6.5	7.2	5.0	250	F612JF153(1)250(2)
250	160	0.018	JF	2.5	6.5	7.2	5.0	250	F612JF183(1)250(2)
250	160	0.022	JG	3.5	7.5	7.2	5.0	250	F612JG223(1)250(2)
250	160	0.027	JG	3.5	7.5	7.2	5.0	250	F612JG273(1)250(2)
250	160	0.033	JG	3.5	7.5	7.2	5.0	250	F612JG333(1)250(2)
250	160	0.039	JG	3.5	7.5	7.2	5.0	250	F612JG393(1)250(2)
250	160	0.047	JM	4.5	9.5	7.2	5.0	250	F612JM473(1)250(2)
250	160	0.056	JM	4.5	9.5	7.2	5.0	250	F612JM563(1)250(2)
250	160	0.068	JM	4.5	9.5	7.2	5.0	250	F612JM683(1)250(2)
250	160	0.082	JQ	5	10	7.2	5.0	250	F612JQ823(1)250(2)
250	160	0.1	JQ	5	10	7.2	5.0	250	F612JQ104(1)250(2)
250	160	0.12	JT	6	11	7.2	5.0	250	F612JT124(1)250(2)
250	160	0.15	JT	6	11	7.2	5.0	250	F612JT154(1)250(2)
250	140	0.022	JF	2.5	6.5	7.2	5.0	130	F612JF223(1)250(2)
250	140	0.027	JF	2.5	6.5	7.2	5.0	130	F612JF273(1)250(2)
250	140	0.047	JG	3.5	7.5	7.2	5.0	130	F612JG473(1)250(2)
250	140	0.056	JG	3.5	7.5	7.2	5.0	130	F612JG563(1)250(2)
250	140	0.068	JG	3.5	7.5	7.2	5.0	130	F612JG683(1)250(2)
250	140	0.082	JM	4.5	9.5	7.2	5.0	130	F612JM823(1)250(2)
250	140	0.1	JM	4.5	9.5	7.2	5.0	130	F612JM104(1)250(2)
250	140	0.12	JM	4.5	9.5	7.2	5.0	130	F612JM124(1)250(2)
250	140	0.15	JQ	5	10	7.2	5.0	130	F612JQ154(1)250(2)
250	140	0.18	JT	6	11	7.2	5.0	130	F612JT184(1)250(2)
250	140	0.22	JT	6	11	7.2	5.0	130	F612JT224(1)250(2)
250	160	0.022	KF	3	8	10	7.5	200	F612KF223(1)250(2)
250	160	0.027	KF	3	8	10	7.5	200	F612KF273(1)250(2)
250	160	0.033	KF	3	8	10	7.5	200	F612KF333(1)250(2)
250	160	0.039	KF	3	8	10	7.5	200	F612KF393(1)250(2)
250	160	0.047	KF	3	8	10	7.5	200	F612KF473(1)250(2)
250	160	0.056	KF	3	8	10	7.5	200	F612KF563(1)250(2)
250	160	0.068	KF	3	8	10	7.5	200	F612KF683(1)250(2)
250	160	0.082	KH	4	9	10	7.5	200	F612KH823(1)250(2)
250	160	0.1	KH	4	9	10	7.5	200	F612KH104(1)250(2)
250	160	0.12	KH	4	9	10	7.5	200	F612KH124(1)250(2)
250	160	0.15	KH	4	9	10	7.5	200	F612KH154(1)250(2)
250	160	0.18	KJ	5	10.5	10	7.5	200	F612KJ184(1)250(2)
250	160	0.22	KJ	5	10.5	10	7.5	200	F612KJ224(1)250(2)
250	160	0.27	KM	6	12	10.5	7.5	200	F612KM274(1)250(2)
250	160	0.33	KM	6	12	10.5	7.5	200	F612KM334(1)250(2)
250	160	0.39	KM	6	12	10.5	7.5	200	F612KM394(1)250(2)
250	160	0.1	AG	4	9	13	10.0	20	F611AG104(1)250(2)
250	160	0.12	AG	4	9	13	10.0	20	F611AG124(1)250(2)
250	160	0.15	AG	4	9	13	10.0	20	F611AG154(1)250(2)
VDC	VAC	Capacitance Value (µF)	Size Code	B (mm)	H (mm)	L (mm)	Lead Spacing (p)	dV/dt (V/µs)	Part Number

(1) K = ±10%, M = ±20%, J = ±5% on request.

(2) Insert lead and packaging code. See table for available options.

Table 1 – Ratings & Part Number Reference cont'd

VDC	VAC	Capacitance Value (µF)	Size Code	Maximum Dimensions in mm			Lead Spacing (p)	dV/dt (V/µs)	Part Number
				B	H	L			
250	160	0.18	AK	5	11	13	10.0	20	F611AK184(1)250(2)
250	160	0.22	AK	5	11	13	10.0	20	F611AK224(1)250(2)
250	160	0.27	AK	5	11	13	10.0	20	F611AK274(1)250(2)
250	160	0.33	AP	6	12	13	10.0	20	F611AP334(1)250(2)
250	160	0.39	AP	6	12	13	10.0	20	F611AP394(1)250(2)
250	160	0.47	AP	6	12	13	10.0	20	F611AP474(1)250(2)
250	160	0.18	BB	4	10	18	15.0	12	F611BB184(1)250(2)
250	160	0.22	BB	4	10	18	15.0	12	F611BB224(1)250(2)
250	160	0.27	BB	4	10	18	15.0	12	F611BB274(1)250(2)
250	160	0.33	BC	5	11	18	15.0	12	F611BC334(1)250(2)
250	160	0.39	BC	5	11	18	15.0	12	F611BC394(1)250(2)
250	160	0.47	BE	5.5	12.5	18	15.0	12	F611BE474(1)250(2)
250	160	0.56	BG	6	12	18	15.0	12	F611BG564(1)250(2)
250	160	0.68	BK	7.5	13.5	18	15.0	12	F611BK684(1)250(2)
250	160	0.82	BK	7.5	13.5	18	15.0	12	F611BK824(1)250(2)
250	160	1	BK	7.5	13.5	18	15.0	12	F611BK105(1)250(2)
250	160	1.2	BP	8.5	14.5	18	15.0	12	F611BP125(1)250(2)
250	160	1.5	BS	10	16	18	15.0	12	F611BS155(1)250(2)
250	160	1.8	BY	11	19	18	15.0	12	F611BY185(1)250(2)
250	160	2.2	BY	11	19	18	15.0	12	F611BY225(1)250(2)
250	160	0.82	DB	6	14.5	26	22.5	8	F611DB824(1)250(2)
250	160	1	DB	6	14.5	26	22.5	8	F611DB105(1)250(2)
250	160	1.2	DI	7	16	26	22.5	8	F611DI125(1)250(2)
250	160	1.5	DI	7	16	26	22.5	8	F611DI155(1)250(2)
250	160	1.8	DH	8	16	26	22.5	8	F611DH185(1)250(2)
250	160	2.2	DJ	8.5	17	26	22.5	8	F611DJ225(1)250(2)
250	160	2.7	DO	10	18.5	26	22.5	8	F611DO275(1)250(2)
250	160	3.3	DP	11	20	26	22.5	8	F611DP335(1)250(2)
250	160	3.9	DU	13	22	26	22.5	8	F611DU395(1)250(2)
250	160	4.7	DU	13	22	26	22.5	8	F611DU475(1)250(2)
250	160	5.6	DY	15.5	24.5	26	22.5	8	F611DY565(1)250(2)
250	160	6.8	DY	15.5	24.5	26	22.5	8	F611DY685(1)250(2)
250	160	2.2	FB	9	17	31.5	27.5	5	F611FB225(1)250(2)
250	160	2.7	FB	9	17	31.5	27.5	5	F611FB275(1)250(2)
250	160	3.3	FB	9	17	31.5	27.5	5	F611FB335(1)250(2)
250	160	3.9	FB	9	17	31.5	27.5	5	F611FB395(1)250(2)
250	160	4.7	FB	9	17	31.5	27.5	5	F611FB475(1)250(2)
250	160	5.6	FC	11	20	31.5	27.5	5	F611FC565(1)250(2)
250	160	6.8	FC	11	20	31.5	27.5	5	F611FC685(1)250(2)
250	160	8.2	FI	13	25	31.5	27.5	5	F611FI825(1)250(2)
250	160	10	FI	13	25	31.5	27.5	5	F611FI106(1)250(2)
250	160	12	FI	13	25	31.5	27.5	5	F611FI126(1)250(2)
250	160	15	FN	14	28	31.5	27.5	5	F611FN156(1)250(2)
250	160	18	FR	17.5	28	31.5	27.5	5	F611FR186(1)250(2)
250	160	22	FS	19	29	31.5	27.5	5	F611FS226(1)250(2)
250	160	27	FY	22	37	31.5	27.5	5	F611FY276(1)250(2)
250	160	33	FY	22	37	31.5	27.5	5	F611FY336(1)250(2)
250	160	39	FY	22	37	31.5	27.5	5	F611FY396(1)250(2)
250	160	5.6	RB	11	22	41	37.5	4	F611RB565(1)250(2)
250	160	6.8	RB	11	22	41	37.5	4	F611RB685(1)250(2)
250	160	8.2	RB	11	22	41	37.5	4	F611RB825(1)250(2)
250	160	10	RB	11	22	41	37.5	4	F611RB106(1)250(2)
250	160	12	RB	11	22	41	37.5	4	F611RB126(1)250(2)
250	160	15	RF	13	24	41	37.5	4	F611RF156(1)250(2)
250	160	18	RH	15	26	41	37.5	4	F611RH186(1)250(2)
250	160	22	RH	15	26	41	37.5	4	F611RH226(1)250(2)
250	160	27	RC	16	28.5	41	37.5	4	F611RC276(1)250(2)
250	160	33	RD	19	32	41	37.5	4	F611RD336(1)250(2)
250	160	39	RP	21	38	41	37.5	4	F611RP396(1)250(2)
250	160	47	RP	21	38	41	37.5	4	F611RP476(1)250(2)
VDC	VAC	Capacitance Value (µF)	Size Code	B (mm)	H (mm)	L (mm)	Lead Spacing (p)	dV/dt (V/µs)	Part Number

(1) K = ±10%, M = ±20%, J = ±5% on request.

(2) Insert lead and packaging code. See table for available options.

Table 1 – Ratings & Part Number Reference cont'd

VDC	VAC	Capacitance Value (µF)	Size Code	Maximum Dimensions in mm			Lead Spacing (p)	dV/dt (V/µs)	Part Number
				B	H	L			
250	160	56	RO	24	44	41	37.5	4	F611RO566(1)250(2)
250	160	68	RO	24	44	41	37.5	4	F611RO686(1)250(2)
250	160	82	RU	30	45	41	37.5	4	F611RU826(1)250(2)
400	200	0.001	JF	2.5	6.5	7.2	5.0	400	F612JF102(1)400(2)
400	200	0.0012	JF	2.5	6.5	7.2	5.0	400	F612JF122(1)400(2)
400	200	0.0015	JF	2.5	6.5	7.2	5.0	400	F612JF152(1)400(2)
400	200	0.0018	JF	2.5	6.5	7.2	5.0	400	F612JF182(1)400(2)
400	200	0.0022	JF	2.5	6.5	7.2	5.0	400	F612JF222(1)400(2)
400	200	0.0027	JF	2.5	6.5	7.2	5.0	400	F612JF272(1)400(2)
400	200	0.0033	JF	2.5	6.5	7.2	5.0	400	F612JF332(1)400(2)
400	200	0.0039	JF	2.5	6.5	7.2	5.0	400	F612JF392(1)400(2)
400	200	0.0047	JF	2.5	6.5	7.2	5.0	400	F612JF472(1)400(2)
400	200	0.0056	JG	3.5	7.5	7.2	5.0	400	F612JG562(1)400(2)
400	200	0.0068	JG	3.5	7.5	7.2	5.0	400	F612JG682(1)400(2)
400	200	0.082	JG	3.5	7.5	7.2	5.0	400	F612JG823(1)400(2)
400	200	0.01	JG	3.5	7.5	7.2	5.0	400	F612JG103(1)400(2)
400	200	0.012	JG	3.5	7.5	7.2	5.0	400	F612JG123(1)400(2)
400	200	0.015	JM	4.5	9.5	7.2	5.0	400	F612JM153(1)400(2)
400	200	0.018	JM	4.5	9.5	7.2	5.0	400	F612JM183(1)400(2)
400	200	0.022	JM	4.5	9.5	7.2	5.0	400	F612JM223(1)400(2)
400	200	0.027	JQ	5	10	7.2	5.0	400	F612JQ273(1)400(2)
400	200	0.033	JQ	5	10	7.2	5.0	400	F612JQ333(1)400(2)
400	200	0.039	JT	6	11	7.2	5.0	400	F612JT393(1)400(2)
400	200	0.047	JT	6	11	7.2	5.0	400	F612JT473(1)400(2)
400	200	0.056	JT	6	11	7.2	5.0	400	F612JT563(1)400(2)
400	160	0.0068	JF	2.5	6.5	7.2	5.0	200	F612JF682(1)400(2)
400	160	0.0082	JF	2.5	6.5	7.2	5.0	200	F612JF822(1)400(2)
400	160	0.015	JG	3.5	7.5	7.2	5.0	200	F612JG153(1)400(2)
400	160	0.018	JG	3.5	7.5	7.2	5.0	200	F612JG183(1)400(2)
400	160	0.033	JM	4.5	9.5	7.2	5.0	200	F612JM333(1)400(2)
400	160	0.039	JM	4.5	9.5	7.2	5.0	200	F612JM393(1)400(2)
400	160	0.047	JQ	5	10	7.2	5.0	200	F612JQ473(1)400(2)
400	160	0.068	JT	6	11	7.2	5.0	200	F612JT683(1)400(2)
400	200	0.0068	KF	3	8	10	7.5	275	F612KF682(1)400(2)
400	200	0.0082	KF	3	8	10	7.5	275	F612KF822(1)400(2)
400	200	0.01	KF	3	8	10	7.5	275	F612KF103(1)400(2)
400	200	0.012	KF	3	8	10	7.5	275	F612KF123(1)400(2)
400	200	0.015	KF	3	8	10	7.5	275	F612KF153(1)400(2)
400	200	0.018	KF	3	8	10	7.5	275	F612KF183(1)400(2)
400	200	0.022	KF	3	8	10	7.5	275	F612KF223(1)400(2)
400	200	0.027	KF	3	8	10	7.5	275	F612KF273(1)400(2)
400	200	0.033	KH	4	9	10	7.5	275	F612KH333(1)400(2)
400	200	0.039	KH	4	9	10	7.5	275	F612KH393(1)400(2)
400	200	0.047	KH	4	9	10	7.5	275	F612KH473(1)400(2)
400	200	0.056	KH	4	9	10	7.5	275	F612KH563(1)400(2)
400	200	0.068	KJ	5	10.5	10	7.5	275	F612KJ683(1)400(2)
400	200	0.082	KJ	5	10.5	10	7.5	275	F612KJ823(1)400(2)
400	200	0.1	KM	6	12	10.5	7.5	275	F612KM104(1)400(2)
400	200	0.12	KM	6	12	10.5	7.5	275	F612KM124(1)400(2)
400	200	0.15	KM	6	12	10.5	7.5	275	F612KM154(1)400(2)
400	200	0.033	AG	4	9	13	10.0	30	F611AG333(1)400(2)
400	200	0.039	AG	4	9	13	10.0	30	F611AG393(1)400(2)
400	200	0.047	AG	4	9	13	10.0	30	F611AG473(1)400(2)
400	200	0.056	AG	4	9	13	10.0	30	F611AG563(1)400(2)
400	200	0.068	AG	4	9	13	10.0	30	F611AG683(1)400(2)
400	200	0.082	AG	4	9	13	10.0	30	F611AG823(1)400(2)
400	200	0.1	AK	5	11	13	10.0	30	F611AK104(1)400(2)
400	200	0.12	AK	5	11	13	10.0	30	F611AK124(1)400(2)
400	200	0.15	AK	5	11	13	10.0	30	F611AK154(1)400(2)
400	200	0.18	AP	6	12	13	10.0	30	F611AP184(1)400(2)
VDC	VAC	Capacitance Value (µF)	Size Code	B (mm)	H (mm)	L (mm)	Lead Spacing (p)	dV/dt (V/µs)	Part Number

(1) K = ±10%, M = ±20%, J = ±5% on request.

(2) Insert lead and packaging code. See table for available options.

Table 1 – Ratings & Part Number Reference cont'd

VDC	VAC	Capacitance Value (µF)	Size Code	Maximum Dimensions in mm			Lead Spacing (p)	dV/dt (V/µs)	Part Number
				B	H	L			
400	200	0.22	AP	6	12	13	10.0	30	F611AP224(1)400(2)
400	200	0.056	BB	4	10	18	15.0	20	F611BB563(1)400(2)
400	200	0.068	BB	4	10	18	15.0	20	F611BB683(1)400(2)
400	200	0.082	BB	4	10	18	15.0	20	F611BB823(1)400(2)
400	200	0.1	BB	4	10	18	15.0	20	F611BB104(1)400(2)
400	200	0.12	BB	4	10	18	15.0	20	F611BB124(1)400(2)
400	200	0.15	BB	4	10	18	15.0	20	F611BB154(1)400(2)
400	200	0.18	BC	5	11	18	15.0	20	F611BC184(1)400(2)
400	200	0.22	BC	5	11	18	15.0	20	F611BC224(1)400(2)
400	200	0.27	BE	5.5	12.5	18	15.0	20	F611BE274(1)400(2)
400	200	0.33	BG	6	12	18	15.0	20	F611BG334(1)400(2)
400	200	0.39	BK	7.5	13.5	18	15.0	20	F611BK394(1)400(2)
400	200	0.47	BK	7.5	13.5	18	15.0	20	F611BK474(1)400(2)
400	200	0.56	BK	7.5	13.5	18	15.0	20	F611BK564(1)400(2)
400	200	0.68	BP	8.5	14.5	18	15.0	20	F611BP684(1)400(2)
400	200	0.82	BS	10	16	18	15.0	20	F611BS824(1)400(2)
400	200	1	BY	11	19	18	15.0	20	F611BY105(1)400(2)
400	200	1.2	BY	11	19	18	15.0	20	F611BY125(1)400(2)
400	200	1.5	BY	11	19	18	15.0	20	F611BY155(1)400(2)
400	200	0.27	DB	6	14.5	26	22.5	10	F611DB274(1)400(2)
400	200	0.33	DB	6	14.5	26	22.5	10	F611DB334(1)400(2)
400	200	0.39	DB	6	14.5	26	22.5	10	F611DB394(1)400(2)
400	200	0.47	DB	6	14.5	26	22.5	10	F611DB474(1)400(2)
400	200	0.56	DB	6	14.5	26	22.5	10	F611DB564(1)400(2)
400	200	0.68	DB	6	14.5	26	22.5	10	F611DB684(1)400(2)
400	200	0.82	DI	7	16	26	22.5	10	F611DI824(1)400(2)
400	200	1	DI	7	16	26	22.5	10	F611DI105(1)400(2)
400	200	1.2	DJ	8.5	17	26	22.5	10	F611DJ125(1)400(2)
400	200	1.5	DM	9	18.5	26	22.5	10	F611DM155(1)400(2)
400	200	1.8	DO	10	18.5	26	22.5	10	F611DO185(1)400(2)
400	200	2.2	DP	11	20	26	22.5	10	F611DP225(1)400(2)
400	200	2.7	DU	13	22	26	22.5	10	F611DU275(1)400(2)
400	200	3.3	DU	13	22	26	22.5	10	F611DU335(1)400(2)
400	200	3.9	DY	15.5	24.5	26	22.5	10	F611DY395(1)400(2)
400	200	4.7	DY	15.5	24.5	26	22.5	10	F611DY475(1)400(2)
400	200	0.82	FB	9	17	31.5	27.5	8.5	F611FB824(1)400(2)
400	200	1	FB	9	17	31.5	27.5	8.5	F611FB105(1)400(2)
400	200	1.2	FB	9	17	31.5	27.5	8.5	F611FB125(1)400(2)
400	200	1.5	FB	9	17	31.5	27.5	8.5	F611FB155(1)400(2)
400	200	1.8	FB	9	17	31.5	27.5	8.5	F611FB185(1)400(2)
400	200	2.2	FC	11	20	31.5	27.5	8.5	F611FC225(1)400(2)
400	200	2.7	FC	11	20	31.5	27.5	8.5	F611FC275(1)400(2)
400	200	3.3	FI	13	25	31.5	27.5	8.5	F611FI335(1)400(2)
400	200	3.9	FI	13	25	31.5	27.5	8.5	F611FI395(1)400(2)
400	200	4.7	FI	13	25	31.5	27.5	8.5	F611FI475(1)400(2)
400	200	5.6	FN	14	28	31.5	27.5	8.5	F611FN565(1)400(2)
400	200	6.8	FR	17.5	28	31.5	27.5	8.5	F611FR685(1)400(2)
400	200	8.2	FR	17.5	28	31.5	27.5	8.5	F611FR825(1)400(2)
400	200	10	FS	19	29	31.5	27.5	8.5	F611FS106(1)400(2)
400	200	12	FY	22	37	31.5	27.5	8.5	F611FY126(1)400(2)
400	200	15	FY	22	37	31.5	27.5	8.5	F611FY156(1)400(2)
400	200	2.2	RB	11	22	41	37.5	6	F611RB225(1)400(2)
400	200	2.7	RB	11	22	41	37.5	6	F611RB275(1)400(2)
400	200	3.3	RB	11	22	41	37.5	6	F611RB335(1)400(2)
400	200	3.9	RB	11	22	41	37.5	6	F611RB395(1)400(2)
400	200	4.7	RB	11	22	41	37.5	6	F611RB475(1)400(2)
400	200	5.6	RF	13	24	41	37.5	6	F611RF565(1)400(2)
400	200	6.8	RF	13	24	41	37.5	6	F611RF685(1)400(2)
400	200	8.2	RH	15	26	41	37.5	6	F611RH825(1)400(2)
400	200	10	RC	16	28.5	41	37.5	6	F611RC106(1)400(2)
VDC	VAC	Capacitance Value (µF)	Size Code	B (mm)	H (mm)	L (mm)	Lead Spacing (p)	dV/dt (V/µs)	Part Number

(1) K = ±10%, M = ±20%, J = ±5% on request.

(2) Insert lead and packaging code. See table for available options.

Table 1 – Ratings & Part Number Reference cont'd

VDC	VAC	Capacitance Value (µF)	Size Code	Maximum Dimensions in mm			Lead Spacing (p)	dV/dt (V/µs)	Part Number
				B	H	L			
400	200	12	RD	19	32	41	37.5	6	F611RD126(1)400(2)
400	200	15	RP	21	38	41	37.5	6	F611RP156(1)400(2)
400	200	18	RP	21	38	41	37.5	6	F611RP186(1)400(2)
400	200	22	RO	24	44	41	37.5	6	F611RO226(1)400(2)
400	200	27	RO	24	44	41	37.5	6	F611RO276(1)400(2)
400	200	33	RU	30	45	41	37.5	6	F611RU336(1)400(2)
630	220	0.0012	JF	2.5	6.5	7.2	5.0	80	F611JF122(1)630(2)
630	220	0.0015	JF	2.5	6.5	7.2	5.0	80	F611JF152(1)630(2)
630	220	0.0018	JF	2.5	6.5	7.2	5.0	80	F611JF182(1)630(2)
630	220	0.0022	JF	2.5	6.5	7.2	5.0	80	F611JF222(1)630(2)
630	220	0.0027	JF	2.5	6.5	7.2	5.0	80	F611JF272(1)630(2)
630	220	0.0033	JF	2.5	6.5	7.2	5.0	80	F611JF332(1)630(2)
630	220	0.0039	JF	2.5	6.5	7.2	5.0	80	F611JF392(1)630(2)
630	220	0.0047	JG	3.5	7.5	7.2	5.0	80	F611JG472(1)630(2)
630	220	0.0056	JG	3.5	7.5	7.2	5.0	80	F611JG562(1)630(2)
630	220	0.0068	JG	3.5	7.5	7.2	5.0	80	F611JG682(1)630(2)
630	220	0.0082	JG	3.5	7.5	7.2	5.0	80	F611JG822(1)630(2)
630	220	0.01	JG	3.5	7.5	7.2	5.0	80	F611JG103(1)630(2)
630	220	0.012	JM	4.5	9.5	7.2	5.0	80	F611JM123(1)630(2)
630	220	0.015	JM	4.5	9.5	7.2	5.0	80	F611JM153(1)630(2)
630	220	0.018	JM	4.5	9.5	7.2	5.0	80	F611JM183(1)630(2)
630	220	0.022	JQ	5	10	7.2	5.0	80	F611JQ223(1)630(2)
630	220	0.027	JT	6	11	7.2	5.0	80	F611JT273(1)630(2)
630	220	0.033	JT	6	11	7.2	5.0	80	F611JT333(1)630(2)
630	220	0.039	JU	7.2	13	7.2	5.0	80	F611JU393(1)630(2)
630	220	0.047	JU	7.2	13	7.2	5.0	80	F611JU473(1)630(2)
630	220	0.0018	KE	2.5	6	10	7.5	60	F611KE182(1)630(2)
630	220	0.0022	KE	2.5	6	10	7.5	60	F611KE222(1)630(2)
630	220	0.0027	KE	2.5	6	10	7.5	60	F611KE272(1)630(2)
630	220	0.0033	KE	2.5	6	10	7.5	60	F611KE332(1)630(2)
630	220	0.0039	KE	2.5	6	10	7.5	60	F611KE392(1)630(2)
630	220	0.0047	KE	2.5	6	10	7.5	60	F611KE472(1)630(2)
630	220	0.0056	KF	3	8	10	7.5	60	F611KF562(1)630(2)
630	220	0.0068	KF	3	8	10	7.5	60	F611KF682(1)630(2)
630	220	0.0082	KF	3	8	10	7.5	60	F611KF822(1)630(2)
630	220	0.01	KF	3	8	10	7.5	60	F611KF103(1)630(2)
630	220	0.012	KG	4	8	10	7.5	60	F611KG123(1)630(2)
630	220	0.015	KG	4	8	10	7.5	60	F611KG153(1)630(2)
630	220	0.018	KG	4	8	10	7.5	60	F611KG183(1)630(2)
630	220	0.022	KJ	5	10.5	10	7.5	60	F611KJ223(1)630(2)
630	220	0.027	KJ	5	10.5	10	7.5	60	F611KJ273(1)630(2)
630	220	0.033	KJ	5	10.5	10	7.5	60	F611KJ333(1)630(2)
630	220	0.039	KJ	5	10.5	10	7.5	60	F611KJ393(1)630(2)
630	220	0.047	KM	6	12	10.5	7.5	60	F611KM473(1)630(2)
630	220	0.056	KM	6	12	10.5	7.5	60	F611KM563(1)630(2)
630	220	0.068	KM	6	12	10.5	7.5	60	F611KM683(1)630(2)
630	220	0.012	AG	4	9	13	10.0	40	F611AG123(1)630(2)
630	220	0.015	AG	4	9	13	10.0	40	F611AG153(1)630(2)
630	220	0.018	AG	4	9	13	10.0	40	F611AG183(1)630(2)
630	220	0.022	AG	4	9	13	10.0	40	F611AG223(1)630(2)
630	220	0.027	AG	4	9	13	10.0	40	F611AG273(1)630(2)
630	220	0.033	AK	5	11	13	10.0	40	F611AK333(1)630(2)
630	220	0.039	AK	5	11	13	10.0	40	F611AK393(1)630(2)
630	220	0.047	AK	5	11	13	10.0	40	F611AK473(1)630(2)
630	220	0.056	AP	6	12	13	10.0	40	F611AP563(1)630(2)
630	220	0.068	AP	6	12	13	10.0	40	F611AP683(1)630(2)
630	220	0.082	AP	6	12	13	10.0	40	F611AP823(1)630(2)
630	220	0.022	BB	4	10	18	15.0	25	F611BB223(1)630(2)
630	220	0.027	BB	4	10	18	15.0	25	F611BB273(1)630(2)
630	220	0.033	BB	4	10	18	15.0	25	F611BB333(1)630(2)
VDC	VAC	Capacitance Value (µF)	Size Code	B (mm)	H (mm)	L (mm)	Lead Spacing (p)	dV/dt (V/µs)	Part Number

(1) K = ±10%, M = ±20%, J = ±5% on request.

(2) Insert lead and packaging code. See table for available options.

Table 1 – Ratings & Part Number Reference cont'd

VDC	VAC	Capacitance Value (µF)	Size Code	Maximum Dimensions in mm			Lead Spacing (p)	dV/dt (V/µs)	Part Number
				B	H	L			
630	220	0.039	BB	4	10	18	15.0	25	F611BB393(1)630(2)
630	220	0.047	BB	4	10	18	15.0	25	F611BB473(1)630(2)
630	220	0.056	BC	5	11	18	15.0	25	F611BC563(1)630(2)
630	220	0.068	BC	5	11	18	15.0	25	F611BC683(1)630(2)
630	220	0.082	BC	5	11	18	15.0	25	F611BC823(1)630(2)
630	220	0.1	BE	5.5	12.5	18	15.0	25	F611BE104(1)630(2)
630	220	0.12	BG	6	12	18	15.0	25	F611BG124(1)630(2)
630	220	0.15	BK	7.5	13.5	18	15.0	25	F611BK154(1)630(2)
630	220	0.18	BK	7.5	13.5	18	15.0	25	F611BK184(1)630(2)
630	220	0.22	BP	8.5	14.5	18	15.0	25	F611BP224(1)630(2)
630	220	0.27	BS	10	16	18	15.0	25	F611BS274(1)630(2)
630	220	0.33	BS	10	16	18	15.0	25	F611BS334(1)630(2)
630	220	0.39	BY	11	19	18	15.0	25	F611BY394(1)630(2)
630	220	0.47	BY	11	19	18	15.0	25	F611BY474(1)630(2)
630	220	0.12	DB	6	14.5	26	22.5	12	F611DB124(1)630(2)
630	220	0.15	DB	6	14.5	26	22.5	12	F611DB154(1)630(2)
630	220	0.18	DB	6	14.5	26	22.5	12	F611DB184(1)630(2)
630	220	0.22	DB	6	14.5	26	22.5	12	F611DB224(1)630(2)
630	220	0.27	DI	7	16	26	22.5	12	F611DI274(1)630(2)
630	220	0.33	DI	7	16	26	22.5	12	F611DI334(1)630(2)
630	220	0.39	DH	8	16	26	22.5	12	F611DH394(1)630(2)
630	220	0.47	DJ	8.5	17	26	22.5	12	F611DJ474(1)630(2)
630	220	0.56	DM	9	18.5	26	22.5	12	F611DM564(1)630(2)
630	220	0.68	DO	10	18.5	26	22.5	12	F611DO684(1)630(2)
630	220	0.82	DP	11	20	26	22.5	12	F611DP824(1)630(2)
630	220	1	DU	13	22	26	22.5	12	F611DU105(1)630(2)
630	220	1.2	DY	15.5	24.5	26	22.5	12	F611DY125(1)630(2)
630	220	1.5	DY	15.5	24.5	26	22.5	12	F611DY155(1)630(2)
630	220	0.33	FB	9	17	31.5	27.5	10	F611FB334(1)630(2)
630	220	0.39	FB	9	17	31.5	27.5	10	F611FB394(1)630(2)
630	220	0.47	FB	9	17	31.5	27.5	10	F611FB474(1)630(2)
630	220	0.56	FB	9	17	31.5	27.5	10	F611FB564(1)630(2)
630	220	0.68	FB	9	17	31.5	27.5	10	F611FB684(1)630(2)
630	220	0.82	FC	11	20	31.5	27.5	10	F611FC824(1)630(2)
630	220	1	FC	11	20	31.5	27.5	10	F611FC105(1)630(2)
630	220	1.2	FI	13	25	31.5	27.5	10	F611FI125(1)630(2)
630	220	1.5	FI	13	25	31.5	27.5	10	F611FI155(1)630(2)
630	220	1.8	FI	13	25	31.5	27.5	10	F611FI185(1)630(2)
630	220	2.2	FN	14	28	31.5	27.5	10	F611FN225(1)630(2)
630	220	2.7	FR	17.5	28	31.5	27.5	10	F611FR275(1)630(2)
630	220	3.3	FS	19	29	31.5	27.5	10	F611FS335(1)630(2)
630	220	3.9	FY	22	37	31.5	27.5	10	F611FY395(1)630(2)
630	220	4.7	FY	22	37	31.5	27.5	10	F611FY475(1)630(2)
630	220	0.82	RB	11	22	41	37.5	8	F611RB824(1)630(2)
630	220	1	RB	11	22	41	37.5	8	F611RB105(1)630(2)
630	220	1.2	RB	11	22	41	37.5	8	F611RB125(1)630(2)
630	220	1.5	RB	11	22	41	37.5	8	F611RB155(1)630(2)
630	220	1.8	RB	11	22	41	37.5	8	F611RB185(1)630(2)
630	220	2.2	RF	13	24	41	37.5	8	F611RF225(1)630(2)
630	220	2.7	RH	15	26	41	37.5	8	F611RH275(1)630(2)
630	220	3.3	RC	16	28.5	41	37.5	8	F611RC335(1)630(2)
630	220	3.9	RD	19	32	41	37.5	8	F611RD395(1)630(2)
630	220	4.7	RD	19	32	41	37.5	8	F611RD475(1)630(2)
630	220	5.6	RP	21	38	41	37.5	8	F611RP565(1)630(2)
630	220	6.8	RP	21	38	41	37.5	8	F611RP685(1)630(2)
630	220	8.2	RO	24	44	41	37.5	8	F611RO825(1)630(2)
630	220	10	RO	24	44	41	37.5	8	F611RO106(1)630(2)
630	220	12	RU	30	45	41	37.5	8	F611RU126(1)630(2)
1000	250	0.001	JF	2.5	6.5	7.2	5.0	100	F611JF102(1)1K0(2)
1000	250	0.0012	JG	3.5	7.5	7.2	5.0	100	F611JG122(1)1K0(2)

(1) K = ±10%, M = ±20%, J = ±5% on request.

(2) Insert lead and packaging code. See table for available options.

Table 1 – Ratings & Part Number Reference cont'd

VDC	VAC	Capacitance Value (µF)	Size Code	Maximum Dimensions in mm			Lead Spacing (p)	dV/dt (V/µs)	Part Number
				B	H	L			
1000	250	0.0015	JG	3.5	7.5	7.2	5.0	100	F611JG152(1)1K0(2)
1000	250	0.0018	JG	3.5	7.5	7.2	5.0	100	F611JG182(1)1K0(2)
1000	250	0.0022	JG	3.5	7.5	7.2	5.0	100	F611JG222(1)1K0(2)
1000	250	0.0027	JG	3.5	7.5	7.2	5.0	100	F611JG272(1)1K0(2)
1000	250	0.0033	JG	3.5	7.5	7.2	5.0	100	F611JG332(1)1K0(2)
1000	250	0.0039	JM	4.5	9.5	7.2	5.0	100	F611JM392(1)1K0(2)
1000	250	0.0047	JM	4.5	9.5	7.2	5.0	100	F611JM472(1)1K0(2)
1000	250	0.0056	JM	4.5	9.5	7.2	5.0	100	F611JM562(1)1K0(2)
1000	250	0.0068	JQ	5	10	7.2	5.0	100	F611JQ682(1)1K0(2)
1000	250	0.0082	JT	6	11	7.2	5.0	100	F611JT822(1)1K0(2)
1000	250	0.01	JT	6	11	7.2	5.0	100	F611JT103(1)1K0(2)
1000	250	0.012	JT	6	11	7.2	5.0	100	F611JT123(1)1K0(2)
1000	250	0.015	JU	7.2	13	7.2	5.0	100	F611JU153(1)1K0(2)
1000	250	0.018	JU	7.2	13	7.2	5.0	100	F611JU183(1)1K0(2)
1000	250	0.001	KE	2.5	6	10	7.5	80	F611KE102(1)1K0(2)
1000	250	0.0012	KE	2.5	6	10	7.5	80	F611KE122(1)1K0(2)
1000	250	0.0015	KE	2.5	6	10	7.5	80	F611KE152(1)1K0(2)
1000	250	0.0018	KF	3	8	10	7.5	80	F611KF182(1)1K0(2)
1000	250	0.0022	KF	3	8	10	7.5	80	F611KF222(1)1K0(2)
1000	250	0.0027	KF	3	8	10	7.5	80	F611KF272(1)1K0(2)
1000	250	0.0033	KF	3	8	10	7.5	80	F611KF332(1)1K0(2)
1000	250	0.0039	KG	4	8	10	7.5	80	F611KG392(1)1K0(2)
1000	250	0.0047	KG	4	8	10	7.5	80	F611KG472(1)1K0(2)
1000	250	0.0056	KG	4	8	10	7.5	80	F611KG562(1)1K0(2)
1000	250	0.0068	KG	4	8	10	7.5	80	F611KG682(1)1K0(2)
1000	250	0.0082	KJ	5	10.5	10	7.5	80	F611KJ822(1)1K0(2)
1000	250	0.01	KJ	5	10.5	10	7.5	80	F611KJ103(1)1K0(2)
1000	250	0.012	KJ	5	10.5	10	7.5	80	F611KJ123(1)1K0(2)
1000	250	0.015	KM	6	12	10.5	7.5	80	F611KM153(1)1K0(2)
1000	250	0.018	KM	6	12	10.5	7.5	80	F611KM183(1)1K0(2)
1000	250	0.022	KM	6	12	10.5	7.5	80	F611KM223(1)1K0(2)
1000	250	0.001	AG	4	9	13	10.0	60	F611AG102(1)1K0(2)
1000	250	0.0012	AG	4	9	13	10.0	60	F611AG122(1)1K0(2)
1000	250	0.0015	AG	4	9	13	10.0	60	F611AG152(1)1K0(2)
1000	250	0.0018	AG	4	9	13	10.0	60	F611AG182(1)1K0(2)
1000	250	0.0022	AG	4	9	13	10.0	60	F611AG222(1)1K0(2)
1000	250	0.0027	AG	4	9	13	10.0	60	F611AG272(1)1K0(2)
1000	250	0.0033	AG	4	9	13	10.0	60	F611AG332(1)1K0(2)
1000	250	0.0039	AG	4	9	13	10.0	60	F611AG392(1)1K0(2)
1000	250	0.0047	AG	4	9	13	10.0	60	F611AG472(1)1K0(2)
1000	250	0.0056	AG	4	9	13	10.0	60	F611AG562(1)1K0(2)
1000	250	0.0068	AG	4	9	13	10.0	60	F611AG682(1)1K0(2)
1000	250	0.0082	AG	4	9	13	10.0	60	F611AG822(1)1K0(2)
1000	250	0.01	AG	4	9	13	10.0	60	F611AG103(1)1K0(2)
1000	250	0.012	AG	4	9	13	10.0	60	F611AG123(1)1K0(2)
1000	250	0.015	AK	5	11	13	10.0	60	F611AK153(1)1K0(2)
1000	250	0.018	AK	5	11	13	10.0	60	F611AK183(1)1K0(2)
1000	250	0.022	AP	6	12	13	10.0	60	F611AP223(1)1K0(2)
1000	250	0.027	AP	6	12	13	10.0	60	F611AP273(1)1K0(2)
1000	250	0.033	AP	6	12	13	10.0	60	F611AP333(1)1K0(2)
1000	250	0.0082	BB	4	10	18	15.0	30	F611BB822(1)1K0(2)
1000	250	0.01	BB	4	10	18	15.0	30	F611BB103(1)1K0(2)
1000	250	0.012	BB	4	10	18	15.0	30	F611BB123(1)1K0(2)
1000	250	0.015	BB	4	10	18	15.0	30	F611BB153(1)1K0(2)
1000	250	0.018	BB	4	10	18	15.0	30	F611BB183(1)1K0(2)
1000	250	0.022	BC	5	11	18	15.0	30	F611BC223(1)1K0(2)
1000	250	0.027	BC	5	11	18	15.0	30	F611BC273(1)1K0(2)
1000	250	0.033	BC	5	11	18	15.0	30	F611BC333(1)1K0(2)
1000	250	0.039	BE	5.5	12.5	18	15.0	30	F611BE393(1)1K0(2)
1000	250	0.047	BG	6	12	18	15.0	30	F611BG473(1)1K0(2)
VDC	VAC	Capacitance Value (µF)	Size Code	B (mm)	H (mm)	L (mm)	Lead Spacing (p)	dV/dt (V/µs)	Part Number

(1) K = ±10%, M = ±20%, J = ±5% on request.

(2) Insert lead and packaging code. See table for available options.

Table 1 – Ratings & Part Number Reference cont'd

VDC	VAC	Capacitance Value (µF)	Size Code	Maximum Dimensions in mm			Lead Spacing (p)	dV/dt (V/µs)	Part Number
				B	H	L			
1000	250	0.056	BK	7.5	13.5	18	15.0	30	F611BK563(1)1K0(2)
1000	250	0.068	BK	7.5	13.5	18	15.0	30	F611BK683(1)1K0(2)
1000	250	0.082	BP	8.5	14.5	18	15.0	30	F611BP823(1)1K0(2)
1000	250	0.1	BP	8.5	14.5	18	15.0	30	F611BP104(1)1K0(2)
1000	250	0.12	BS	10	16	18	15.0	30	F611BS124(1)1K0(2)
1000	250	0.15	BY	11	19	18	15.0	30	F611BY154(1)1K0(2)
1000	250	0.18	BY	11	19	18	15.0	30	F611BY184(1)1K0(2)
1000	250	0.033	DB	6	14.5	26	22.5	15	F611DB333(1)1K0(2)
1000	250	0.039	DB	6	14.5	26	22.5	15	F611DB393(1)1K0(2)
1000	250	0.047	DB	6	14.5	26	22.5	15	F611DB473(1)1K0(2)
1000	250	0.056	DB	6	14.5	26	22.5	15	F611DB563(1)1K0(2)
1000	250	0.068	DB	6	14.5	26	22.5	15	F611DB683(1)1K0(2)
1000	250	0.082	DB	6	14.5	26	22.5	15	F611DB823(1)1K0(2)
1000	250	0.1	DB	6	14.5	26	22.5	15	F611DB104(1)1K0(2)
1000	250	0.12	DI	7	16	26	22.5	15	F611DI124(1)1K0(2)
1000	250	0.15	DI	7	16	26	22.5	15	F611DI154(1)1K0(2)
1000	250	0.18	DH	8	16	26	22.5	15	F611DH184(1)1K0(2)
1000	250	0.22	DM	9	18.5	26	22.5	15	F611DM224(1)1K0(2)
1000	250	0.27	DO	10	18.5	26	22.5	15	F611DO274(1)1K0(2)
1000	250	0.33	DP	11	20	26	22.5	15	F611DP334(1)1K0(2)
1000	250	0.39	DU	13	22	26	22.5	15	F611DU394(1)1K0(2)
1000	250	0.47	DU	13	22	26	22.5	15	F611DU474(1)1K0(2)
1000	250	0.56	DY	15.5	24.5	26	22.5	15	F611DY564(1)1K0(2)
1000	250	0.68	DY	15.5	24.5	26	22.5	15	F611DY684(1)1K0(2)
1000	250	0.15	FB	9	17	31.5	27.5	12	F611FB154(1)1K0(2)
1000	250	0.18	FB	9	17	31.5	27.5	12	F611FB184(1)1K0(2)
1000	250	0.22	FB	9	17	31.5	27.5	12	F611FB224(1)1K0(2)
1000	250	0.27	FB	9	17	31.5	27.5	12	F611FB274(1)1K0(2)
1000	250	0.33	FB	9	17	31.5	27.5	12	F611FB334(1)1K0(2)
1000	250	0.39	FC	11	20	31.5	27.5	12	F611FC394(1)1K0(2)
1000	250	0.47	FC	11	20	31.5	27.5	12	F611FC474(1)1K0(2)
1000	250	0.56	FI	13	25	31.5	27.5	12	F611FI564(1)1K0(2)
1000	250	0.68	FI	13	25	31.5	27.5	12	F611FI684(1)1K0(2)
1000	250	0.82	FN	14	28	31.5	27.5	12	F611FN824(1)1K0(2)
1000	250	1	FR	17.5	28	31.5	27.5	12	F611FR105(1)1K0(2)
1000	250	1.2	FR	17.5	28	31.5	27.5	12	F611FR125(1)1K0(2)
1000	250	1.5	FS	19	29	31.5	27.5	12	F611FS155(1)1K0(2)
1000	250	1.8	FY	22	37	31.5	27.5	12	F611FY185(1)1K0(2)
1000	250	2.2	FY	22	37	31.5	27.5	12	F611FY225(1)1K0(2)
1000	250	0.47	RB	11	22	41	37.5	10	F611RB474(1)1K0(2)
1000	250	0.56	RB	11	22	41	37.5	10	F611RB564(1)1K0(2)
1000	250	0.68	RB	11	22	41	37.5	10	F611RB684(1)1K0(2)
1000	250	0.82	RF	13	24	41	37.5	10	F611RF824(1)1K0(2)
1000	250	1	RF	13	24	41	37.5	10	F611RF105(1)1K0(2)
1000	250	1.2	RH	15	26	41	37.5	10	F611RH125(1)1K0(2)
1000	250	1.5	RC	16	28.5	41	37.5	10	F611RC155(1)1K0(2)
1000	250	1.8	RD	19	32	41	37.5	10	F611RD185(1)1K0(2)
1000	250	2.2	RD	19	32	41	37.5	10	F611RD225(1)1K0(2)
1000	250	2.7	RP	21	38	41	37.5	10	F611RP275(1)1K0(2)
1000	250	3.3	RO	24	44	41	37.5	10	F611RO335(1)1K0(2)
1000	250	3.9	RO	24	44	41	37.5	10	F611RO395(1)1K0(2)
1000	250	4.7	RU	30	45	41	37.5	10	F611RU475(1)1K0(2)
1000	250	5.6	RU	30	45	41	37.5	10	F611RU565(1)1K0(2)
VDC	VAC	Capacitance Value (µF)	Size Code	B (mm)	H (mm)	L (mm)	Lead Spacing (p)	dV/dt (V/µs)	Part Number

(1) K = ±10%, M = ±20%, J = ±5% on request.

(2) Insert lead and packaging code. See table for available options.

Soldering Process

The implementation of the RoHS Directive has required the selection SnAuCu (SAC) alloys or SnCu alloys as primary solder. This has increased the liquidus temperature from that of 183°C for SnPb eutectic alloy to 217°C – 221°C for the new alloys. As a result, the heat stress to components, even in wave soldering, has increased considerably due to higher pre-heat and wave temperatures. Wave soldering can be destructive especially for mechanically small polypropylene capacitors and great care must be taken during soldering. The solder profiles from KEMET are highly recommended. You may also refer to the wave soldering curve from IEC Publication 61760–1 Edition 2. Please consult KEMET with any questions.

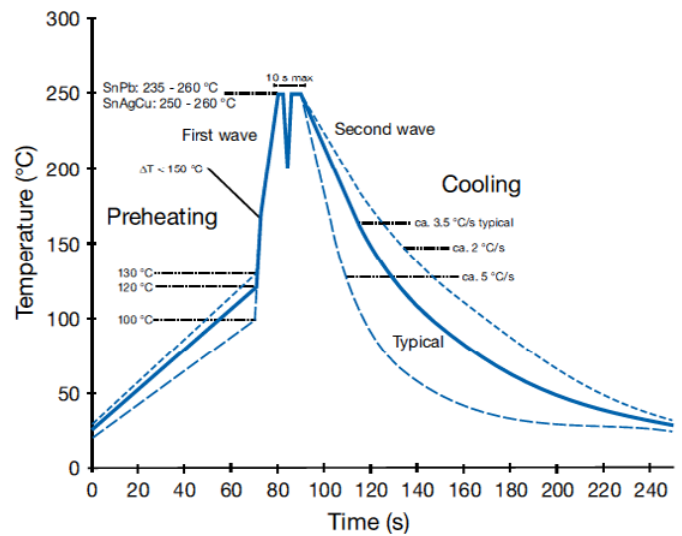

Marking

- KEMET's logo
- Series
- Capacitance
- Capacitance tolerance
- Rated voltage
- IEC climatic category
- Passive flammability class
- Manufacturing date code

Packaging Quantities

Size Code	Lead Spacing	Thickness (mm)	Height (mm)	Length (mm)	Bulk Short Leads	Bulk Long Leads	Standard Reel ø 355 mm	Large Reel ø 500 mm	Ammo	Pizza
JF	5	2.5	6.5	7.2	3000	4000	2500		3500	
JG		3.5	7.5	7.2	2000	3000	1800		2500	
JM		4.5	9.5	7.2	1500	2000	1400		1900	
JQ		5.0	10.0	7.2	1000	1500	1200		1700	
JT		6	11	7.2	2000	1000	1000		1400	
JU		7.2	13	7.2	1500	750	800		1150	
KE	7.5	2.5	6	10	2000	3000	2500		3500	
KF		3	8	10	1500	1750	2100		2800	
KG		4	8	10	2000	1500	1500		2100	
KJ		5	10.5	10	1500	1000	1200		1600	
KM		6	12	10.5	1000	800	1000		1350	
KH		4	9	10	2000	1500	1500		2100	
AN	10	3.5	9	13	2200	3200	850	1700	1150	
AG		4	9	13	2000	2200	750	1500	1000	
AK		5	11	13	1300	2000	600	1250	800	
AP		6	12	13	1000	1800	500	1000	680	
AO		7	17	13	600	900	450	900	580	
AL		9.5	7.5	13	1100	2000	300	600	430	
AE		4	8	13	2000	2200	750	1500	1000	
BB	15	4	10	18	1300	1500	750	1500	1000	1411
BC		5	11	18	1000	1250	600	1250	800	1139
BE		5.5	12.5	18	800	1100	550	1100	750	1020
BG		6	12	18	1750	1000	500	1000	680	935
BK		7.5	13.5	18	1000	800	350	800	500	748
BI		6	17.5	18	1000	800	500	1000	680	935
BP		8.5	14.5	18	1000	650	300	700	440	663
BT		9	12.5	18	1000	700	270	650	410	629
BO		7.5	18.5	18	900	600	350	800	500	748
BS		10	16	18	750	550	300	600	380	561
BR		13	12	18	750	520	200	480	280	425
BY		11	19	18	450	400	250	500	340	510
BA		8.5	12.5	18	1000	650	300	700	440	663
BZ		12	20	18	350	300	220	450	330	459

Packaging Quantities cont'd

Size Code	Lead Spacing	Thickness (mm)	Height (mm)	Length (mm)	Bulk Short Leads	Bulk Long Leads	Standard Reel ø 355 mm	Large Reel ø 500 mm	Ammo	Pizza
DB	22.5	6	14.5	26	1638	702	300	700	464	660
DI		7	16	26	1188	594	250	550	380	564
DH		8.0	16.0	26	1026	513	240	500	330	492
DJ		8.5	17	26	972	486	250	450	280	468
DM		9	18.5	26	918	459	200	400	300	444
DO		10	18.5	26	810	405	160	350	235	396
DP		11	20	26	756	378	190	350	217	360
DU		13	22	26	540	324	150	300	200	300
DY		15.5	24.5	26	450	270	120	250	170	252
FB	27.5	9.0	17.0	31.5	816	408				370
FC		11.0	20.0	31.5	672	336				300
FI		13.0	25.0	31.5	480	288				250
FN		14.0	28.0	31.5	352	176				230
FO		17.0	40.0	31.5	216	144				190
FR		17.5	28.0	31.5	256	128				190
FS		19.0	29.0	31.5	256	128				170
FY		22.0	37.0	31.5	168	112				150
FH		21.0	12.5	31.5	392	168				150
FQ		27.5	16.0	31.5	280	120				120
FT		31.0	19.0	31.5	240	120				100
RB	37.5	11.0	22.0	41.0	420	252				210
RF		13.0	24.0	41.0	360	216				175
RH		15.0	26.0	41.0	300	180				154
RC		16.0	28.5	41.0	216	108				140
RD		19.0	32.0	41.0	192	96				119
RP		21.0	38.0	41.0	126	84				105
RO		24.0	44.0	41.0	108	72				91
RU		30.0	45.0	41.0	90	60				77
RV		24.0	15.0	41.0	252	108				91
RW		24.0	19.0	41.0	216	108				91

Lead Taping & Packaging (IEC 60286–2)

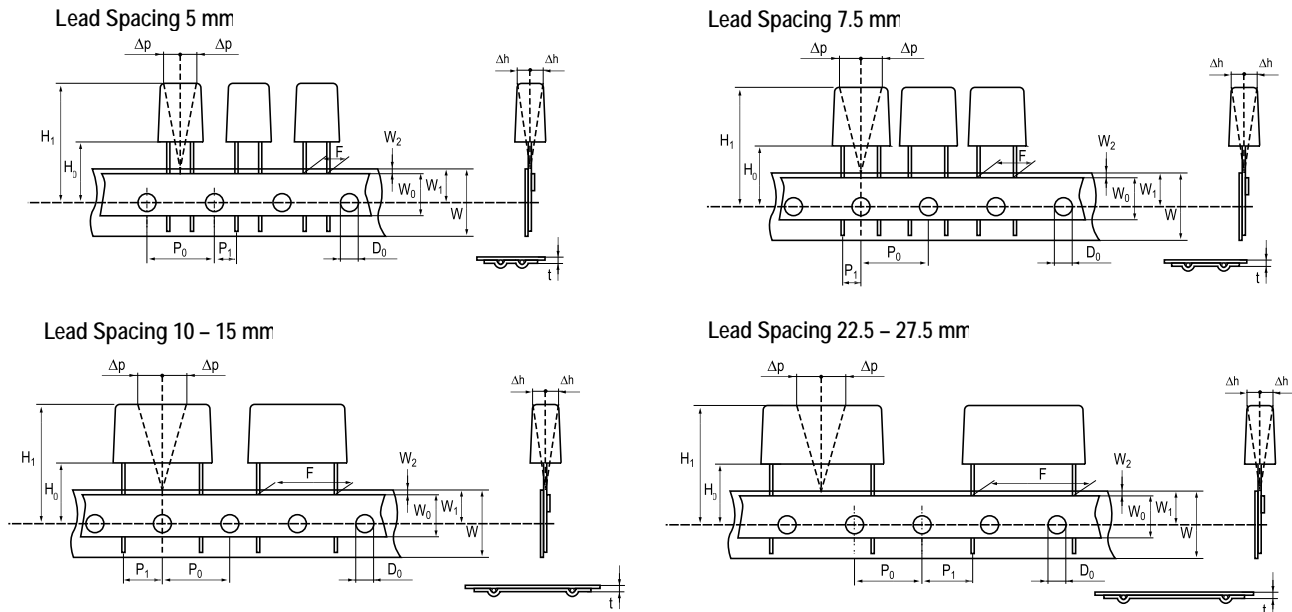

Taping Specification

Dimensions in mm									Standard IEC 60286–2
Lead spacing	+6/-0.1	F	5	7.5	10	15	22.5	27.5	F
Carrier tape width	+1/-0.5	W	18	18	18	18	18	18	18 ^{+1/-0.5}
Hold-down tape width	Minimum	W ₀	6	6	9	10	10	10	
Position of sprocket hole	+/-0.5	W ₁	9	9	9	9	9	9	9 ^{+0.75/-0.5}
Distance between tapes	Maximum	W ₂	3	3	3	3	3	3	3
Sprocket hole diameter	+/-0.2	D ₀	4	4	4	4	4	4	4
Feed hole lead spacing	+/-0.2 ⁽¹⁾	P ₀ ⁽³⁾	12.7	12.7	12.7	12.7	12.7	12.7	12.7
Distance lead – feed hole	+/-0.7	P ₁	3.85	3.75	7.7	5.2	7.8	5.3	P ¹
Deviation tape – plane	Maximum	Δp	1.3	1.3	1.3	1.3	1.3	1.3	1.3
Lateral deviation	+/-2	Δh	2	2	2	2	2	2	2
Total thickness	+/-0.2	t	0.7	0.7	0.7	0.7	0.9 ^{MAX}	0.9 ^{MAX}	0.9 ^{MAX}
Sprocket hole/cap body	+/-0.5	H ₀ ⁽²⁾	18.5 ^{+/-0.5}	18.5 ^{+/-0.5}	18.5 ^{+/-0.5}	18.5 ^{+/-0.5}	18.5 ^{+/-0.5}	18.5 ^{+/-0.5}	18 ^{+2/-0}

(1) Maximum cumulative feed hole error, 1 mm per 20 parts.

(2) 16.5 mm available on request.

(3) 15 mm available on request (F ≥ 10 mm).

Lead Taping & Packaging (IEC 60286–2) cont'd

Ammo Specifications

Series	Dimensions (mm)		
	H	W	T
R4x, R4x+R, R7x, RSB	360	340	59
F5A, F5B, F5D			
F6xx, F8xx			
PHExxx, PMExxx, PMRxxx	330	330	50

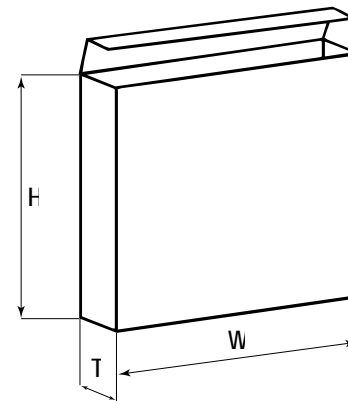

Reel Specifications

Series	Dimensions (mm)		
	D	H	W
R4x, R4x+R, R7x, RSB	355 500	30	55 (Max)
F5A, F5B, F5D		25	
F6xx, F8xx			
PHExxx, PMExxx, PMRxxx	360 500	30	46 (Max)

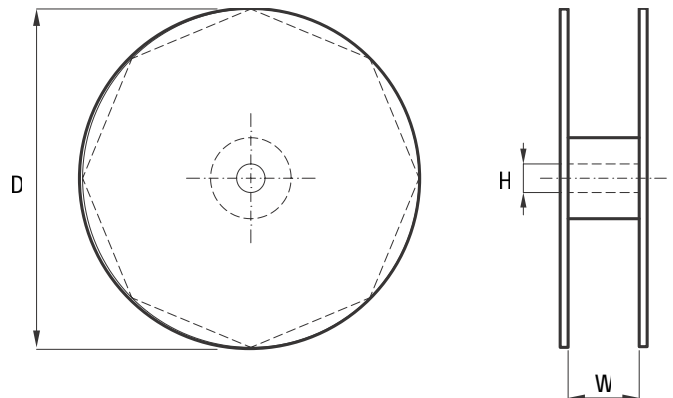

Manufacturing Date Code (IEC–60062)

Y = Year, Z = Month			
Year	Code	Month	Code
2000	M	January	1
2001	N	February	2
2002	P	March	3
2003	R	April	4
2004	S	May	5
2005	T	June	6
2006	U	July	7
2007	V	August	8
2008	W	September	9
2009	X	October	O
2010	A	November	N
2011	B	December	D
2012	C		
2013	D		
2014	E		
2015	F		
2016	H		
2017	J		
2018	K		
2019	L		
2020	M		

KEMET Corporation World Headquarters

2835 KEMET Way
Simpsonville, SC 29681

Mailing Address:
P.O. Box 5928
Greenville, SC 29606

www.kemet.com
Tel: 864-963-6300
Fax: 864-963-6521

Corporate Offices
Fort Lauderdale, FL
Tel: 954-766-2800

North America

Southeast

Lake Mary, FL
Tel: 407-855-8886

Northeast

Wilmington, MA
Tel: 978-658-1663

Central

Novi, MI
Tel: 248-994-1030

West

Milpitas, CA
Tel: 408-433-9950

Mexico

Guadalajara, Jalisco
Tel: 52-33-3123-2141

Europe

Southern Europe

Paris, France
Tel: 33-1-4646-1006

Sasso Marconi, Italy
Tel: 39-051-939111

Central Europe

Landsberg, Germany
Tel: 49-8191-3350800

Kamen, Germany
Tel: 49-2307-438110

Northern Europe

Bishop's Stortford, United Kingdom
Tel: 44-1279-460122

Espoo, Finland
Tel: 358-9-5406-5000

Asia

Northeast Asia

Hong Kong
Tel: 852-2305-1168

Shenzhen, China
Tel: 86-755-2518-1306

Beijing, China
Tel: 86-10-5829-1711

Shanghai, China
Tel: 86-21-6447-0707

Taipei, Taiwan
Tel: 886-2-27528585

Southeast Asia

Singapore
Tel: 65-6586-1900

Penang, Malaysia
Tel: 60-4-6430200

Bangalore, India
Tel: 91-806-53-76817

Note: KEMET reserves the right to modify minor details of internal and external construction at any time in the interest of product improvement. KEMET does not assume any responsibility for infringement that might result from the use of KEMET Capacitors in potential circuit designs. KEMET is a registered trademark of KEMET Electronics Corporation.

Other KEMET Resources

Tools	
Resource	Location
Configure A Part: CapEdge	http://capacitoredge.kemet.com
SPICE & FIT Software	http://www.kemet.com/spice
Search Our FAQs: KnowledgeEdge	http://www.kemet.com/keask
Electrolytic LifeCalculator	http://www.kemet.com:8080/elc

Product Information	
Resource	Location
Products	http://www.kemet.com/products
Technical Resources (Including Soldering Techniques)	http://www.kemet.com/technicalpapers
RoHS Statement	http://www.kemet.com/rohs
Quality Documents	http://www.kemet.com/qualitydocuments

Product Request	
Resource	Location
Sample Request	http://www.kemet.com/sample
Engineering Kit Request	http://www.kemet.com/kits

Contact	
Resource	Location
Website	www.kemet.com
Contact Us	http://www.kemet.com/contact
Investor Relations	http://www.kemet.com/ir
Call Us	1-877-MyKEMET
Twitter	http://twitter.com/kemetcapacitors

Disclaimer

All product specifications, statements, information and data (collectively, the "Information") in this datasheet are subject to change. The customer is responsible for checking and verifying the extent to which the Information contained in this publication is applicable to an order at the time the order is placed.

All Information given herein is believed to be accurate and reliable, but it is presented without guarantee, warranty, or responsibility of any kind, expressed or implied.

Statements of suitability for certain applications are based on KEMET Electronics Corporation's ("KEMET") knowledge of typical operating conditions for such applications, but are not intended to constitute – and KEMET specifically disclaims – any warranty concerning suitability for a specific customer application or use. The Information is intended for use only by customers who have the requisite experience and capability to determine the correct products for their application. Any technical advice inferred from this Information or otherwise provided by KEMET with reference to the use of KEMET's products is given gratis, and KEMET assumes no obligation or liability for the advice given or results obtained.

Although KEMET designs and manufactures its products to the most stringent quality and safety standards, given the current state of the art, isolated component failures may still occur. Accordingly, customer applications which require a high degree of reliability or safety should employ suitable designs or other safeguards (such as installation of protective circuitry or redundancies) in order to ensure that the failure of an electrical component does not result in a risk of personal injury or property damage.

Although all product-related warnings, cautions and notes must be observed, the customer should not assume that all safety measures are indicated or that other measures may not be required.

