

# Ultra-Low Power Consumption Low-Saturation Three-Pin Regulators with On/Off Pin Monolithic ICs MM1065 and 1165

## Outline

These ICs are stabilized power supply devices with ultra-low consumption currents, designed for a greatly reduced reactive current at low input voltages, and with a small input/output difference voltage of 0.2V at an output current of 40mA. The output current is limited to a maximum of 100mA, and in the MMP-4A package, an on/off pin enables the device to be switched on and off.

## Features

- |  |  |
|--|--|
| 1. Input/output voltage difference                               | 0.2V typ. (I <sub>o</sub> =40mA)   |
| 2. No-load input current   | 13μA typ.  |
| 3. Maximum reactive current at low input voltages                | 15μA typ. (no-load)  |
| 4. Maximum output current  | 100mA max.   |
| 5. Temperature coefficient of output voltage                     | ±0.01%/°C typ.   |
| 6. Output voltage ranks  | MM1065, 1165    F : 6.0V±4%<br>G : 5.0V±4%<br>H : 4.5V±4%<br>I : 4.0V±4%<br>J : 3.0V±4%<br>Z : 3.3V±4% |
| 7. With overcurrent protection circuit                           |  |
| 8. With thermal shutdown circuit                                 |  |
| 9. With function to turn output on and off (MMP-4A package only) |  |

On/Off Pin Level	Low	High
MM1065 output	ON	OFF
MM1165 output	OFF	ON

## Package

TO-92A (MM1065□T, MM1165□T)

MMP-4A (MM1065□M, MM1165□M)

\*The output voltage rank appears in the boxes.

## Applications

1. Handheld computers
2. Portable transceivers
3. Cordless phones
4. Other portable equipment which uses batteries

## Absolute Maximum Ratings

Item	Symbol	Ratings	Units
Operating temperature	T <sub>OPR</sub>	-20~+75	°C
Storage temperature	T <sub>STG</sub>	-40~+125	°C
Power supply current	V <sub>CC</sub> max.	-0.3~10	V
Output current	I <sub>OUT</sub>	100	mA
Maximum Ratings	P <sub>d</sub>	200 (MMP-4A) 300 (TO-92A)	mW

## Electrical Characteristics

Item	Symbol	Measurement conditions	Min.	Typ.	Max.	Units	
Output voltage	V <sub>O</sub>	V <sub>IN</sub> =V <sub>O</sub> +1V I <sub>O</sub> =40mA	F	5.76	6.00	6.24	V
			G	4.80	5.00	5.20	
			H	4.32	4.50	4.68	
			I	3.84	4.00	4.16	
			J	2.88	3.00	3.12	
			Z	3.17	3.30	3.43	
No-load input current	I <sub>ccq1</sub>	V <sub>IN</sub> =V <sub>O</sub> +1V, I <sub>O</sub> =0mA		13	20	μA	
Minimum I/O voltage difference	V <sub>d</sub> min.	V <sub>IN</sub> =V <sub>O</sub> min., I <sub>O</sub> =40mA		0.2	0.3	V	
Input fluctuation rate	ΔV <sub>2</sub>	V <sub>IN</sub> =(V <sub>O</sub> +1V)~10V, I <sub>O</sub> =40mA		±0.01	±0.1	%/V	
Load fluctuation rate	ΔV <sub>1</sub>	V <sub>IN</sub> =V <sub>O</sub> +1V, I <sub>O</sub> =0~100mA		±0.01	±0.03	%/mA	
Output voltage temperature coefficient	ΔV <sub>O</sub> /T	T <sub>j</sub> =-20~+75°C		±100		ppm/°C	
Ripple rejection rate	RR	V <sub>RI</sub> =1V, V <sub>IN</sub> =V <sub>O</sub> +2V f=120Hz, I <sub>O</sub> =40mA	50	60		dB	

## Equivalent Circuit Diagram

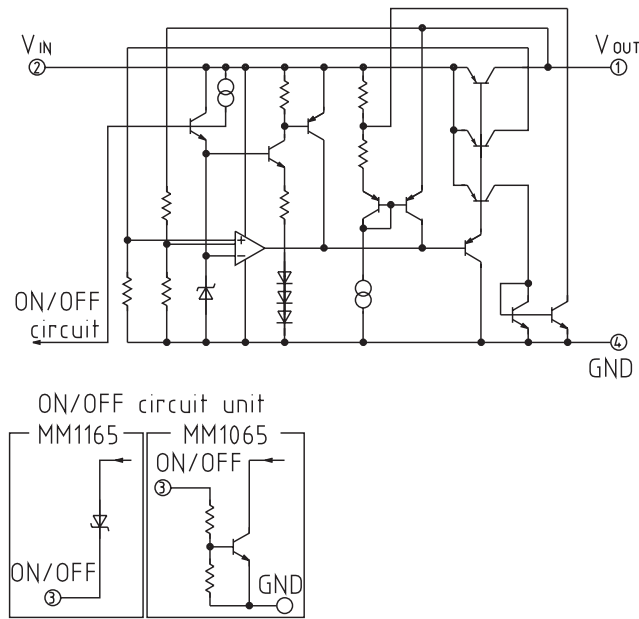

## Electrical Characteristics (MMP-4P)

Item	Symbol	Measurement conditions		Min.	Typ.	Max.	Units
Input current while off	I <sub>ccq2</sub>	MM1065	V <sub>IN</sub> =6V V(ON/OFF)=High		2.5	7	μA
		MM1165	V <sub>IN</sub> =6V V(ON/OFF)=Low		3	6	μA
On/off pin current while off	I <sub>OFF</sub>	MM1065	V(ON/OFF)=2.4V		4	7	μA
		MM1165	V(ON/OFF)=0.4V		0.2	0.1	μA
On/off pin level							
On/off pin high level	High			2.4		V <sub>IN</sub> +0.3	V
On/off pin low level	Low			-0.3		0.4	V

## Basic Circuit Connection Diagram

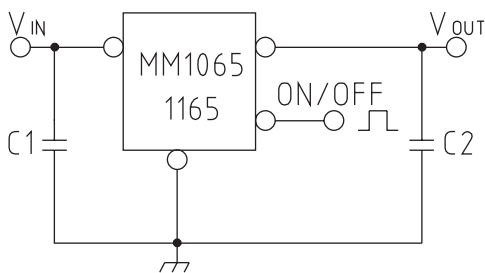

[ C1 ≥ 1μF (ceramic)  
C2 ≥ 1μF (ceramic)

On/Off Pin Level	Low	High
MM1065 output	ON	OFF
MM1165 output	OFF	ON

## Characteristics

I/O voltage difference

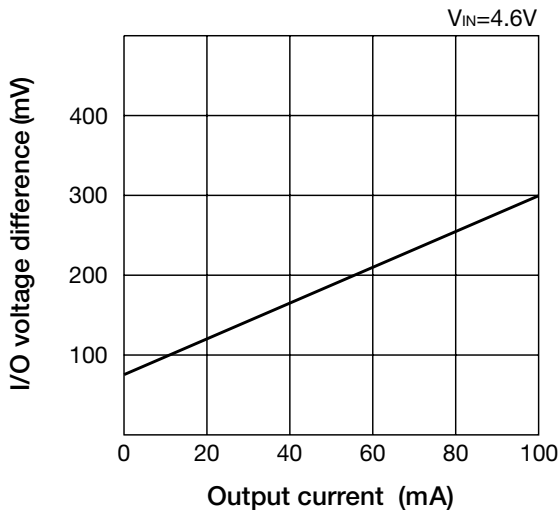

No-load input current

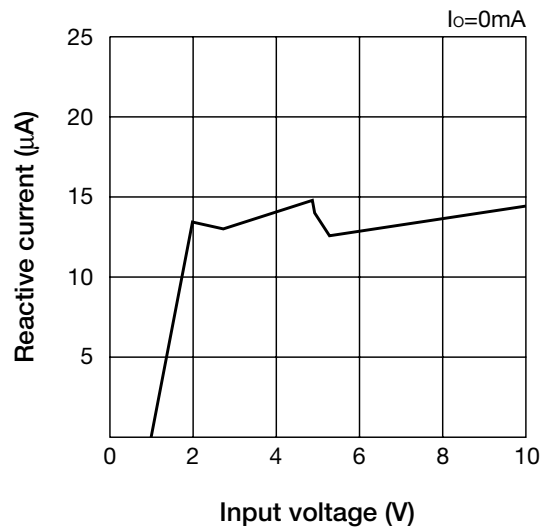

Load fluctuation rate

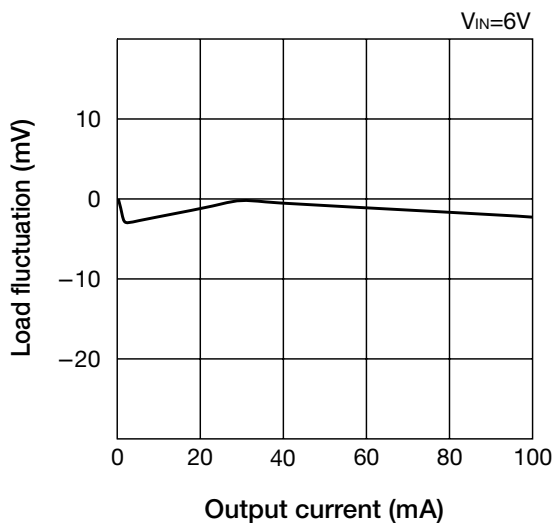

Input fluctuation rate

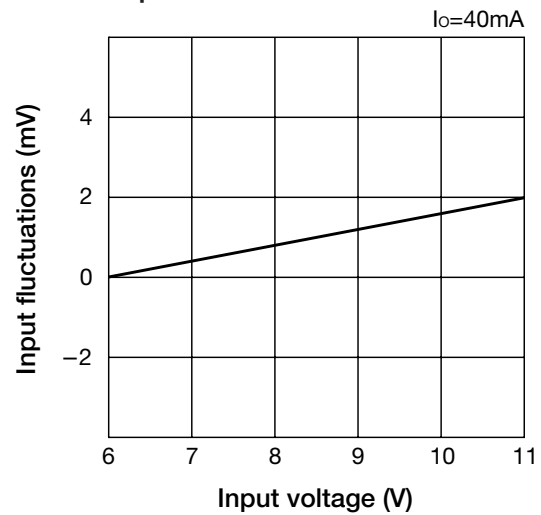

Output voltage characteristic

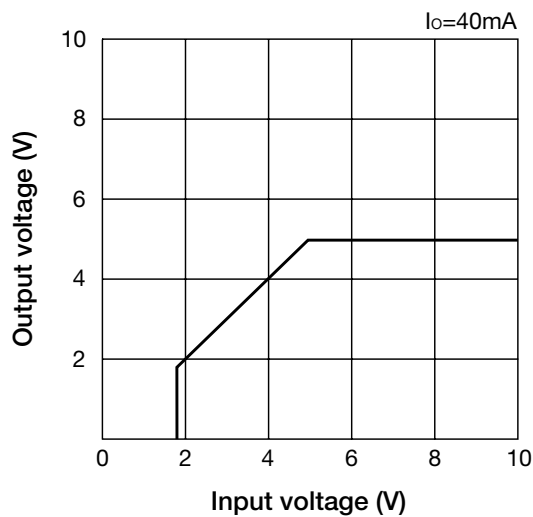

Output voltage temperature characteristic

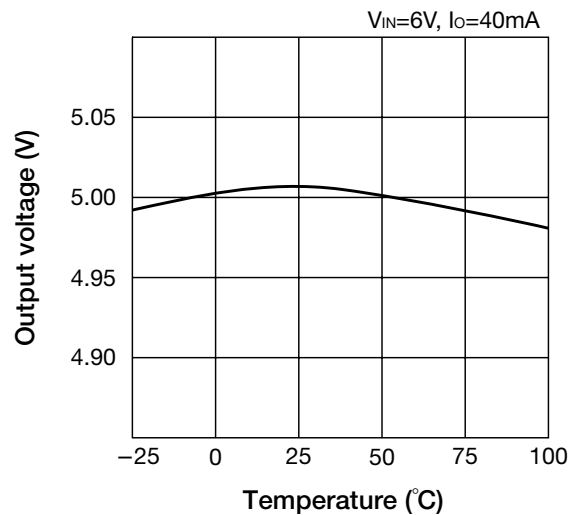

■ Load transient response

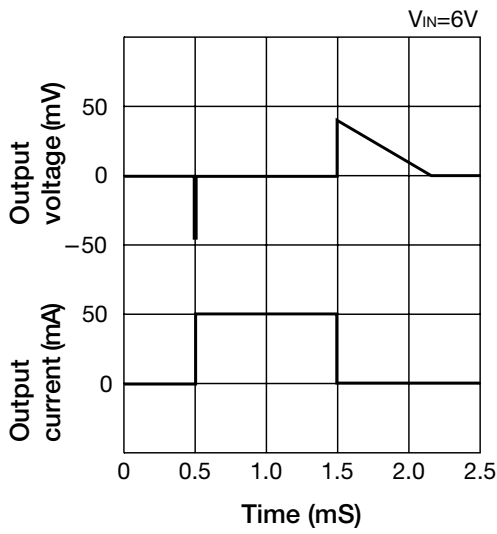

■ Transient response to input fluctuation

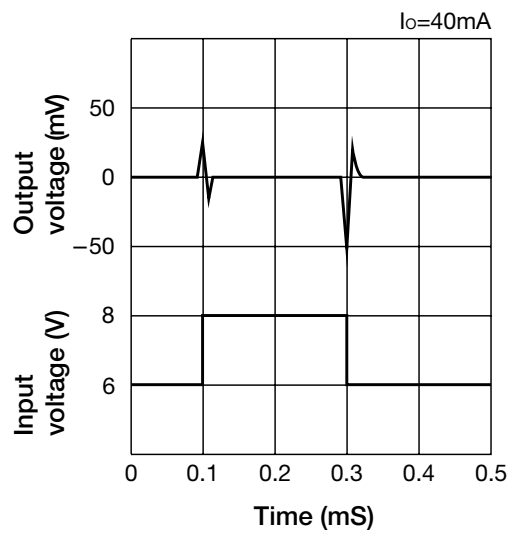

■ Allowable loss

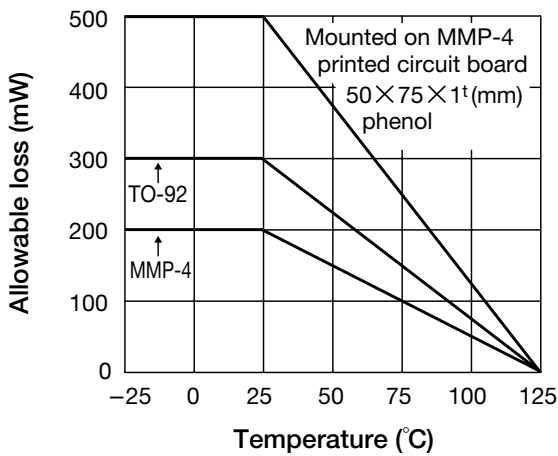

■ Ripple rejection rate

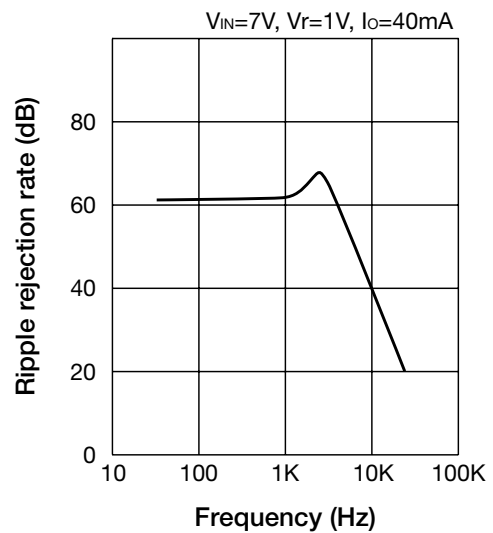

■ Thermal shutdown

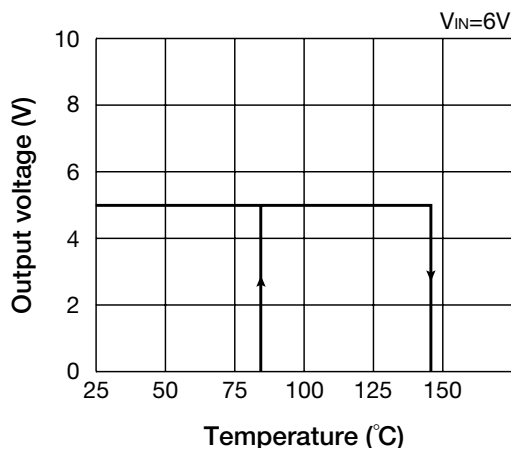

■ Output current characteristic

