

Microminiature Low-Noise, Low-Saturation Three-Pin Regulator Monolithic IC MM1320

Outline

This IC is a microminiature low-noise stabilized power supply device featuring a highly precise output voltage and a small input/output voltage difference of only 0.15V at an output current of 60mA.

The IC delivers output currents of up to 200mA, and through use of a noise pin output noise is diminished even further. An on/off pin can be used to turn the output on and off.

Features

- | | |
|---|---|
| 1. Input/output voltage difference | 0.15V typ. ($I_o=60\text{mA}$) |
| 2. Output noise voltage | $30\mu\text{V}_{\text{RMS}}$ typ. ($C_n=0.01\mu\text{F}$) |
| 3. Maximum output current | 150mA max. |
| 4. No-load input current | $170\mu\text{A}$ typ. |
| 5. With internal overcurrent protection and thermal shutdown circuits | |
| 6. Output voltage ranks | 2~3.3V (0.1 V steps)
3.5V, 4V, 4.5V, 5V |
| 7. Output on/off control function | High : ON, Low : OFF |

Package

SOT-25A (MM1320□N)

*The output voltage rank appears in the boxes.

Applications

1. Cordless phones
2. Portable phones, PHS
3. Portable minidisks
4. Other portable equipment which uses batteries

Pin Assignment

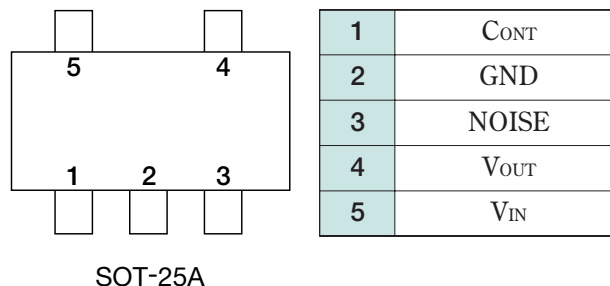

Equivalent Circuit Diagram

(MM1320)

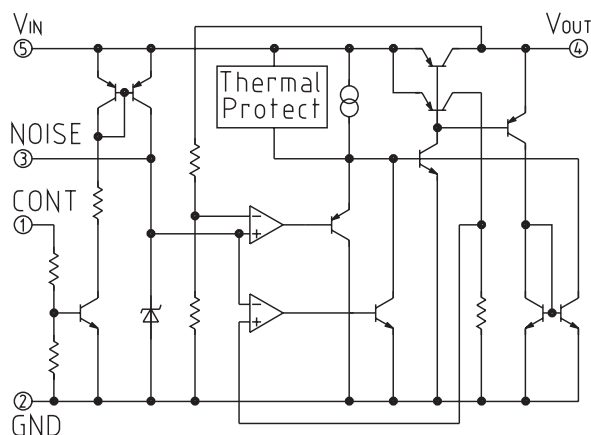

Absolute Maximum Ratings

Item	Symbol	Ratings	Units
Storage temperature	T_{STG}	-40~+125	°C
Operating temperature	T_{OPR}	-20~+75	°C
Power supply current	V_{CC}	-0.3~+12	V
Output current	I_{OUT}	200	mA
Power consumption	P_d	150	mW

Recommended Operating Conditions

Item	Symbol	Ratings	Units
Operating temperature	T_{OPS}	-20~+75	°C
Output current	I_{OPS}	150	mA
Operating voltage	V_{OP}	1.8~10	V

Electrical Characteristics (Except where noted otherwise, Ta=25°C)

Item	Symbol	Measurement conditions	Min.	Typ.	Max.	Units
Output voltage	V _o	V _{IN} =V _{OUT} +1V, I _o =30mA	V _{OUT} -2%	V _{OUT}	V _{OUT} +2%	V
No-load consumption current	I _{ccq1}	V _{IN} =V _{OUT} +1V, I _o =0mA		170	340	μA
Input current while off	I _{ccq2}	V _{IN} =V _{OUT} +1V, V _{cont} =0V			1	μA
I/O voltage difference	V _{d min.}	V _{IN} =V _{OUT} -0.2V, I _o =60mA		0.15	0.25	V
Input fluctuations	ΔV ₁	V _{IN} =V _{OUT} +1V~5V, I _o =30mA		10	20	mV
Load fluctuation	ΔV ₂	I _o =0~100mA, V _{IN} =V _{OUT} +1V		30	60	mV
Output voltage temperature coefficient	ΔV _o /ΔT	T _j =-20~+75°C, I _o =30mA V _{IN} =V _{OUT} +1V		100		ppm/°C
Ripple rejection rate	RR	V _{IN} =V _{OUT} +1V, f=120Hz V _{RIPPLE} =1V, I _o =30mA	50	60		dB
Output noise voltage	V _n	V _{IN} =V _{OUT} +1V, f=20~80kHz I _o =30mA, C _{noise} =0.01μF		30 (3V item)		μVrms
CONT pin current while off	I _{OFF}	V _{cont} =0.4V		1	3	μA
CONT pin current while on	I _{ON}	V _{cont} =1.6V		5	10	μA
CONT pin high level	H		1.6		V _{IN} +0.3	V
CONT pin low level	L		-0.3		0.4	V

Measuring Circuit

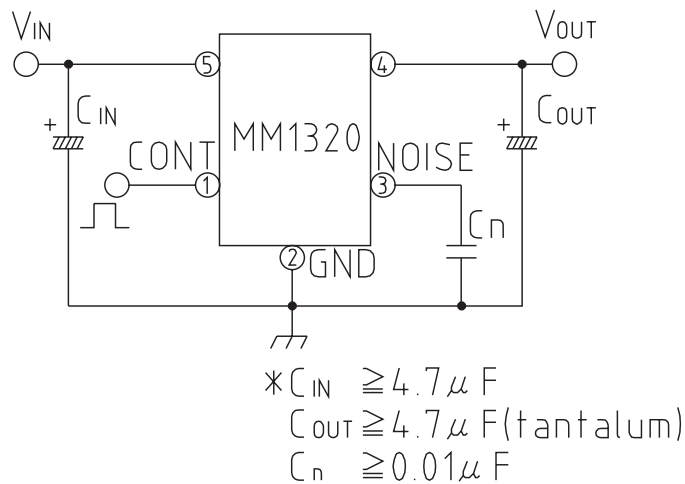

Output voltage rank

Rnak	Voltage	Rnak	Voltage
A	5.0V	K	2.8V
B	4.5V	L	2.7V
C	4.0V	M	2.6V
D	3.5V	N	2.5V
E	3.3V	P	2.4V
F	3.2V	R	2.3V
G	3.1V	S	2.2V
H	3.0V	T	2.1V
J	2.9V	U	2.0V

Characteristics (MM1320)

I/O voltage difference

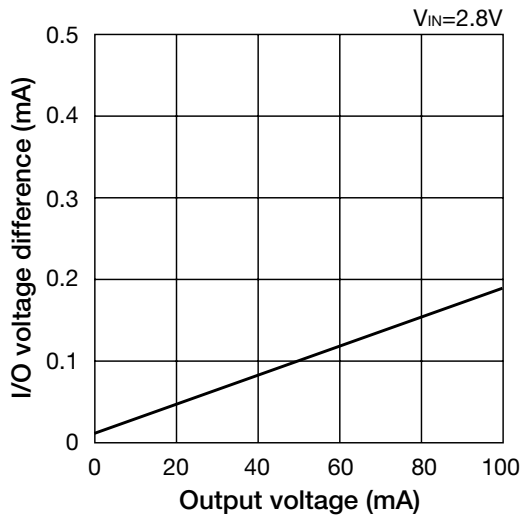

Allowable loss

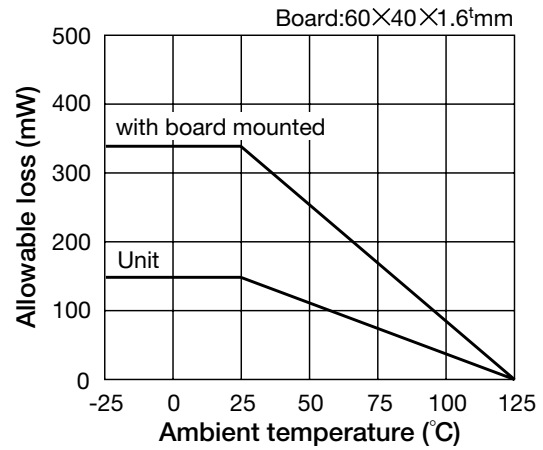

Output voltage temperature characteristic

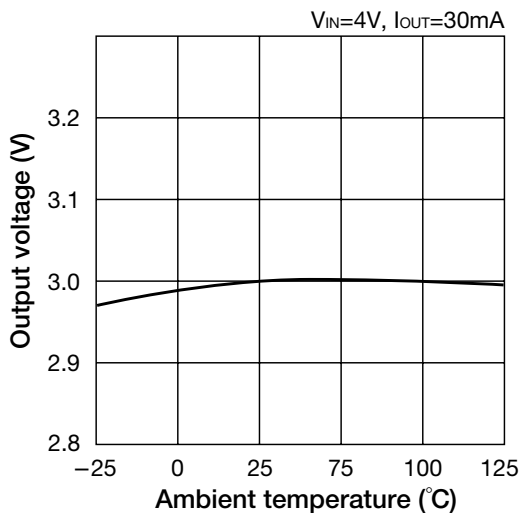

No-load consumption current

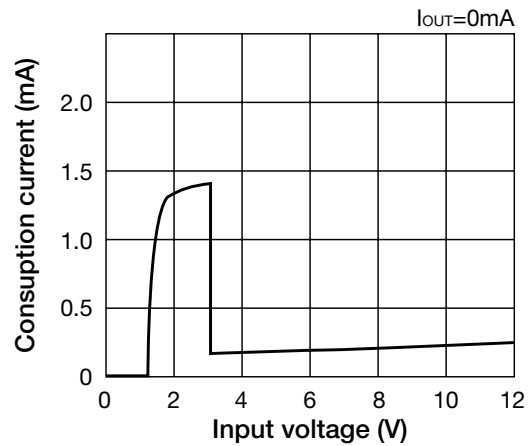

■ Output voltage

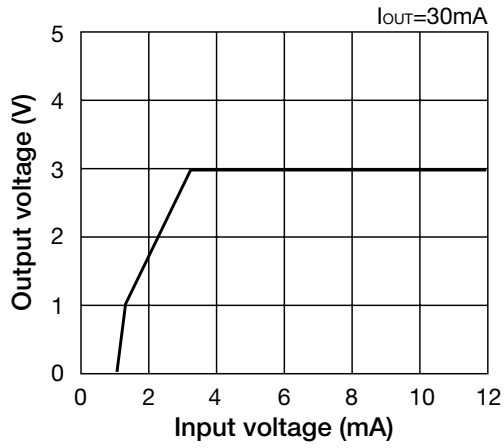

■ Input fluctuation

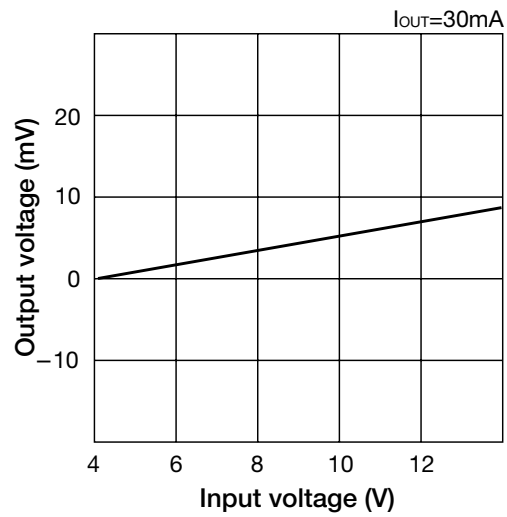

■ Load fluctuation

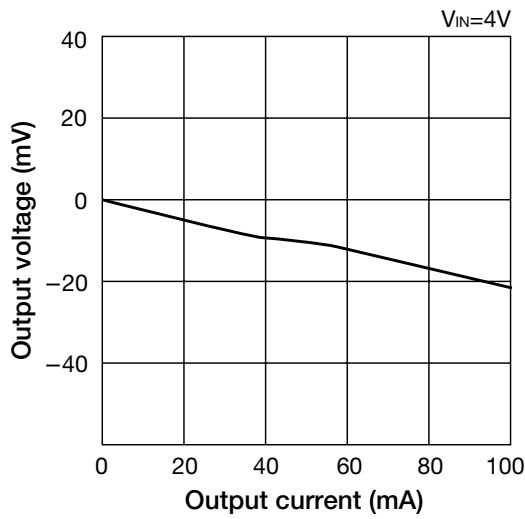

■ Current limit

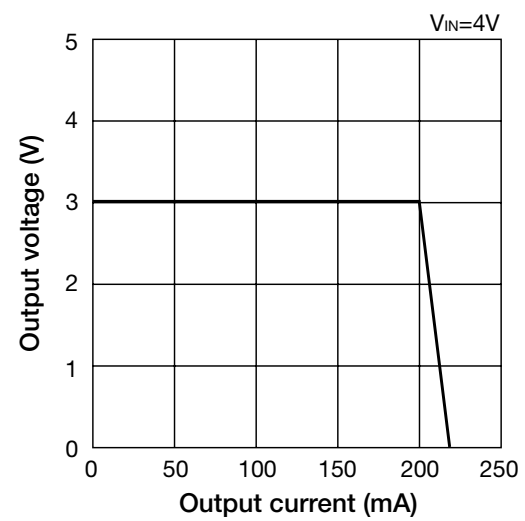

■ Ripple rejection rate

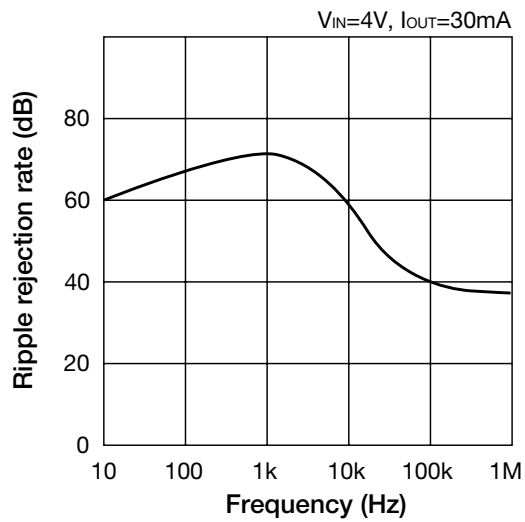

■ Input transient response

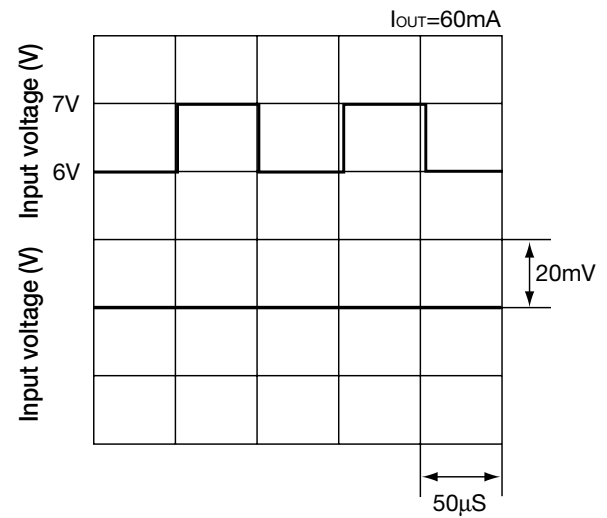

■ Output noise voltage

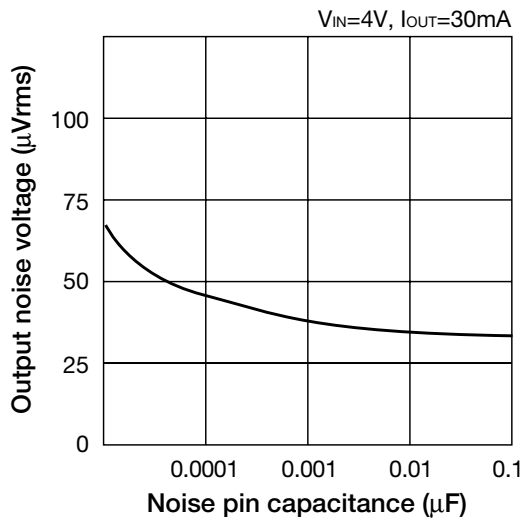

■ Input transient response

