

18-36V Continuous Input	50V Transient Input	5.0-50V Outputs	504W Max Power	2250V dc Isolation	Half-brick DC-DC Converter
-----------------------------------	-------------------------------	---------------------------	--------------------------	------------------------------	--------------------------------------

The InQor Half-brick converter series is composed of next-generation, board-mountable, fixed switching frequency dc-dc converters that use synchronous rectification to achieve extremely high power conversion efficiency. Each module is supplied completely encased to provide protection from the harsh environments seen in many industrial and transportation applications.



Operational Features

- High efficiency, 94% at full rated load current
- Operating input voltage range: 18-36V
- Fixed frequency switching provides predictable EMI
- No minimum load requirement
- Optional: Active current share for parallel applications

Mechanical Features

- Industry standard Half-brick pin-out
- Size: 2.386" x 2.486" x 0.512" (60.60 x 63.14 x 13.00 mm)
- Total weight: 4.9 oz (139 g)
- Flanged baseplate version available

Control Features

- On/Off control referenced to input side
- Remote sense for the output voltage
- Wide output voltage trim range of at least -50%, +10%

Safety Features

- UL 60950-1/R:2011-12 Basic Insulation
- CAN/CSA-C22.2 No. 60950-1/A1:2011
- EN 60950-1/A12:2011
- RoHS compliant (see last page)

Protection Features

- Input under-voltage lockout
- Output current limit and short circuit protection
- Active back bias limit
- Auto-recovery output over-voltage protection
- Thermal shutdown

CONTENTS

	Page No.
Family Electrical Characteristics	2
Electrical Characteristics (5.0 Vout) & Figures	4
Electrical Characteristics (12 Vout) & Figures	6
Electrical Characteristics (15 Vout) & Figures	8
Electrical Characteristics (24 Vout) & Figures	10
Electrical Characteristics (28 Vout) & Figures	12
Electrical Characteristics (40 Vout) & Figures	14
Electrical Characteristics (50 Vout) & Figures	16
Application Section	18
Standards & Qualification Testing	24
Standard Mechanical Diagram	25
Flanged Mechanical Diagram	26
Ordering Information	27

IQ24 FAMILY ELECTRICAL CHARACTERISTICS (all output voltages)

Ta = 25 °C, airflow rate = 300 LFM, Vin = 24V dc unless otherwise noted; full operating temperature range is -40 °C to +100 °C baseplate temperature with appropriate power derating. Specifications subject to change without notice.

Parameter	Min.	Typ.	Max.	Units	Notes & Conditions
ABSOLUTE MAXIMUM RATINGS					
Input Voltage					
Non-Operating	-1		50	V	Continuous
Operating			40	V	Continuous
Operating Transient Protection			50	V	1 s transient, square wave
Isolation Voltage					
Input to Output			2250	V dc	
Input to Base-Plate			2250	V dc	
Output to Base-Plate			2250	V dc	
Operating Temperature	-40		100	°C	Baseplate temperature
Storage Temperature	-45		125	°C	
Voltage at ON/OFF input pin	-2		18	V	
INPUT CHARACTERISTICS					
Operating Input Voltage Range	18	24	36	V	50V transient for 1 s
Input Under-Voltage Lockout					
Turn-On Voltage Threshold	16.5	17.0	17.5	V	
Turn-Off Voltage Threshold	15.0	15.5	16.0	V	
Lockout Voltage Hysteresis	1.0	1.5	2.0	V	
Input Over-Voltage Shutdown		-		V	Not Available
Recommended External Input Capacitance		470		µF	Typical ESR 0.1-0.2 Ω
Input Filter Component Values (C1, L1, C2)		47\0.34\23		nF\µH\µF	Internal values; see Figure D
DYNAMIC CHARACTERISTICS					
Turn-On Transient					
Turn-On Time	24	35	40	ms	Full load, Vout=90% nom; See Note 2
Output Voltage Overshoot			5	%	Maximum Output Capacitance
Auto-recovery Startup Inhibit Time		500		ms	See Application Section
ISOLATION CHARACTERISTICS					
Isolation Voltage (dielectric strength)					See Absolute Maximum Ratings
Isolation Resistance		30		MΩ	
Isolation Capacitance (input to output)		1000		pF	See Note 1
TEMPERATURE LIMITS FOR POWER DERATING CURVES					
Semiconductor Junction Temperature			125	°C	Package rated to 150 °C
Board Temperature			125	°C	UL rated max operating temp 130 °C
Transformer Temperature			125	°C	
Maximum Baseplate Temperature, Tb			100	°C	
FEATURE CHARACTERISTICS					
Switching Frequency	230	240	250	kHz	Insulation stage switching freq. is half this
ON/OFF Control					
Off-State Voltage	2.4		18.0	V	
On-State Voltage	-2.0		0.8		
ON/OFF Control					Application notes Figure A
Pull-Up Voltage		5\15	5.5\18	V\V	28, 50Vout\All Other Vout
Pull-Up Resistance		10\50		kΩ\kΩ	28, 50Vout\All Other Vout
Over-Temperature Shutdown OTP Trip Point		125		°C	Average PCB Temperature
Over-Temperature Shutdown Restart Hysteresis		10		°C	
RELIABILITY CHARACTERISTICS					
Calculated MTBF (Telcordia) TR-NWT-000332		1.44		10 ⁶ Hrs.	Tb = 70°C
Calculated MTBF (MIL-217) MIL-HDBK-217F		1.2		10 ⁶ Hrs.	Tb = 70°C
Field Demonstrated MTBF				10 ⁶ Hrs.	See our website for details

Note 1: Higher values of isolation capacitance can be added external to the module.

Note 2: Additional 30ms between enable and start of Turn-On time for full-featured units to set up communication (N/A to 28V and 50V)

Family Figures (all output voltages)

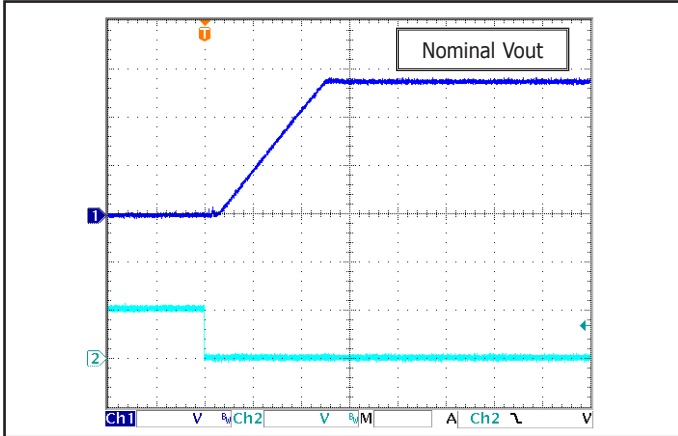

Common Figure 1: Startup Waveform (typical). Input voltage pre-applied, ON/OFF Pin on Ch 2.

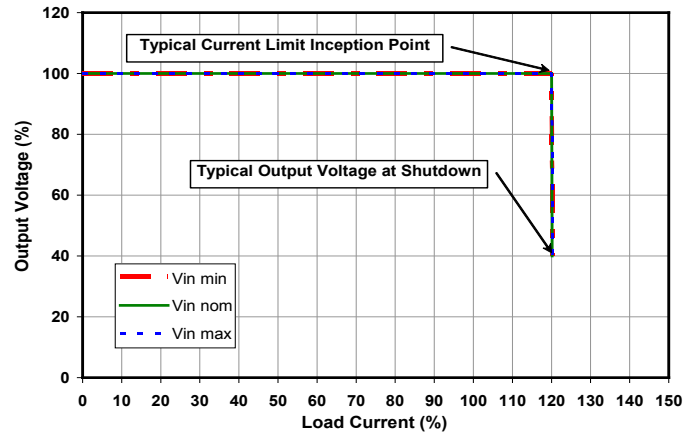

Common Figure 2: Output I-V Characteristics (output voltage vs. load current) showing typical current limit curves and converter shutdown points.

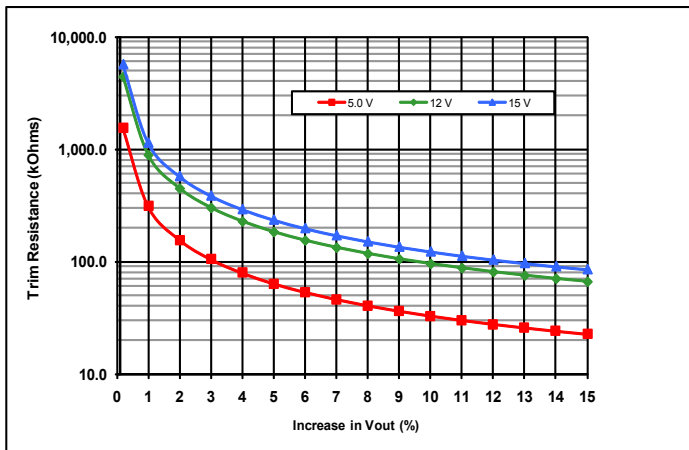

Common Figure 3: Trim-Up Graph for 5.0 to 15V outputs.

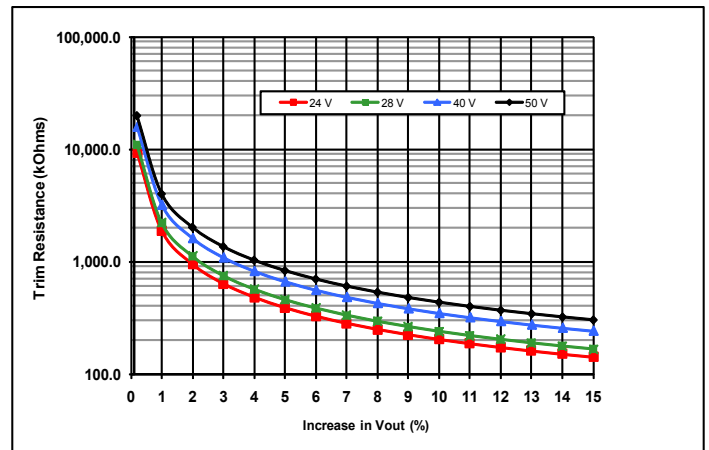

Common Figure 4: Trim-Up Graph for 24 to 50V outputs.

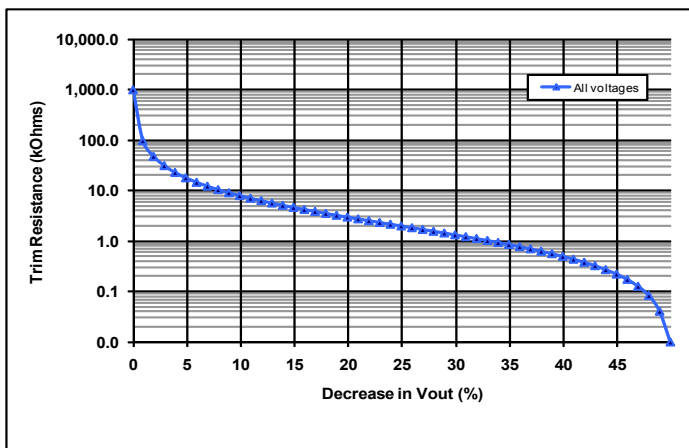

Common Figure 5: Trim-Down Graph for all outputs.

IQ24050HZx60 ELECTRICAL CHARACTERISTICS (5.0 Vout)

Ta = 25 °C, airflow rate = 300 LFM, Vin = 24V dc unless otherwise noted; full operating temperature range is -40 °C to +100 °C baseplate temperature with appropriate power derating. Specifications subject to change without notice.

Parameter	Min.	Typ.	Max.	Units	Notes & Conditions
INPUT CHARACTERISTICS					
Maximum Input Current			20	A	100% Load, 18V Vin, trimmed up 10%
No-Load Input Current		290	350	mA	
Disabled Input Current		3	5	mA	
Response to Input Transient		0.95		V	See Figure 6
Input Terminal Ripple Current		500		mA	RMS
Recommended Input Fuse			40	A	Fast acting external fuse recommended
OUTPUT CHARACTERISTICS					
Output Voltage Set Point	4.918	5.000	5.070	V	
Output Voltage Regulation					See Note 3
Over Line		±0.25		%	
Over Load		±0.25		%	
Over Temperature	-125		125	mV	
Total Output Voltage Range	4.850		5.150	V	Over sample, line, load, temperature & life
Output Voltage Ripple and Noise					20 MHz bandwidth; see Note 1
Peak-to-Peak		135		mV	Full load
RMS		32		mV	Full load
Operating Output Current Range	0		60	A	Subject to thermal derating
Output DC Current-Limit Inception	66.0	72.0	78.0	A	Output voltage 10% Low
Output DC Current-Limit Shutdown Voltage		2		V	See Note 2
Back-Drive Current Limit while Enabled		6		A	Negative current drawn from output
Back-Drive Current Limit while Disabled	0	3	4	mA	Negative current drawn from output
Maximum Output Capacitance			20,000	µF	Vout nominal at full load (resistive load)
Output Voltage during Load Current Transient					
Step Change in Output Current (0.2 A/µs)		150		mV	50% to 75% to 50% Iout max
Settling Time		500		µs	To within 1% Vout nom
Output Voltage Trim Range	-50		10	%	Across Pins 8&4; Common Figures 3-5;
Output Voltage Remote Sense Range			10	%	Across Pins 8&4
Output Over-Voltage Protection	5.9	6.2	6.4	V	Over full temp range
EFFICIENCY					
100% Load		92		%	See Figure 1 for efficiency curve
50% Load		93		%	See Figure 1 for efficiency curve

Note 1: Output is terminated with 1 µF ceramic and 15 µF low-ESR tantalum capacitors. For applications requiring reduced output voltage ripple and noise, consult SynQor applications support (e-mail: support@synqor.com)

Note 2: If the output voltage falls below the Output DC Current Limit Shutdown Voltage for more than 50ms, then the unit will enter into hiccup mode,

Note 3: Line and load regulation is limited by duty cycle quantization and does not indicate a shift in the internal voltage reference

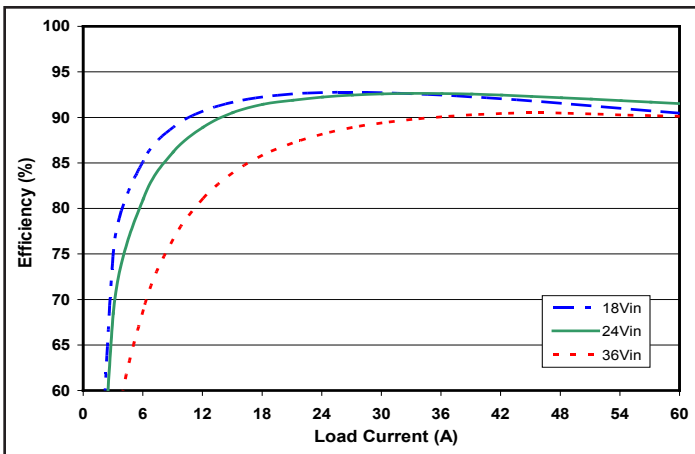

Figure 1: Efficiency at nominal output voltage vs. load current for minimum, nominal, and maximum input voltage at 25°C.

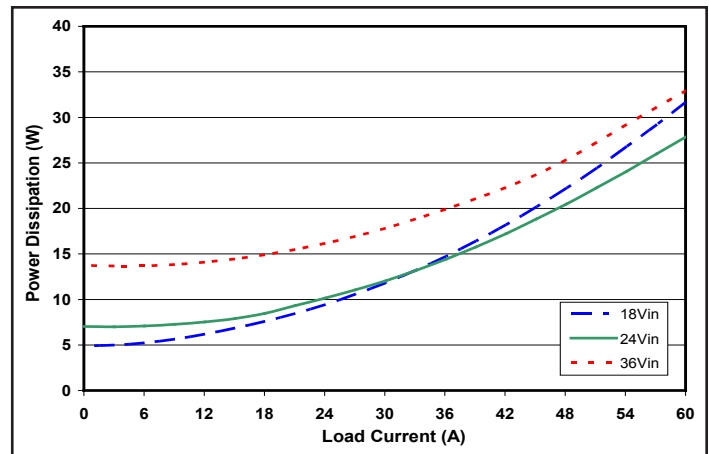

Figure 2: Power Dissipation at nominal output voltage vs. load current for minimum, nominal, and maximum input voltage at 25°C.

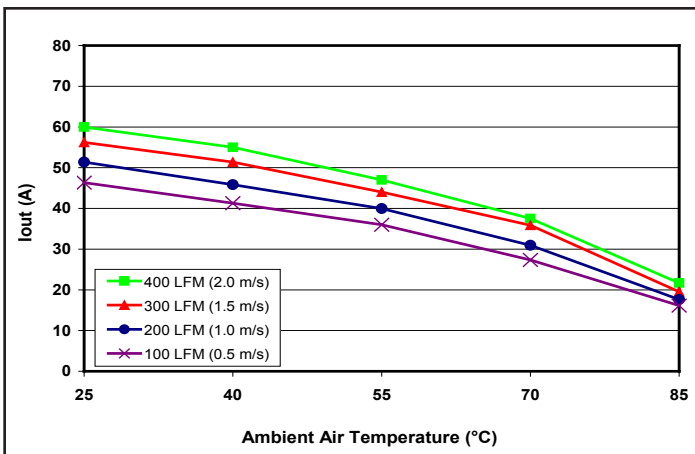

Figure 3: Thermal Derating (max output current vs. ambient air temperature) for encased converter without heatsink, at airflow rates of 100 LFM through 400 LFM. Air flows across the converter from input to output (nominal input voltage).

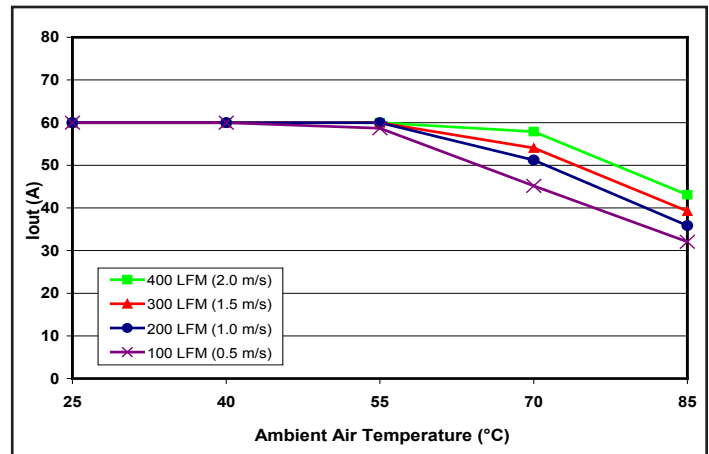

Figure 4: Thermal Derating (max output current vs. ambient air temperature) for encased converter with 1/2" heatsink, at airflow rates of 100 LFM through 400 LFM. Air flows across the converter from input to output (nominal input voltage).

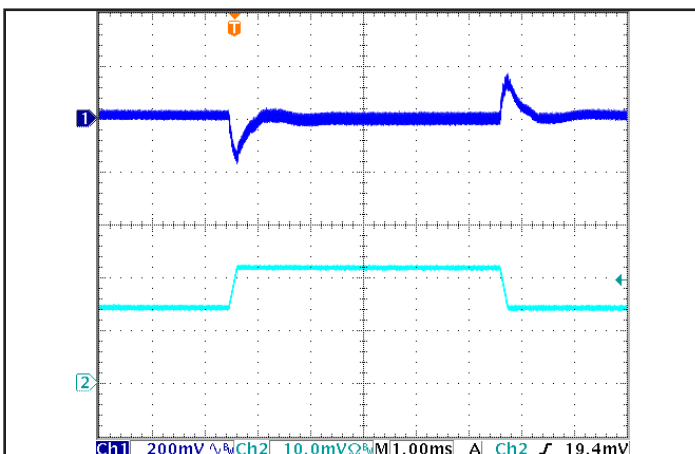

Figure 5: Output Voltage Response to Step-Change in Load Current (50%-75%-50% of Iout(max); dI/dt = 0.2A/μs). Load cap: 15μF tantalum cap and 1μF ceramic cap. Ch 1: Vout, Ch 2: Iout (20A/div).

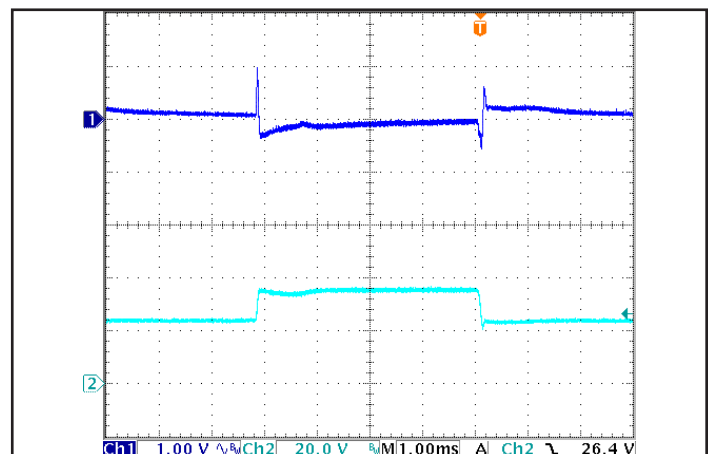

Figure 6: Output Voltage Response to Step-Change in Input Voltage (250 V/ms), at Max. load current. Load cap: 100μF electrolytic cap and 1μF ceramic cap. Ch 1: Vout, Ch 2: Vin.

IQ24120HZx42 ELECTRICAL CHARACTERISTICS (12.0 Vout)

Ta = 25 °C, airflow rate = 300 LFM, Vin = 24V dc unless otherwise noted; full operating temperature range is -40 °C to +100 °C baseplate temperature with appropriate power derating. Specifications subject to change without notice.

Parameter	Min.	Typ.	Max.	Units	Notes & Conditions
INPUT CHARACTERISTICS					
Maximum Input Current			33	A	100% Load, 18V Vin, trimmed up 10%
No-Load Input Current		310	375	mA	
Disabled Input Current		3	5	mA	
Response to Input Transient		2		V	See Figure 6
Input Terminal Ripple Current		500		mA	RMS
Recommended Input Fuse			40	A	Fast acting external fuse recommended
OUTPUT CHARACTERISTICS					
Output Voltage Set Point	11.80	12.00	12.17	V	
Output Voltage Regulation					See Note 3
Over Line		±0.25		%	
Over Load		±0.25		%	
Over Temperature	-300		300	mV	
Total Output Voltage Range	11.64		12.36	V	Over sample, line, load, temperature & life
Output Voltage Ripple and Noise					20 MHz bandwidth; see Note 1
Peak-to-Peak		100		mV	Full load
RMS		24		mV	Full load
Operating Output Current Range	0		42	A	Subject to thermal derating
Output DC Current-Limit Inception	46.2	50.4	54.6	A	Output voltage 10% Low
Output DC Current-Limit Shutdown Voltage		5		V	See Note 2
Back-Drive Current Limit while Enabled		6		A	Negative current drawn from output
Back-Drive Current Limit while Disabled		3	4	mA	Negative current drawn from output
Maximum Output Capacitance			12,000	µF	Vout nominal at full load (resistive load)
Output Voltage during Load Current Transient					
Step Change in Output Current (0.1 A/µs)		300		mV	50% to 75% to 50% Iout max
Settling Time		500		µs	To within 1% Vout nom
Output Voltage Trim Range	-50		10	%	Across Pins 8&4; Common Figures 3-5;
Output Voltage Remote Sense Range			10	%	Across Pins 8&4
Output Over-Voltage Protection	14.2	14.8	15.4	V	Over full temp range
EFFICIENCY					
100% Load		94		%	See Figure 1 for efficiency curve
50% Load		95		%	See Figure 1 for efficiency curve

Note 1: Output is terminated with 1 µF ceramic and 15 µF low-ESR tantalum capacitors. For applications requiring reduced output voltage ripple and noise, consult SynQor applications support (e-mail: support@synqor.com)

Note 2: If the output voltage falls below the Output DC Current Limit Shutdown Voltage for more than 50ms, then the unit will enter into hiccup mode,

Note 3: Line and load regulation is limited by duty cycle quantization and does not indicate a shift in the internal voltage reference

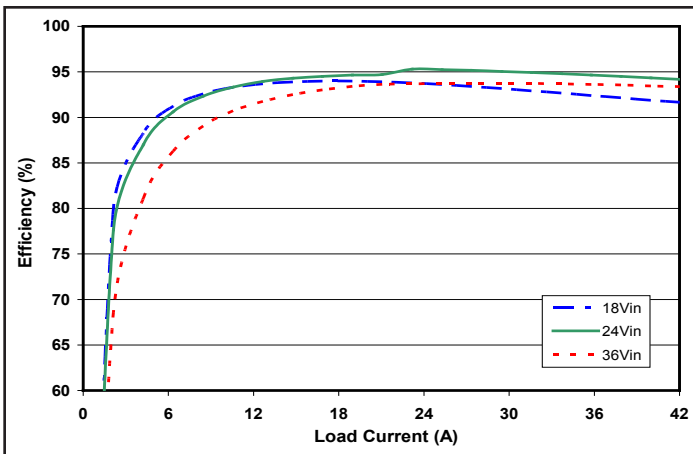

Figure 1: Efficiency at nominal output voltage vs. load current for minimum, nominal, and maximum input voltage at 25°C.

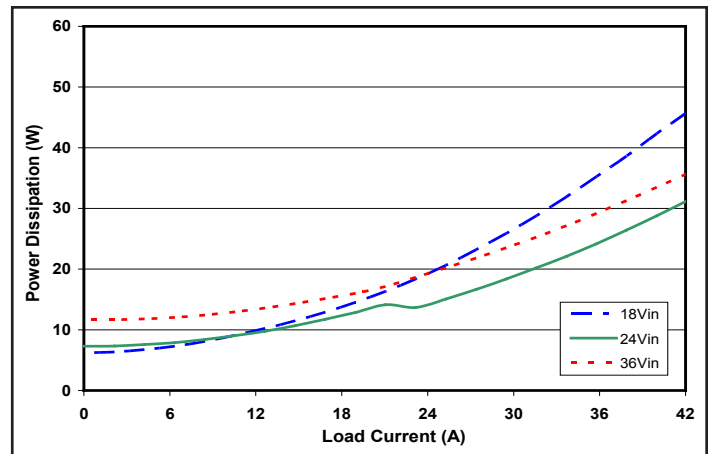

Figure 2: Power Dissipation at nominal output voltage vs. load current for minimum, nominal, and maximum input voltage at 25°C.

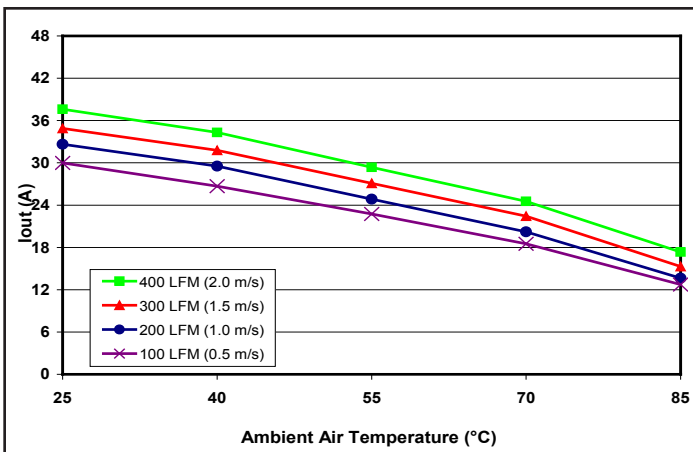

Figure 3: Thermal Derating (max output current vs. ambient air temperature) for encased converter without heatsink, at airflow rates of 100 LFM through 400 LFM. Air flows across the converter from input to output (nominal input voltage).

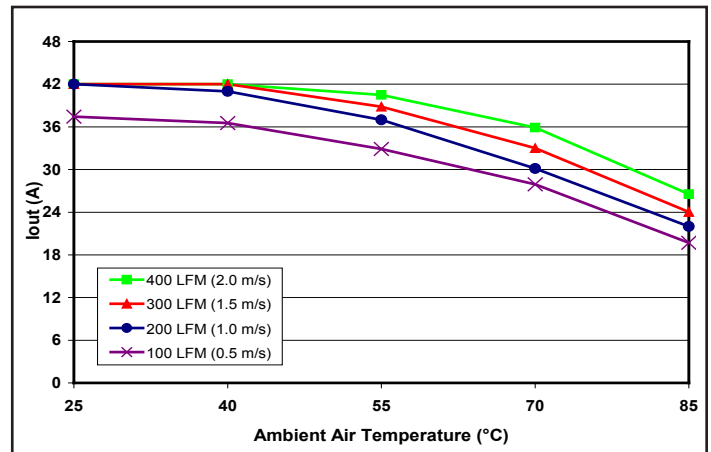

Figure 4: Thermal Derating (max output current vs. ambient air temperature) for encased converter with 1/2" heatsink, at airflow rates of 100 LFM through 400 LFM. Air flows across the converter from input to output (nominal input voltage).

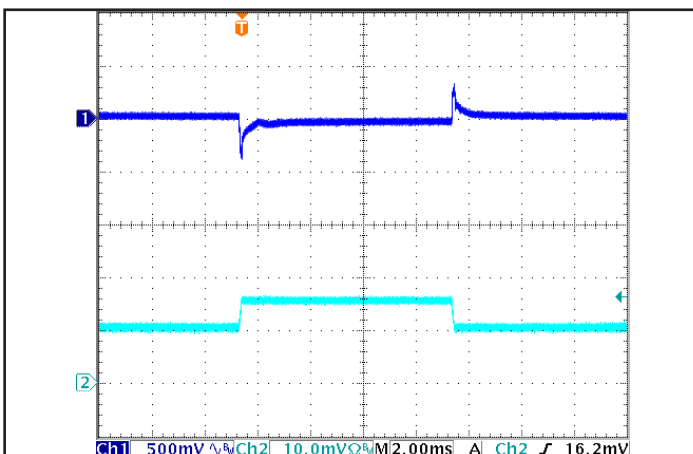

Figure 5: Output Voltage Response to Step-Change in Load Current (50%-75%-50% of Iout(max)); dI/dt = 0.1A/μs. Load cap: 15μF tantalum cap and 1μF ceramic cap. Ch 1: Vout, Ch 2: Iout (20 A/div).

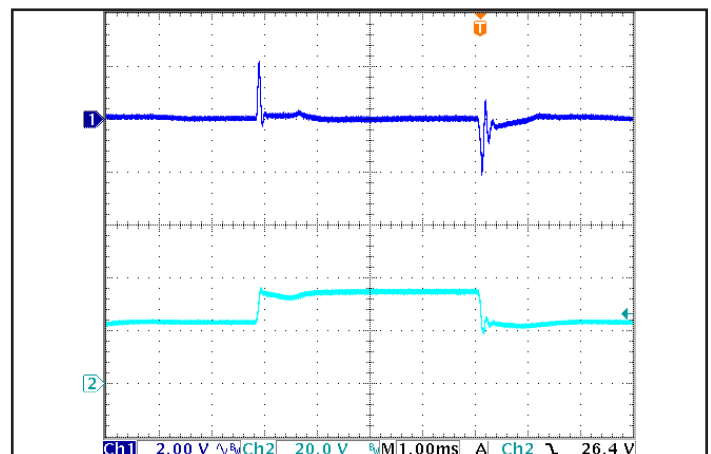

Figure 6: Output Voltage Response to Step-Change in Input Voltage (250 V/ms), at Max. load current. Load cap: 100μF electrolytic cap and 1μF ceramic cap. Ch 1: Vout, Ch 2: Vin.

IQ24150HZx34 ELECTRICAL CHARACTERISTICS (15.0 Vout)

Ta = 25 °C, airflow rate = 300 LFM, Vin = 24V dc unless otherwise noted; full operating temperature range is -40 °C to +100 °C baseplate temperature with appropriate power derating. Specifications subject to change without notice.

Parameter	Min.	Typ.	Max.	Units	Notes & Conditions
INPUT CHARACTERISTICS					
Maximum Input Current			34	A	100% Load, 18V Vin, trimmed up 10%
No-Load Input Current		340	400	mA	
Disabled Input Current		3	5	mA	
Response to Input Transient		2.5		V	See Figure 6
Input Terminal Ripple Current		500		mA	RMS
Recommended Input Fuse			40	A	Fast acting external fuse recommended
OUTPUT CHARACTERISTICS					
Output Voltage Set Point	14.75	15.00	15.21	V	
Output Voltage Regulation					See Note 3
Over Line		±0.25		%	
Over Load		±0.25		%	
Over Temperature	-375		375	mV	
Total Output Voltage Range	14.55		15.45	V	Over sample, line, load, temperature & life
Output Voltage Ripple and Noise					20 MHz bandwidth; see Note 1
Peak-to-Peak		100		mV	Full load
RMS		20		mV	Full load
Operating Output Current Range	0		34	A	Subject to thermal derating
Output DC Current-Limit Inception	37.4	40.8	44.2	A	Output voltage 10% Low
Output DC Current-Limit Shutdown Voltage		6		V	See Note 2
Back-Drive Current Limit while Enabled		6		A	Negative current drawn from output
Back-Drive Current Limit while Disabled		3	4	mA	Negative current drawn from output
Maximum Output Capacitance			10,000	µF	Vout nominal at full load (resistive load)
Output Voltage during Load Current Transient					
Step Change in Output Current (0.1 A/µs)		500		mV	50% to 75% to 50% Iout max
Settling Time		250		µs	To within 1% Vout nom
Output Voltage Trim Range	-50		10	%	Across Pins 8&4; Common Figures 3-5;
Output Voltage Remote Sense Range			10	%	Across Pins 8&4
Output Over-Voltage Protection	17.7	18.5	19.2	V	Over full temp range
EFFICIENCY					
100% Load		94.0		%	See Figure 1 for efficiency curve
50% Load		94.5		%	See Figure 1 for efficiency curve

Note 1: Output is terminated with 1 µF ceramic and 15 µF low-ESR tantalum capacitors. For applications requiring reduced output voltage ripple and noise, consult SynQor applications support (e-mail: support@synqor.com)

Note 2: If the output voltage falls below the Output DC Current Limit Shutdown Voltage for more than 50ms, then the unit will enter into hiccup mode, with a 500ms off-time

Note 3: Line and load regulation is limited by duty cycle quantization and does not indicate a shift in the internal voltage reference

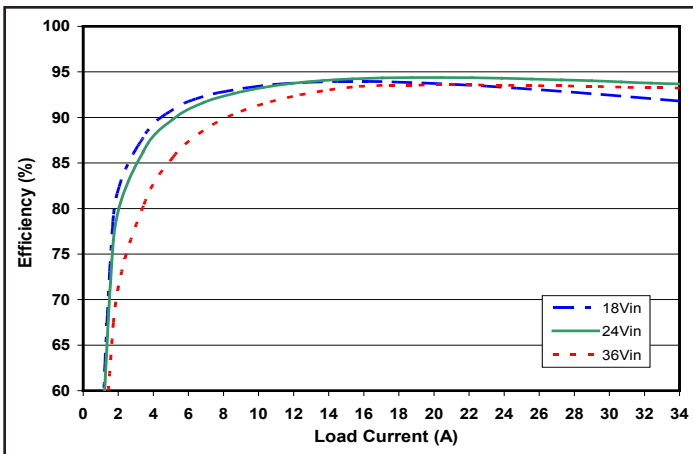

Figure 1: Efficiency at nominal output voltage vs. load current for minimum, nominal, and maximum input voltage at 25°C.

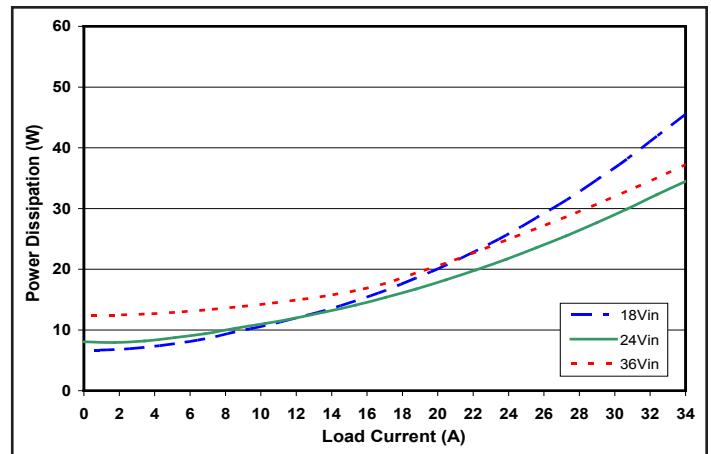

Figure 2: Power Dissipation at nominal output voltage vs. load current for minimum, nominal, and maximum input voltage at 25°C.

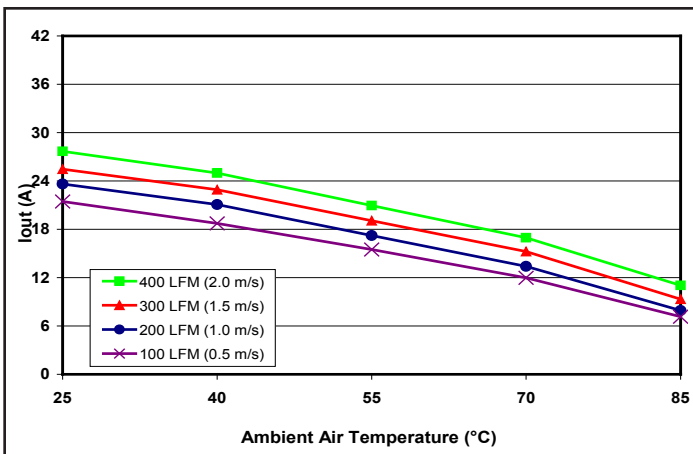

Figure 3: Thermal Derating (max output current vs. ambient air temperature) for encased converter without heatsink, at airflow rates of 100 LFM through 400 LFM. Air flows across the converter from input to output (nominal input voltage).

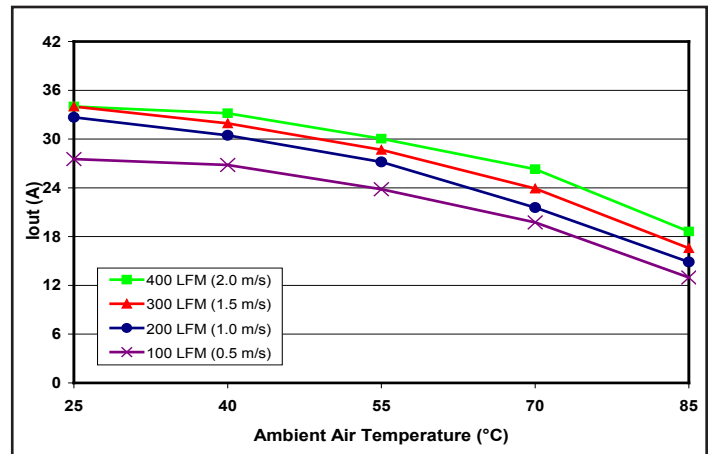

Figure 4: Thermal Derating (max output current vs. ambient air temperature) for encased converter with 1/2" heatsink, at airflow rates of 100 LFM through 400 LFM. Air flows across the converter from input to output (nominal input voltage).

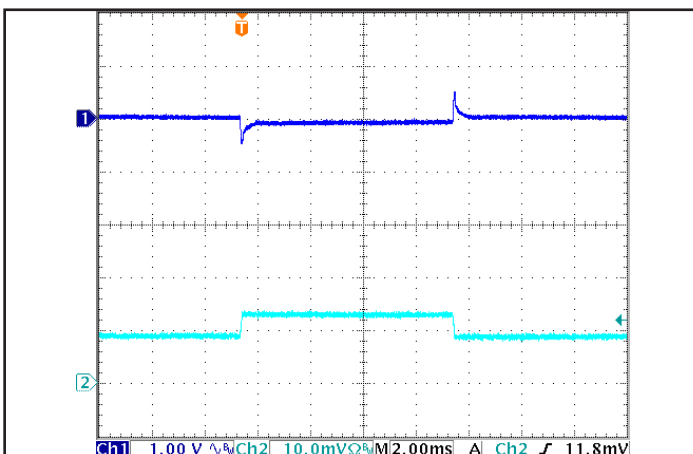

Figure 5: Output Voltage Response to Step-Change in Load Current (50%-75%-50% of I_{out}(max)); dI/dt = 0.1A/μs. Load cap: 15μF tantalum cap and 1μF ceramic cap. Ch 1: V_{out}, Ch 2: I_{out} (20 A/div).

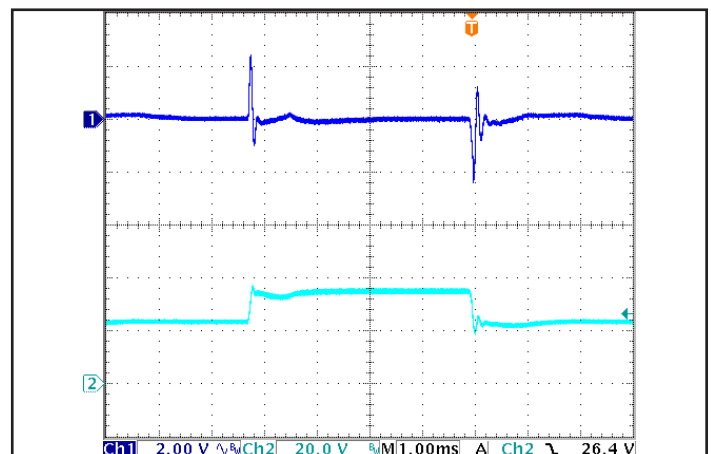

Figure 6: Output Voltage Response to Step-Change in Input Voltage (250 V/ ms), at Max. load current. Load cap: 100μF electrolytic cap and 1μF ceramic cap. Ch 1: V_{out}, Ch 2: V_{in}.

IQ24240HZx21 ELECTRICAL CHARACTERISTICS (24.0 Vout)

Ta = 25 °C, airflow rate = 300 LFM, Vin = 24V dc unless otherwise noted; full operating temperature range is -40 °C to +100 °C baseplate temperature with appropriate power derating. Specifications subject to change without notice.

Parameter	Min.	Typ.	Max.	Units	Notes & Conditions
INPUT CHARACTERISTICS					
Maximum Input Current			33	A	100% Load, 18V Vin, trimmed up 10%
No-Load Input Current		300	360	mA	
Disabled Input Current		3	5	mA	
Response to Input Transient		3		V	See Figure 6
Input Terminal Ripple Current		500		mA	RMS
Recommended Input Fuse			40	A	Fast acting external fuse recommended
OUTPUT CHARACTERISTICS					
Output Voltage Set Point	23.60	24.00	24.34	V	
Output Voltage Regulation					See Note 3
Over Line		±0.25		%	
Over Load		±0.25		%	
Over Temperature	-600		600	mV	
Total Output Voltage Range	23.28		24.72	V	Over sample, line, load, temperature & life
Output Voltage Ripple and Noise					20 MHz bandwidth; see Note 1
Peak-to-Peak		450		mV	Full load
RMS		150		mV	Full load
Operating Output Current Range	0		21	A	Subject to thermal derating
Output DC Current-Limit Inception	23.1	25.2	27.3	A	Output voltage 10% Low
Output DC Current-Limit Shutdown Voltage		9.6		V	See Note 2
Back-Drive Current Limit while Enabled		3		A	Negative current drawn from output
Back-Drive Current Limit while Disabled		3	4	mA	Negative current drawn from output
Maximum Output Capacitance			6000	µF	Vout nominal at full load (resistive load)
Output Voltage during Load Current Transient					
Step Change in Output Current (0.2 A/µs)		950		mV	50% to 75% to 50% Iout max
Settling Time		500		µs	To within 1% Vout nom
Output Voltage Trim Range	-50		10	%	Across Pins 8&4; Common Figures 3-5;
Output Voltage Remote Sense Range			10	%	Across Pins 8&4
Output Over-Voltage Protection	28.3	29.5	30.7	V	Over full temp range
EFFICIENCY					
100% Load		94		%	See Figure 1 for efficiency curve
50% Load		95		%	See Figure 1 for efficiency curve

Note 1: Output is terminated with 1 µF ceramic and 15 µF low-ESR tantalum capacitors. For applications requiring reduced output voltage ripple and noise, consult SynQor applications support (e-mail: support@synqor.com)

Note 2: If the output voltage falls below the Output DC Current Limit Shutdown Voltage for more than 50ms, then the unit will enter into hiccup mode, with a 500ms off-time

Note 3: Line and load regulation is limited by duty cycle quantization and does not indicate a shift in the internal voltage reference

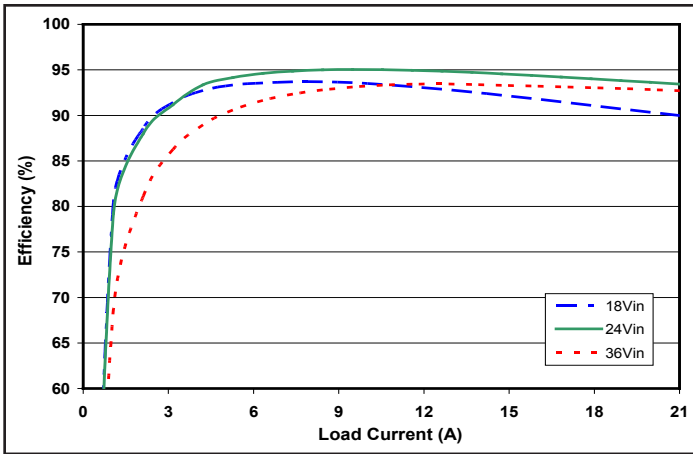

Figure 1: Efficiency at nominal output voltage vs. load current for minimum, nominal, and maximum input voltage at 25°C.

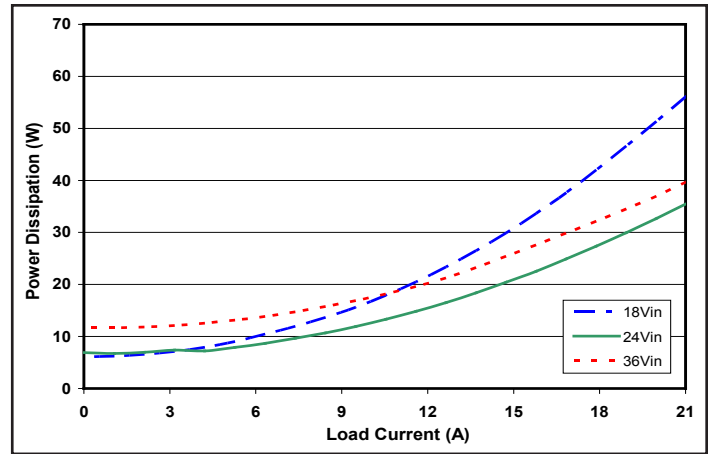

Figure 2: Power Dissipation at nominal output voltage vs. load current for minimum, nominal, and maximum input voltage at 25°C.

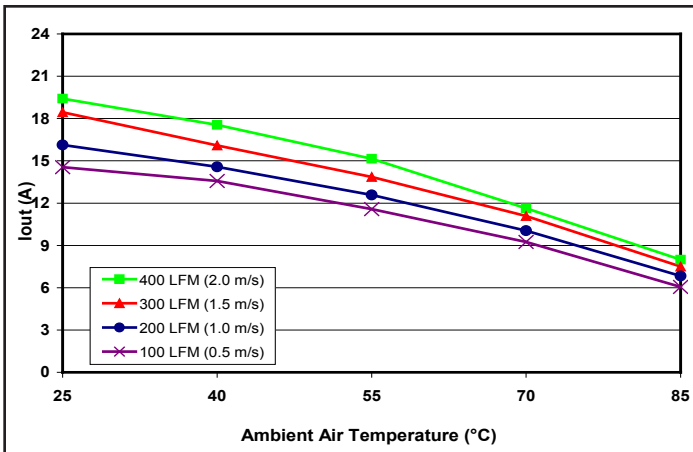

Figure 3: Thermal Derating (max output current vs. ambient air temperature) for encased converter without heatsink, at airflow rates of 100 LFM through 400 LFM. Air flows across the converter from input to output (nominal input voltage).

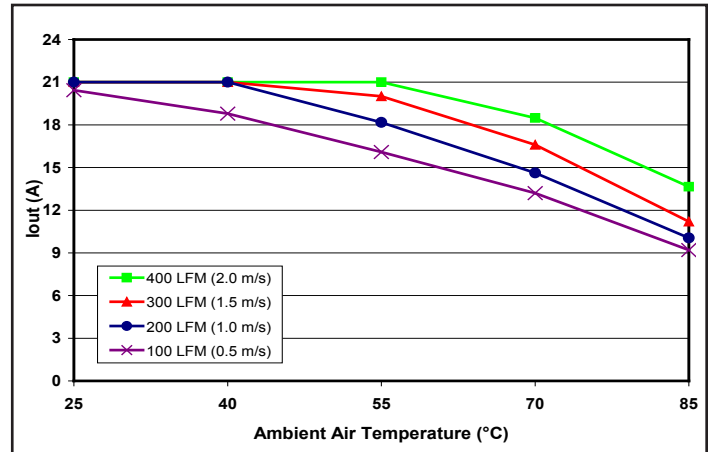

Figure 4: Thermal Derating (max output current vs. ambient air temperature) for encased converter with 1/2" heatsink, at airflow rates of 100 LFM through 400 LFM. Air flows across the converter from input to output (nominal input voltage).

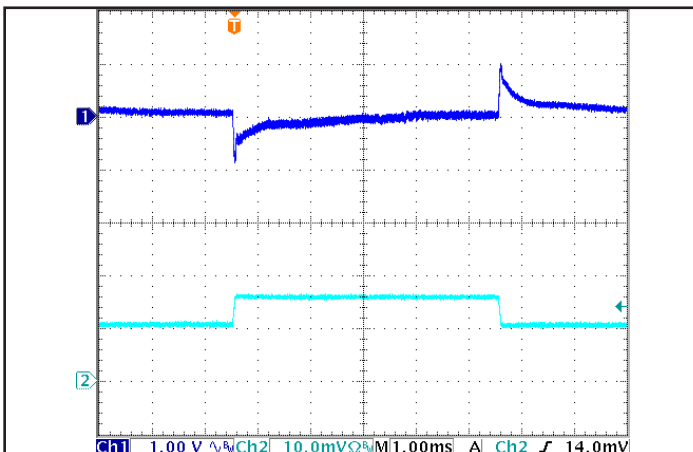

Figure 5: Output Voltage Response to Step-Change in Load Current (50%-75%-50% of Iout(max); dI/dt = 0.1A/us. Load cap: 1µF ceramic cap. Ch 1: Vout, Ch 2: Iout (10 A/div).

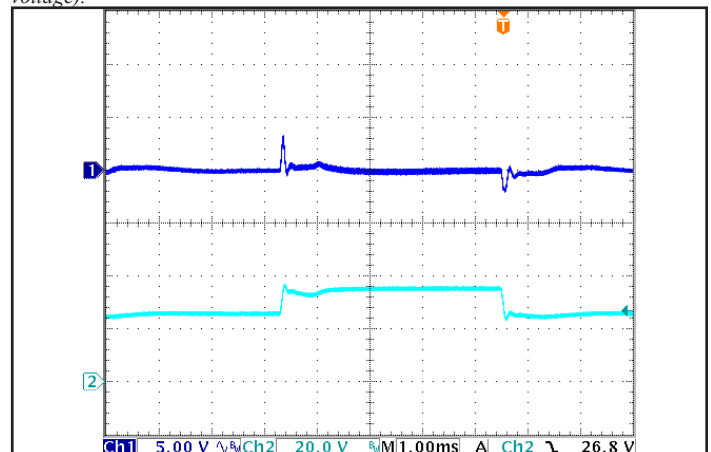

Figure 6: Output Voltage Response to Step-Change in Input Voltage (250 V/ms), at Max. load current. Load cap: 100µF electrolytic cap and 1µF ceramic cap. Ch 1: Vout, Ch 2: Vin.

IQ24280HZx18 ELECTRICAL CHARACTERISTICS (28.0 Vout)

Ta = 25 °C, airflow rate = 300 LFM, Vin = 24V dc unless otherwise noted; full operating temperature range is -40 °C to +100 °C baseplate temperature with appropriate power derating. Specifications subject to change without notice.

Parameter	Min.	Typ.	Max.	Units	Notes & Conditions
INPUT CHARACTERISTICS					
Maximum Input Current			37	A	100% Load, 18V Vin, trimmed up 10%
No-Load Input Current		300	380	mA	
Disabled Input Current		100	160	mA	
Response to Input Transient		2.5		V	See Figure 6
Input Terminal Ripple Current		500		mA	RMS
Recommended Input Fuse			40	A	Fast acting external fuse recommended
OUTPUT CHARACTERISTICS					
Output Voltage Set Point	27.54	28.00	28.39	V	
Output Voltage Regulation					See Note 3
Over Line		±0.25		%	
Over Load		±0.25		%	
Over Temperature	-700		700	mV	
Total Output Voltage Range	27.16		28.84	V	Over sample, line, load, temperature & life
Output Voltage Ripple and Noise					20 MHz bandwidth; see Note 1
Peak-to-Peak		150	300	mV	Full load
RMS		40	80	mV	Full load
Operating Output Current Range	0		18	A	Subject to thermal derating
Output DC Current-Limit Inception	19.5	21.0	22.5	A	Output voltage 10% Low
Output DC Current-Limit Shutdown Voltage		11.2		V	See Note 2
Back-Drive Current Limit while Enabled	4	5	6	A	Negative current drawn from output
Back-Drive Current Limit while Disabled	0	3	4	mA	Negative current drawn from output
Maximum Output Capacitance			5000	µF	Vout nominal at full load (resistive load)
Output Voltage during Load Current Transient					
Step Change in Output Current (0.2 A/µs)		1.5		V	50% to 75% to 50% Iout max
Settling Time		8		ms	To within 1% Vout nom
Output Voltage Trim Range	-50		20	%	Across Pins 8&4; Common Figures 3-5;
Output Voltage Remote Sense Range			10	%	Across Pins 8&4
Output Over-Voltage Protection	35.0	36.4	37.8	V	Over full temp range
EFFICIENCY					
100% Load		93		%	See Figure 1 for efficiency curve
50% Load		95		%	See Figure 1 for efficiency curve

Note 1: Output is terminated with 1 µF ceramic and 15 µF low-ESR tantalum capacitors. For applications requiring reduced output voltage ripple and noise, consult SynQor applications support (e-mail: support@synqor.com)

Note 2: If the output voltage falls below the Output DC Current Limit Shutdown Voltage for more than 50ms, then the unit will enter into hiccup mode, with a 500ms off-time

Note 3: Line and load regulation is limited by duty cycle quantization and does not indicate a shift in the internal voltage reference

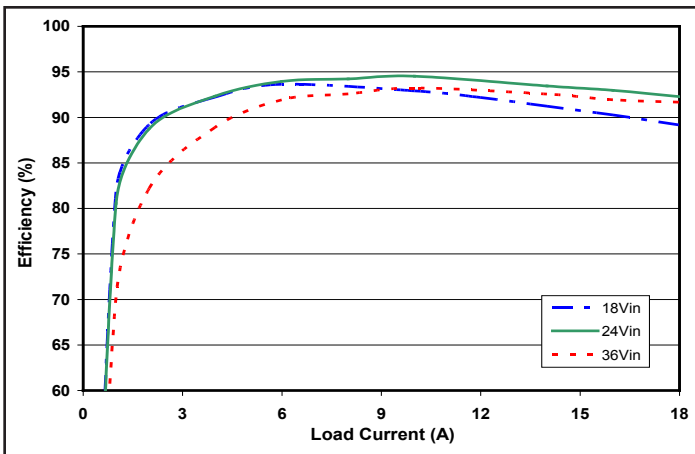

Figure 1: Efficiency at nominal output voltage vs. load current for minimum, nominal, and maximum input voltage at 25°C.

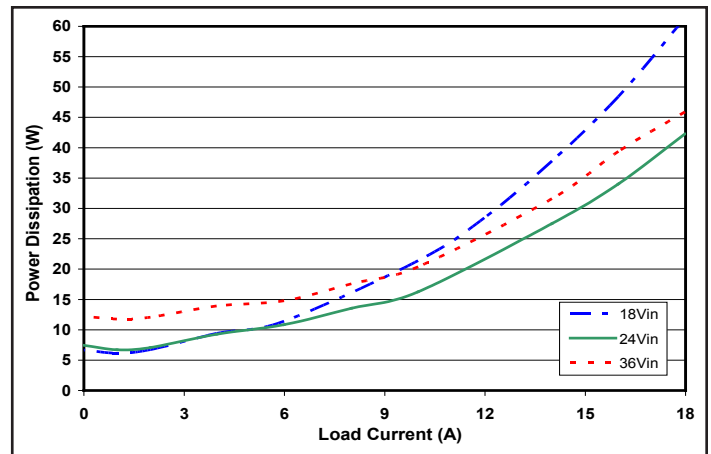

Figure 2: Power Dissipation at nominal output voltage vs. load current for minimum, nominal, and maximum input voltage at 25°C.

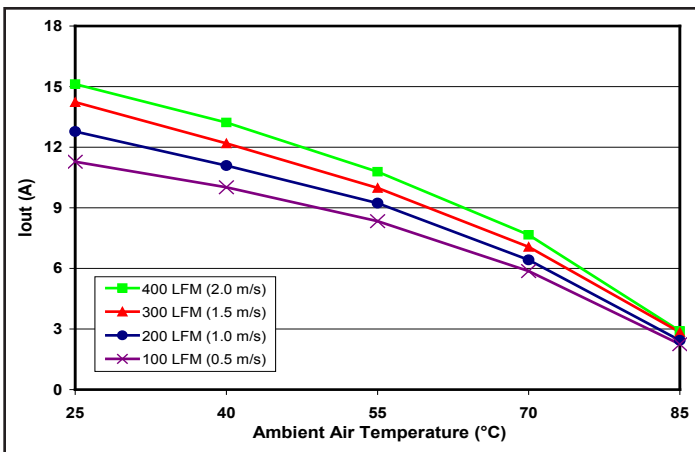

Figure 3: Thermal Derating (max output current vs. ambient air temperature) for encased converter without heatsink, at airflow rates of 100 LFM through 400 LFM. Air flows across the converter from input to output (nominal input voltage).

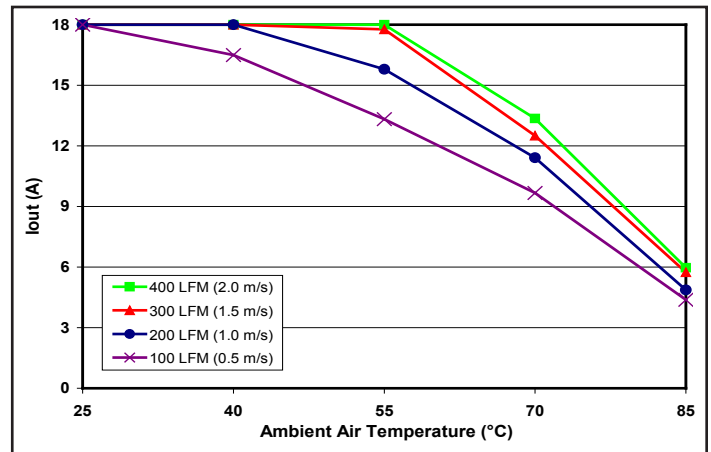

Figure 4: Thermal Derating (max output current vs. ambient air temperature) for encased converter with 1/2" heatsink, at airflow rates of 100 LFM through 400 LFM. Air flows across the converter from input to output (nominal input voltage).

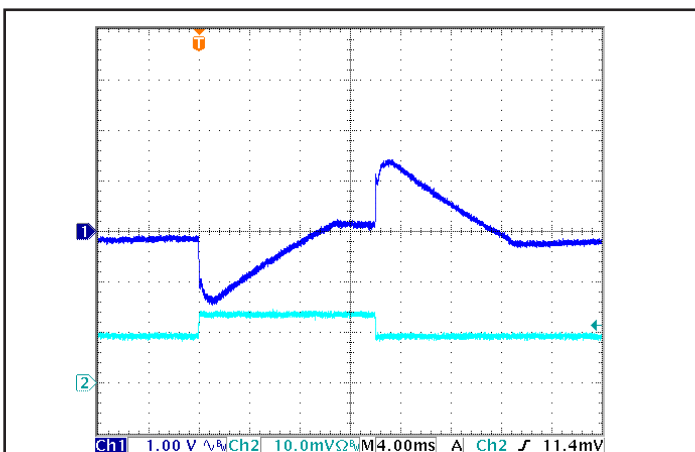

Figure 5: Output Voltage Response to Step-Change in Load Current (50%-75%-50% of I_{out}(max)); dI/dt = 0.1A/μs. Load cap: 100μF electrolytic cap and 1μF ceramic cap. Ch 1: V_{out}, Ch 2: I_{out} (10 A/div).

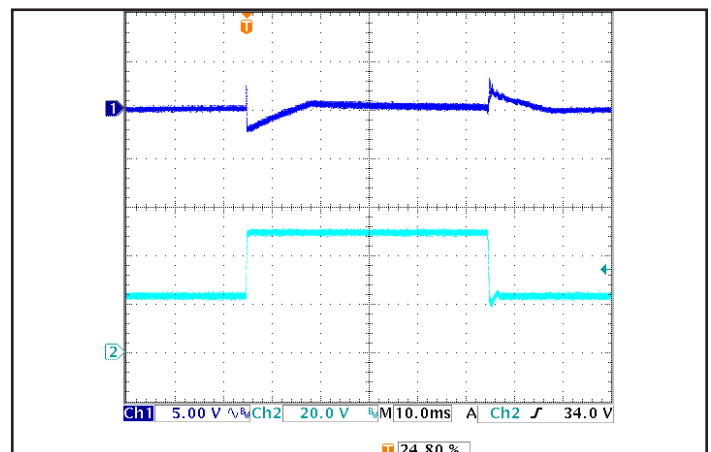

Figure 6: Output Voltage Response to Step-Change in Input Voltage (250 V/ms), at Max. load current. Load cap: 100μF electrolytic cap and 1μF ceramic cap. Ch 1: V_{out}, Ch 2: V_{in}.

IQ24400HZx13 ELECTRICAL CHARACTERISTICS (40.0 Vout)

Ta = 25 °C, airflow rate = 300 LFM, Vin = 24V dc unless otherwise noted; full operating temperature range is -40 °C to +100 °C baseplate temperature with appropriate power derating. Specifications subject to change without notice.

Parameter	Min.	Typ.	Max.	Units	Notes & Conditions
INPUT CHARACTERISTICS					
Maximum Input Current			33	A	100% Load, 18V Vin, trimmed up 10%
No-Load Input Current		280	350	mA	
Disabled Input Current		3	5	mA	
Response to Input Transient		3.5		V	See Figure 6
Input Terminal Ripple Current		400		mA	RMS
Recommended Input Fuse			40	A	Fast acting external fuse recommended
OUTPUT CHARACTERISTICS					
Output Voltage Set Point	39.34	40.00	40.56	V	
Output Voltage Regulation					See Note 3
Over Line		±0.25		%	
Over Load		±0.25		%	
Over Temperature	-1000		1000	mV	
Total Output Voltage Range	38.80		41.20	V	Over sample, line, load, temperature & life
Output Voltage Ripple and Noise					20 MHz bandwidth; see Note 1
Peak-to-Peak		100		mV	Full load
RMS		25		mV	Full load
Operating Output Current Range	0		12.5	A	Subject to thermal derating
Output DC Current-Limit Inception	13.8	15.0	16.3	A	Output voltage 10% Low
Output DC Current-Limit Shutdown Voltage		16		V	See Note 2
Back-Drive Current Limit while Enabled		3		A	Negative current drawn from output
Back-Drive Current Limit while Disabled		3	4	mA	Negative current drawn from output
Maximum Output Capacitance			1500	µF	Vout nominal at full load (resistive load)
Output Voltage during Load Current Transient					
Step Change in Output Current (0.2 A/µs)		2.2		V	50% to 75% to 50% Iout max
Settling Time		500		µs	To within 1% Vout nom
Output Voltage Trim Range	-50		10	%	Across Pins 8&4; Common Figures 3-5;
Output Voltage Remote Sense Range			10	%	Across Pins 8&4
Output Over-Voltage Protection	47.2	49.2	51.2	V	Over full temp range
EFFICIENCY					
100% Load		93		%	See Figure 1 for efficiency curve
50% Load		95		%	See Figure 1 for efficiency curve

Note 1: Output is terminated with 1 µF ceramic and 15 µF low-ESR tantalum capacitors. For applications requiring reduced output voltage ripple and noise, consult SynQor applications support (e-mail: support@synqor.com)

Note 2: If the output voltage falls below the Output DC Current Limit Shutdown Voltage for more than 50ms, then the unit will enter into hiccup mode, with a 500ms off-time

Note 3: Line and load regulation is limited by duty cycle quantization and does not indicate a shift in the internal voltage reference

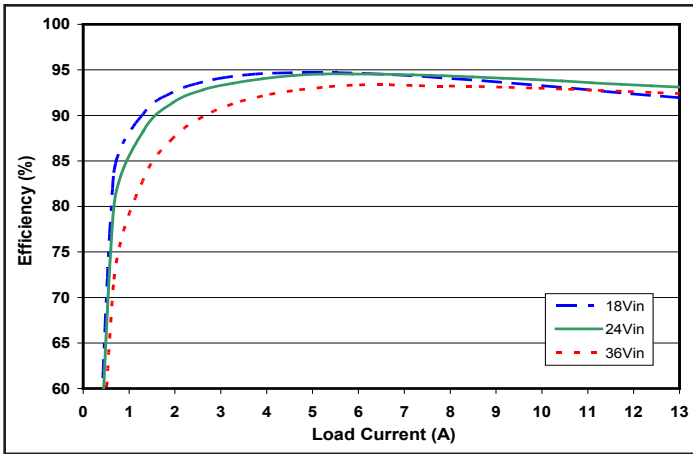

Figure 1: Efficiency at nominal output voltage vs. load current for minimum, nominal, and maximum input voltage at 25°C.

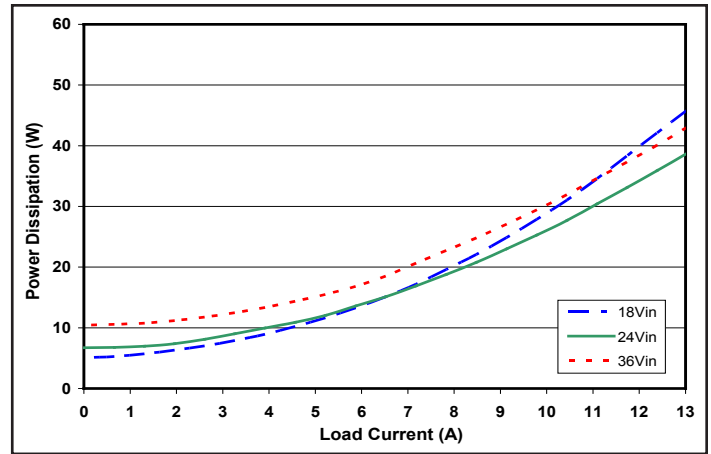

Figure 2: Power Dissipation at nominal output voltage vs. load current for minimum, nominal, and maximum input voltage at 25°C.

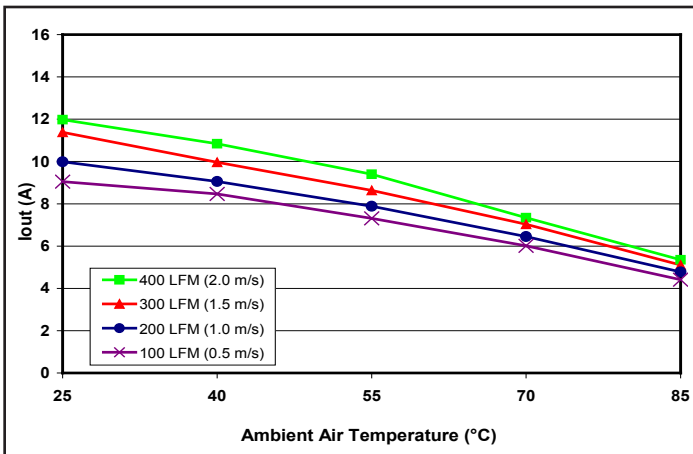

Figure 3: Thermal Derating (max output current vs. ambient air temperature) for encased converter without heatsink, at airflow rates of 100 LFM through 400 LFM. Air flows across the converter from input to output (nominal input voltage).

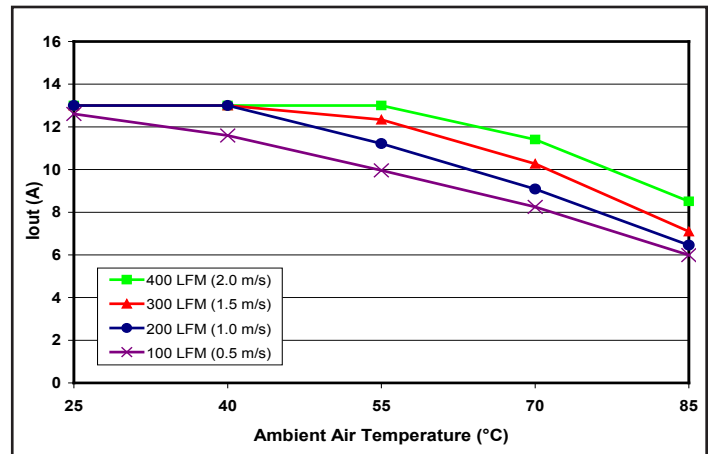

Figure 4: Thermal Derating (max output current vs. ambient air temperature) for encased converter with 1/2" heatsink, at airflow rates of 100 LFM through 400 LFM. Air flows across the converter from input to output (nominal input voltage).

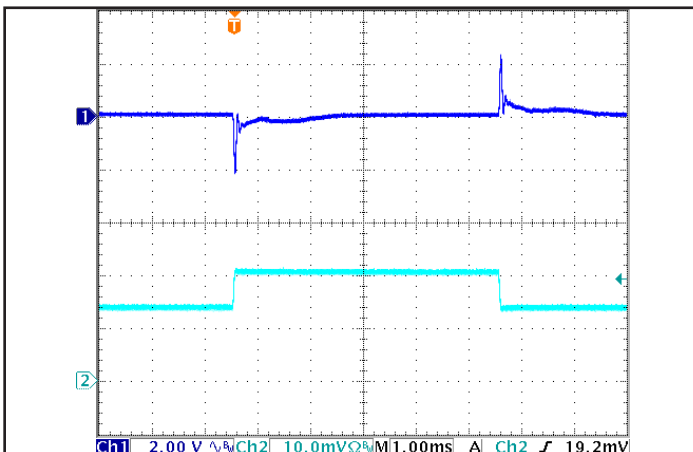

Figure 5: Output Voltage Response to Step-Change in Load Current (50%-75%-50% of Iout(max)); $di/dt = 0.1A/\mu s$. Load cap: 1 μ F ceramic cap. Ch 1: Vout, Ch 2: Iout (5 A/div).

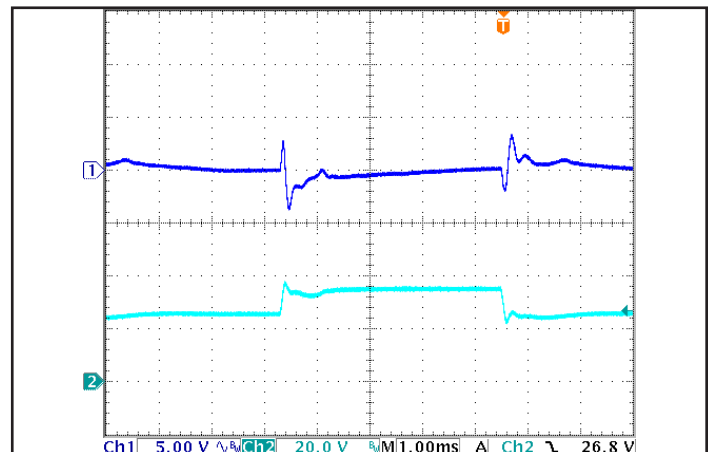

Figure 6: Output Voltage Response to Step-Change in Input Voltage (250 V/ms), at Max. load current. Load cap: 100 μ F electrolytic cap and 1 μ F ceramic cap. Ch 1: Vout, Ch 2: Vin.



Technical Specification

Input: 18-36V
Output: 50V
Current: 10A
Part No.: IQ24500HZx10

IQ24500HZx10 ELECTRICAL CHARACTERISTICS (50.0 Vout)

Ta = 25 °C, airflow rate = 300 LFM, Vin = 24V dc unless otherwise noted; full operating temperature range is -40 °C to +100 °C baseplate temperature with appropriate power derating. Specifications subject to change without notice.

Parameter	Min.	Typ.	Max.	Units	Notes & Conditions
INPUT CHARACTERISTICS					
Maximum Input Current			33	A	100% Load, 18V Vin, trimmed up 10%
No-Load Input Current		300	380	mA	
Disabled Input Current		100	160	mA	
Response to Input Transient		4		V	See Figure 6
Input Terminal Ripple Current		500		mA	RMS
Recommended Input Fuse			40	A	Fast acting external fuse recommended
OUTPUT CHARACTERISTICS					
Output Voltage Set Point	49.18	50.00	50.70	V	
Output Voltage Regulation					See Note 3
Over Line		±0.25		%	
Over Load		±0.25		%	
Over Temperature	-1250		1250	mV	
Total Output Voltage Range	48.50		51.50	V	Over sample, line, load, temperature & life
Output Voltage Ripple and Noise					20 MHz bandwidth; see Note 1
Peak-to-Peak		250	500	mV	Full load
RMS		60	120	mV	Full load
Operating Output Current Range	0		10	A	Subject to thermal derating
Output DC Current-Limit Inception	11.0	12.0	13.0	A	Output voltage 10% Low
Output DC Current-Limit Shutdown Voltage		20		V	See Note 2
Back-Drive Current Limit while Enabled	2	3	4	A	Negative current drawn from output
Back-Drive Current Limit while Disabled	0	3	7	mA	Negative current drawn from output
Maximum Output Capacitance			1000	µF	Vout nominal at full load (resistive load)
Output Voltage during Load Current Transient					
Step Change in Output Current (0.2 A/µs)		2		V	50% to 75% to 50% Iout max
Settling Time		8		ms	To within 1% Vout nom
Output Voltage Trim Range	-50		10	%	Across Pins 8&4; Common Figures 3-5;
Output Voltage Remote Sense Range			10	%	Across Pins 8&4
Output Over-Voltage Protection	56.5	59.0	61.5	V	Over full temp range
EFFICIENCY					
100% Load		94		%	See Figure 1 for efficiency curve
50% Load		95		%	See Figure 1 for efficiency curve

Note 1: Output is terminated with 1 µF ceramic capacitor. For applications requiring reduced output voltage ripple and noise, consult SynQor applications support (e-mail: support@synqor.com)

Note 2: If the output voltage falls below the Output DC Current Limit Shutdown Voltage for more than 50ms, then the unit will enter into hiccup mode, with a 500ms off-time

Note 3: Line and load regulation is limited by duty cycle quantization and does not indicate a shift in the internal voltage reference

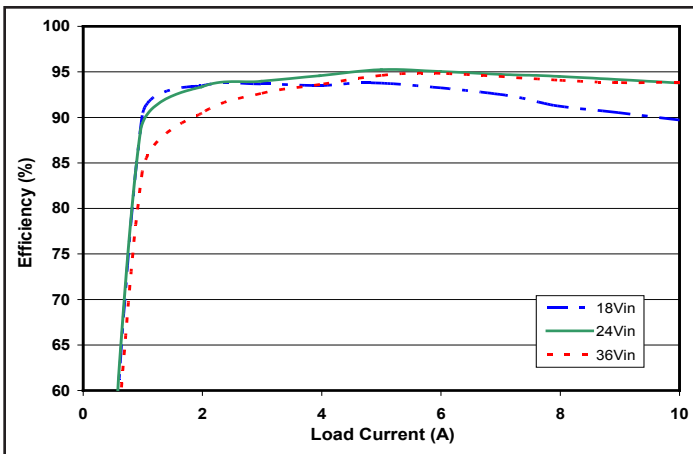

Figure 1: Efficiency at nominal output voltage vs. load current for minimum, nominal, and maximum input voltage at 25°C.

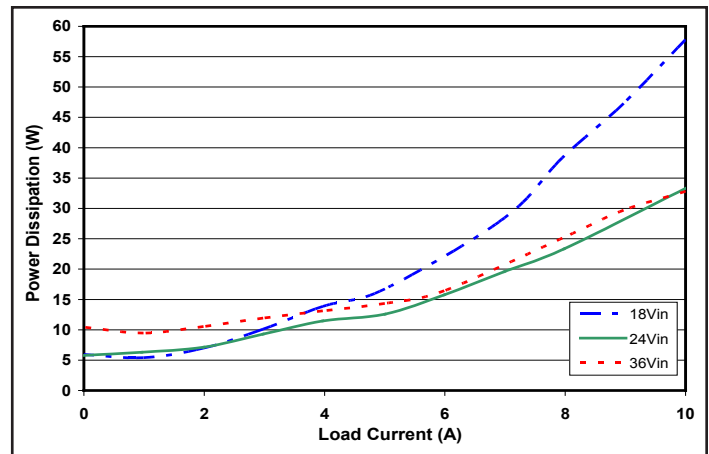

Figure 2: Power Dissipation at nominal output voltage vs. load current for minimum, nominal, and maximum input voltage at 25°C.

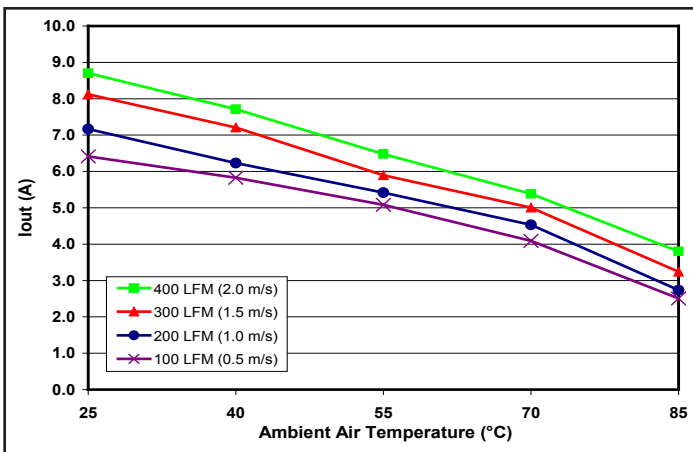

Figure 3: Thermal Derating (max output current vs. ambient air temperature) for encased converter without heatsink, at airflow rates of 100 LFM through 400 LFM. Air flows across the converter from input to output (nominal input voltage).

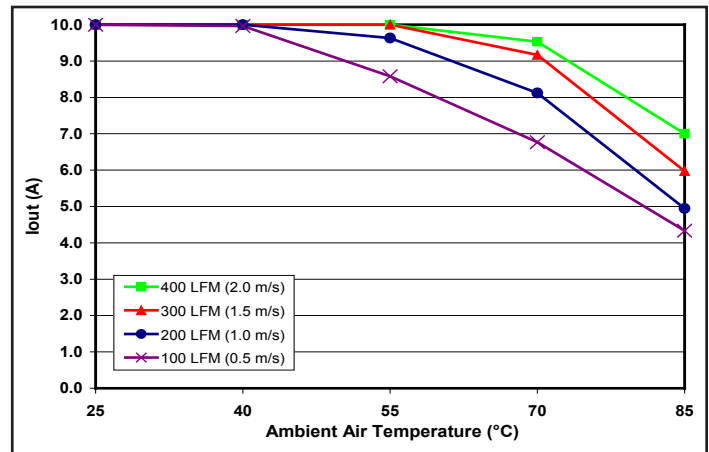

Figure 4: Thermal Derating (max output current vs. ambient air temperature) for encased converter with 1/2" heatsink, at airflow rates of 100 LFM through 400 LFM. Air flows across the converter from input to output (nominal input voltage).

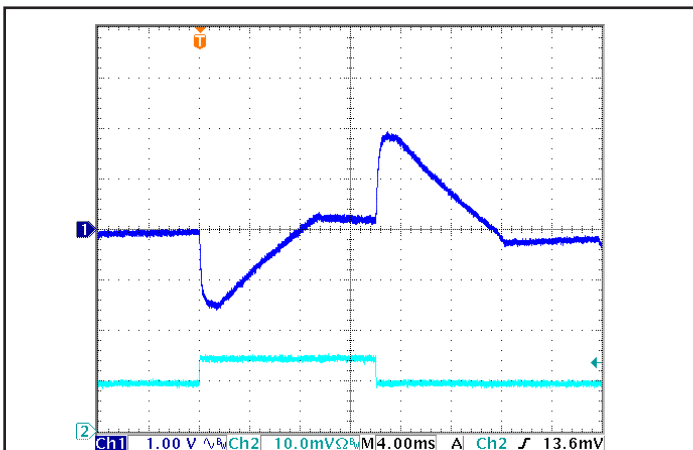

Figure 5: Output Voltage Response to Step-Change in Load Current (50%-75%-50% of I_{out}(max)); dI/dt = 0.1A/μs. Load cap: 100μF electrolytic cap and 1μF ceramic cap. Ch 1: V_{out}, Ch 2: I_{out} (5 A/div).

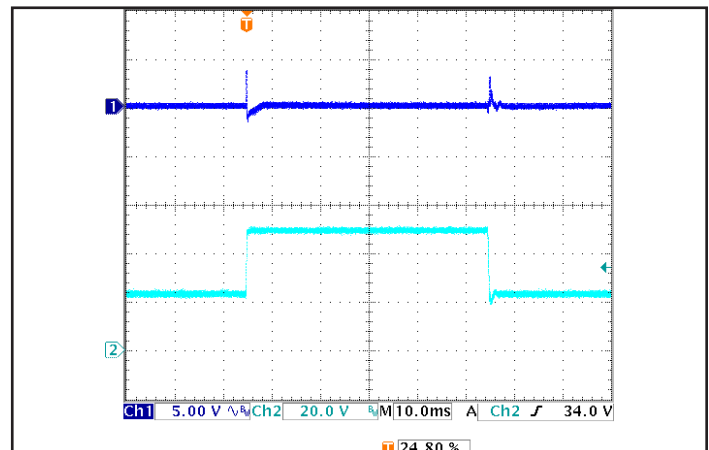

Figure 6: Output Voltage Response to Step-Change in Input Voltage (250 V/ms), at Max. load current. Load cap: 100μF electrolytic cap and 1μF ceramic cap. Ch 1: V_{out}, Ch 2: V_{in}.

BASIC OPERATION AND FEATURES

This converter series uses a two-stage power conversion topology. The first stage keeps the output voltage constant over variations in line, load, and temperature. The second stage uses a transformer to provide the functions of input/output isolation and voltage step-down to achieve the low output voltage required.

Both the first stage and the second stage switch at a fixed frequency for predictable EMI performance. Rectification of the transformer's output is accomplished with synchronous rectifiers. These devices, which are MOSFETs with a very low on-state resistance, dissipate significantly less energy than Schottky diodes, enabling the converter to achieve high efficiency.

Dissipation throughout the converter is so low that it does not require a heatsink or even a baseplate for operation in many applications; however, adding a heatsink provides improved thermal derating performance in extreme situations. To further withstand harsh environments and thermally demanding applications, certain models are available totally encased. See Ordering Information page for available thermal design options.

SynQor half-brick converters use the industry standard footprint and pin-out.

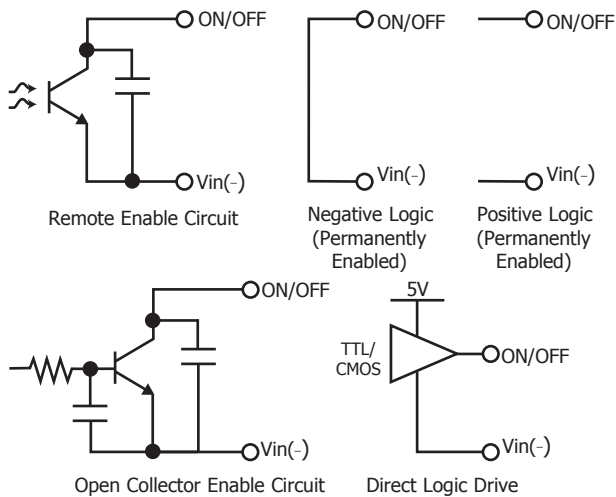

Figure A: Various Circuits for Driving the ON/OFF Pin

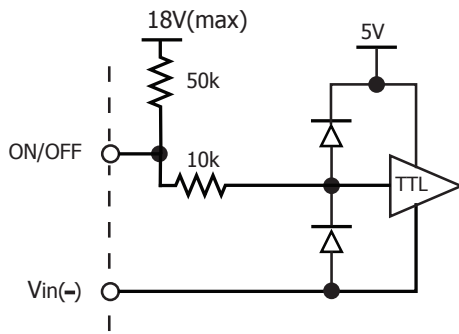

Figure B: Internal ON/OFF Pin Circuitry

CONTROL FEATURES

REMOTE ON/OFF (Pin 2): The ON/OFF input, Pin 2, permits the user to control when the converter is on or off. This input is referenced to the return terminal of the input bus, Vin(-).

In negative logic versions, the ON/OFF signal is active low (meaning that a low voltage turns the converter on). In positive logic versions, the ON/OFF input is active high (meaning that a high voltage turns the converter on). Figure A details possible circuits for driving the ON/OFF pin. Figure B is a detailed look of the internal ON/OFF circuitry. See Ordering Information page for available enable logics.

REMOTE SENSE Pins 8(+) and 6(-): The SENSE(+) and SENSE(-) inputs correct for voltage drops along the conductors that connect the converter's output pins to the load.

Pin 8 should be connected to Vout(+) and Pin 6 should be connected to Vout(-) at the point on the board where regulation is desired. If these connections are not made, the converter will deliver an output voltage that is slightly higher than its specified value.

Note: The Output Over-Voltage Protection circuit senses the voltage across the output (Pins 9 and 5) to determine when it should trigger, not the voltage across the converter's sense leads (Pins 8 and 6). Therefore, the resistive drop on the board should be small enough so that output OVP does not trigger, even during load transients.

OUTPUT VOLTAGE TRIM (Pin 7): The TRIM input permits the user to adjust the output voltage across the sense leads up or down according to the trim range specifications. SynQor uses industry standard trim equations.

To decrease the output voltage, the user should connect a resistor between Pin 7 (TRIM) and Pin 6 (SENSE(-) input). For a desired decrease of the nominal output voltage, the value of the resistor should be:

$$R_{\text{trim-down}} = \left(\frac{100\%}{\Delta\%} - 2 \right) \text{ k}\Omega$$

where

$$\Delta\% = \left| \frac{V_{\text{nominal}} - V_{\text{desired}}}{V_{\text{nominal}}} \right| \times 100\%$$

To increase the output voltage, the user should connect a resistor between Pin 7 (TRIM) and Pin 8 (SENSE(+) input). For a desired increase of the nominal output voltage, the value of the resistor should be:

$$R_{\text{trim-up}} = \frac{\left(\frac{V_{\text{nominal}}}{1.225} - 2 \right) \times V_{\text{desired}} + V_{\text{nominal}}}{V_{\text{desired}} - V_{\text{nominal}}} \text{ k}\Omega$$

The Trim Graph in Technical Features shows the relationship between the trim resistor value and Rtrim-up and Rtrim-down, showing the total range the output voltage can be trimmed up or down.

Note: The TRIM feature does not affect the voltage at which the output over-voltage protection circuit is triggered. Trimming the output voltage too high may cause the over-voltage protection circuit to engage, particularly during transients.

It is not necessary for the user to add capacitance at the TRIM pin. The node is internally filtered to eliminate noise.

Total DC Variation of Vout: For the converter to meet its full specifications, the maximum variation of the DC value of Vout, due to both trimming and remote load voltage drops, should not be greater than that specified for the output voltage trim range.

Protection Features

Input Under-Voltage Lockout (UVLO): The converter is designed to turn off when the input voltage is too low, helping to avoid an input system instability problem, which is described in more detail in the application note titled "Input System Instability" on the SynQor website. The lockout circuitry is a comparator with DC hysteresis. When the input voltage is rising, it must exceed the typical "Turn-On Voltage Threshold" value* before the converter will turn on. Once the converter is on, the input voltage must fall below the typical Turn-Off Voltage Threshold value before the converter will turn off.

Output Current Limit (OCP): If the output current exceeds the "Output DC Current Limit Inception" value*, then a fast linear current limit controller will reduce the output voltage to maintain a constant output current. If as a result, the output voltage falls below the "Output DC Current Limit Shutdown Voltage"* for more than 50 ms, then the unit will enter into hiccup mode, with a 500 ms off-time. The unit will then automatically attempt to restart.

Back-Drive Current Limit: If there is negative output current of a magnitude larger than the "Back-Drive Current Limit while Enabled" specification*, then a fast back-drive limit controller will increase the output voltage to maintain a constant output current. If this results in the output voltage exceeding the "Output Over-Voltage Protection" threshold*, then the unit will shut down.

Output Over-Voltage Limit (OVP): If the voltage across the output pins exceeds the Output Over-Voltage Protection threshold, the converter will immediately stop switching. This prevents damage to the load circuit due to 1) excessive series resistance in output current path from converter output pins to sense point, 2) a release of a short-circuit condition, or 3) a release of a current limit condition. Load capacitance determines exactly how high the output voltage will rise in response to these conditions. After 500ms the converter will automatically restart for all but the S Feature Set option, which is latching and will not restart until input power is cycled or the ON/OFF input is toggled.

Over-Temperature Shutdown (OTP): A temperature sensor on the converter senses the average temperature of the module. The thermal shutdown circuit is designed to turn the converter off when the temperature at the sensed location reaches the "Over-Temperature Shutdown" value*. It will allow the converter to turn on again when the temperature of the sensed location falls by the amount of the "Over-Temperature Shutdown Restart Hysteresis" value*.

Startup Inhibit Period: The Startup Inhibit Period ensures that the converter will remain off for approximately 500 ms when it is shut down due to a fault. This generates a 2 Hz "hiccup mode," which prevents the converter from overheating. In all, there are three ways that the converter can be shut down, initiating a Startup Inhibit Period:

- Output Over-Voltage Protection
- Current Limit
- Short Circuit Protection

* See Electrical Characteristics section.

APPLICATION CONSIDERATIONS

Input System Instability: This condition can occur because any DC-DC converter appears incrementally as a negative resistance load. A detailed application note titled "Input System Instability" is available on the SynQor website which provides an understanding of why this instability arises, and shows the preferred solution for correcting it.

Application Circuits: A typical circuit diagram, Figure C below details the input filtering and voltage trimming.

Input Filtering and External Input Capacitance: Figure D below shows the internal input filter components. This filter dramatically reduces input terminal ripple current, which otherwise could exceed the rating of an external electrolytic input capacitor. The recommended external input capacitance is specified in the Input Characteristics section of the Electrical Specifications. More detailed information is available in the application note titled "EMI Characteristics" on the SynQor website.

Output Filtering and External Output Capacitance: The internal output filter components are shown in Figure D below. This filter dramatically reduces output voltage ripple. Some minimum external output capacitance is required, as specified in the Output Characteristics area of the Electrical Characteristics section. No damage will occur without this capacitor connected, but peak output voltage ripple will be much higher.

Thermal Considerations: For baseplated and encased versions, the max operating baseplate temperature, T_B , is 100°C. Refer to the Thermal Derating Curves in the Technical Figures section to see the available output current at baseplate temperatures below 100°C.

A power derating curve can be calculated for any heatsink that is attached to the base-plate of the converter. It is only necessary to determine the thermal resistance, R_{THBA} , of the chosen heatsink between the baseplate and the ambient air for a given airflow rate. This information is usually available from the heatsink vendor. The following formula can be used to determine the maximum power the converter can dissipate for a given thermal condition if its base-plate is to be no higher than 100°C.

$$P_{diss}^{max} = \frac{100^{\circ}C - T_A}{R_{THBA}}$$

This value of maximum power dissipation can then be used in conjunction with the data shown in the Power Dissipation Curves in the Technical Figures section to determine the maximum load current (and power) that the converter can deliver in the given thermal condition.

For convenience, Thermal Derating Curves are provided in the Technical Figures section.

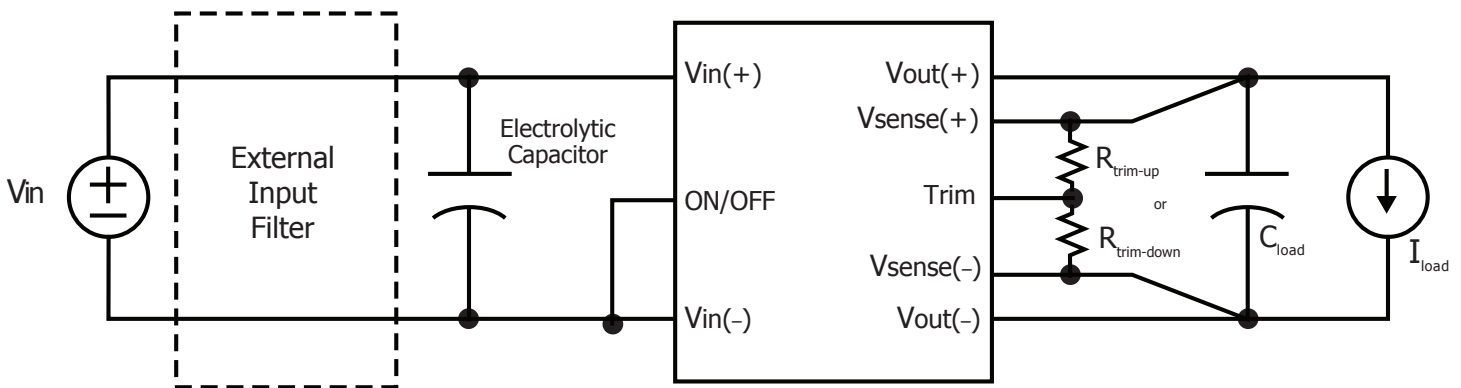

Figure C: Typical Application Circuit (negative logic unit, permanently enabled)

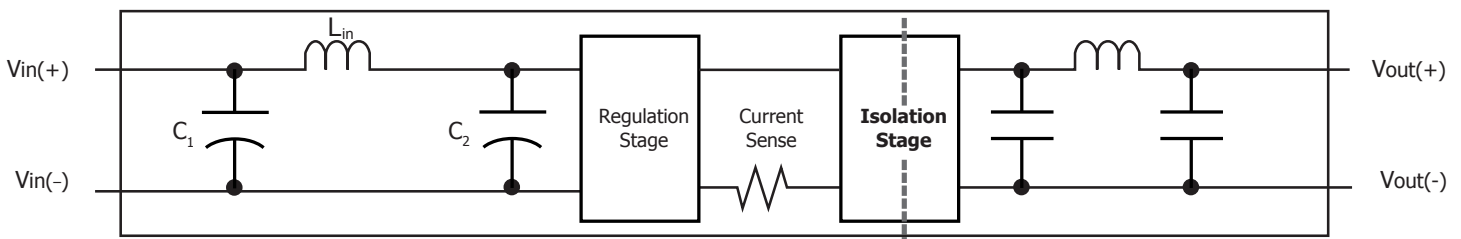

Figure D: Internal Input and Output Filter Diagram (component values listed in Electrical Characteristics section)

ACTIVE CURRENT SHARE

Overview: The full-featured option, specified by an "F" in the last character in the part number, has current sharing operation supported, achieved by adding two additional pins: SHARE(+) and SHARE(-).

Connection of Paralleled Units: Up to 100 units can be placed in parallel. In this current share architecture, one unit is dynamically chosen to act as a master, controlling all other units. It cannot be predicted which unit will become the master at any given time, so units should be wired symmetrically (see Figures E & F).

- Input power pins and output power pins should be tied together between units, preferably with wide overlapping copper planes, after any input common-mode choke.

- The SHARE(+) and SHARE(-) pins should be routed between all paralleled units as a differential pair.
- The ON/OFF pins should be connected in parallel, and rise/fall times should be kept below 2 ms.
- The SENSE(+) and SENSE(-) pins should be connected either locally at each unit or separately to a common sense point. If an output common-mode choke is used, sense lines should be connected on the module-side of the choke.
- If the TRIM pin is used, then each unit should have its own trim resistor connected locally between TRIM and SENSE(+) or SENSE(-).

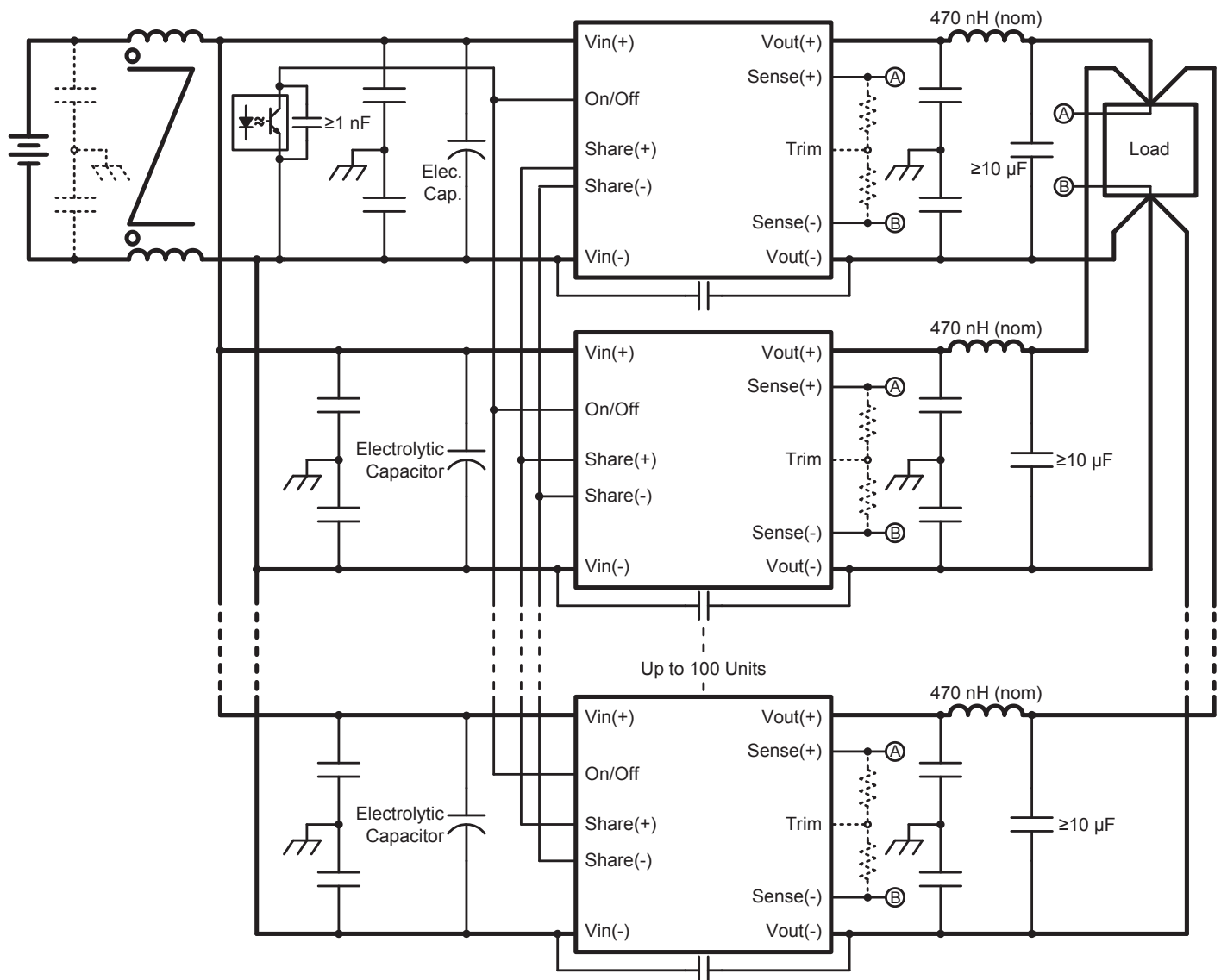

Figure E: Typical Application Circuit for Paralleling of Full-Featured Units with an Input Common-Mode Choke. If an input common-mode choke is used, Vin(-) MUST be tied together AFTER the choke for all units. 470 nH (nominal) inductor or an output common-mode choke is required for outputs >18 V. See Figure F for output common-mode choke configuration.

Automatic Configuration: The micro-controller inside each power converter unit is programmed at the factory with a unique chip number. In every other respect, each shared unit is identical and has the same orderable part number.

On initial startup (or after the master is disabled or shuts down), each unit determines the chip number of every other unit currently connected to the shared serial bus formed by the SHARE(+) and SHARE(-) pins. The unit with the highest chip number dynamically reconfigures itself from slave to master. The rest of the units (that do not have the highest chip number) become slaves.

The master unit then broadcasts its control state over the shared serial bus on a cycle-by-cycle basis. The slave units interpret and implement the control commands sent by the master, mirroring every action of the master unit.

If the master is disabled or encounters a fault condition, all units will immediately shut down, and if the master unit is unable to restart, then the unit with the next highest chip number will become master. If a slave unit is disabled or encounters a fault condition, all other units continue to run, and the slave unit can restart seamlessly.

Automatic Interleaving: The slave units automatically lock frequency with the master, and interleave the phase of their switching transitions for improved EMI performance. To obtain the phase angle relative to the master, each slave divides 360 degrees by the total number of connected units, and multiplies the result by its rank among chip numbers of connected units.

ORing Diodes placed in series with the converter outputs must also have a resistor smaller than 500 Ω placed in parallel. This resistor keeps the output voltage of a temporarily disabled slave unit consistent with the active master unit. If the output voltage of the slave unit were allowed to totally discharge, and the slave unit tried to restart, it would fail because the slave reproduces the duty cycle of the master unit, which is running in steady state and cannot repeat an output voltage soft-start.

Common-Mode Filtering must be a single primary side choke handling the inputs from all the paralleled units, or multiple chokes placed on the secondary side. This ensures a solid Vin(-) plane is maintained between units. Adding a common-mode choke at the output eliminates the need for the 470 nH inductor at the output of shared units when $V_{out} > 18$ V. If an output common-mode choke is used, sense connections must be made on the module-side of the choke.

Resonance Between Output Capacitors is Possible: When multiple higher-voltage modules are paralleled, it is possible to excite a series resonance between the output capacitors internal to the module and the parasitic inductance of the module output pins. This is especially likely at higher output voltages where the module internal capacitance is relatively small. This problem is independent of external output capacitance. For modules with an output voltage greater than 18 V, to ensure that this resonant frequency is below the switching frequency it is recommended to add a nominal 470 nH of inductance, located close to the module, in series with each converter output. There must be at least 10 μ F of capacitance per converter, located on the load-side of that inductor. The inductance could be from the leakage inductance of a secondary-side common-mode choke; in which case the output capacitor should be appropriately sized for the chosen choke. When using an output common-mode choke, the Sense lines must be connected on the module-side of the common-mode choke (see Figure F).

RS-485 Physical Layer: The internal RS-485 transceiver includes many advanced protection features for enhanced reliability:

- Current Limiting and Thermal Shutdown for Driver Overload Protection
- IEC61000 ESD Protection to +/- 16.5 kV
- Hot Plug Circuitry – SHARE(+) and SHARE(-) Outputs Remain Tri-State During Power-up/Power-down

Internal Schottky Diode Termination: Despite signaling at high speed with fast edges, external termination resistors are not necessary. Each receiver has four Schottky diodes built in, two for each line in the differential pair. These diodes clamp any ringing caused by transmission line reflections, preventing the voltage from going above about 5.5 V or below about -0.5 V. Any subsequent ringing then inherently takes place between 4.5 and 5.5 V or between -0.5 and 0.5 V. Since each receiver on the bus contains a set of clamping diodes to clamp any possible transmission line reflection, the bus does not necessarily need to be routed as a daisy-chain.

Pins SHARE(+) and SHARE(-) are referenced to Vin(-), and therefore should be routed as a differential pair near the Vin(-) plane for optimal signal integrity. The maximum difference in voltage between Vin(-) pins of all units on the share-bus should be kept within 0.3 V to prevent steady-state conduction of the termination diodes. Therefore, the Vin(-) connections to each unit must be common, preferably connected by a single copper plane.

Share Accuracy: Inside each converter micro-controller, the duty cycle is generated digitally, making for excellent duty cycle matching between connected units. Some small duty cycle mismatch is caused by (well controlled) process variations in the MOSFET gate drivers. However, the voltage difference induced by this duty cycle mismatch appears across the impedance of the entire power converter, from input to output, multiplied by two, since the differential current flows out of one converter and into another. So, a small duty cycle mismatch yields very small differential currents, which remain small even when 100 units are placed in parallel.

In other current-sharing schemes, it is common to have a current-sharing control loop in each unit. However, due to the limited bandwidth of this loop, units do not necessarily share current on startup or during transients before this loop has a chance to respond. In contrast, the current-sharing scheme used in this product has no control dynamics: control signals are transmitted fast enough that the slave units can mirror the control state of the master unit on a cycle-by-cycle basis, and the current simply shares properly, from the first switching cycle to the last.

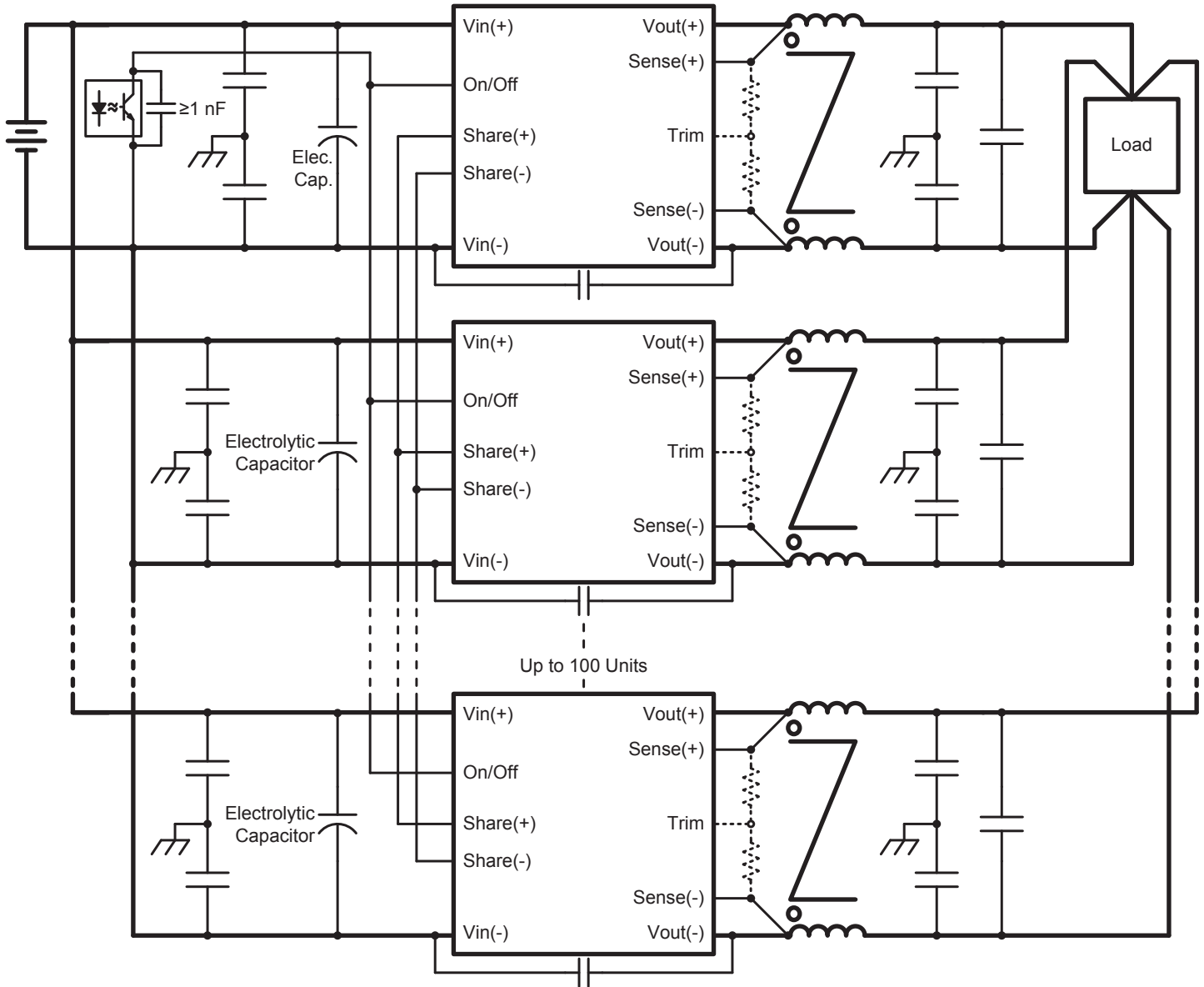

Figure F: Typical Application Circuit for Paralleling of Full-Featured Units with an Output Common-Mode Choke. When using an output common-mode choke, SENSE lines must be connected on the module-side of the choke. See Figure E for configuration with an input common-mode choke.

Standards & Qualification Testing

Parameter	Notes & Conditions
STANDARDS COMPLIANCE	
UL 60950-1/R:2011-12	Basic Insulation
CAN/CSA-C22.2 No. 60950-1/A1:2011	
EN 60950-1/A12:2011	Certified by TUV

Note: An external input fuse must always be used to meet these safety requirements. Contact SynQor for official safety certificates on new releases or download from the SynQor website.

Parameter	# Units	Test Conditions
QUALIFICATION TESTING		
Life Test	32	95% rated Vin and load, units at derating point, 1000 hours
Vibration	5	10-55 Hz sweep, 0.060" total excursion, 1 min./sweep, 120 sweeps for 3 axis
Mechanical Shock	5	100g minimum, 2 drops in x, y, and z axis
Temperature Cycling	10	-40 °C to 100 °C, unit temp. ramp 15 °C/min., 500 cycles
Power/Thermal Cycling	5	Toperating = min to max, Vin = min to max, full load, 100 cycles
Design Marginality	5	Tmin-10 °C to Tmax+10 °C, 5 °C steps, Vin = min to max, 0-105% load
Humidity	5	85 °C, 95% RH, 1000 hours, continuous Vin applied except 5 min/day
Solderability	15 pins	MIL-STD-883, method 2003
Altitude	2	70,000 feet (21 km), see Note

Note: A conductive cooling design is generally needed for high altitude applications because of naturally poor convective cooling at rare atmospheres.

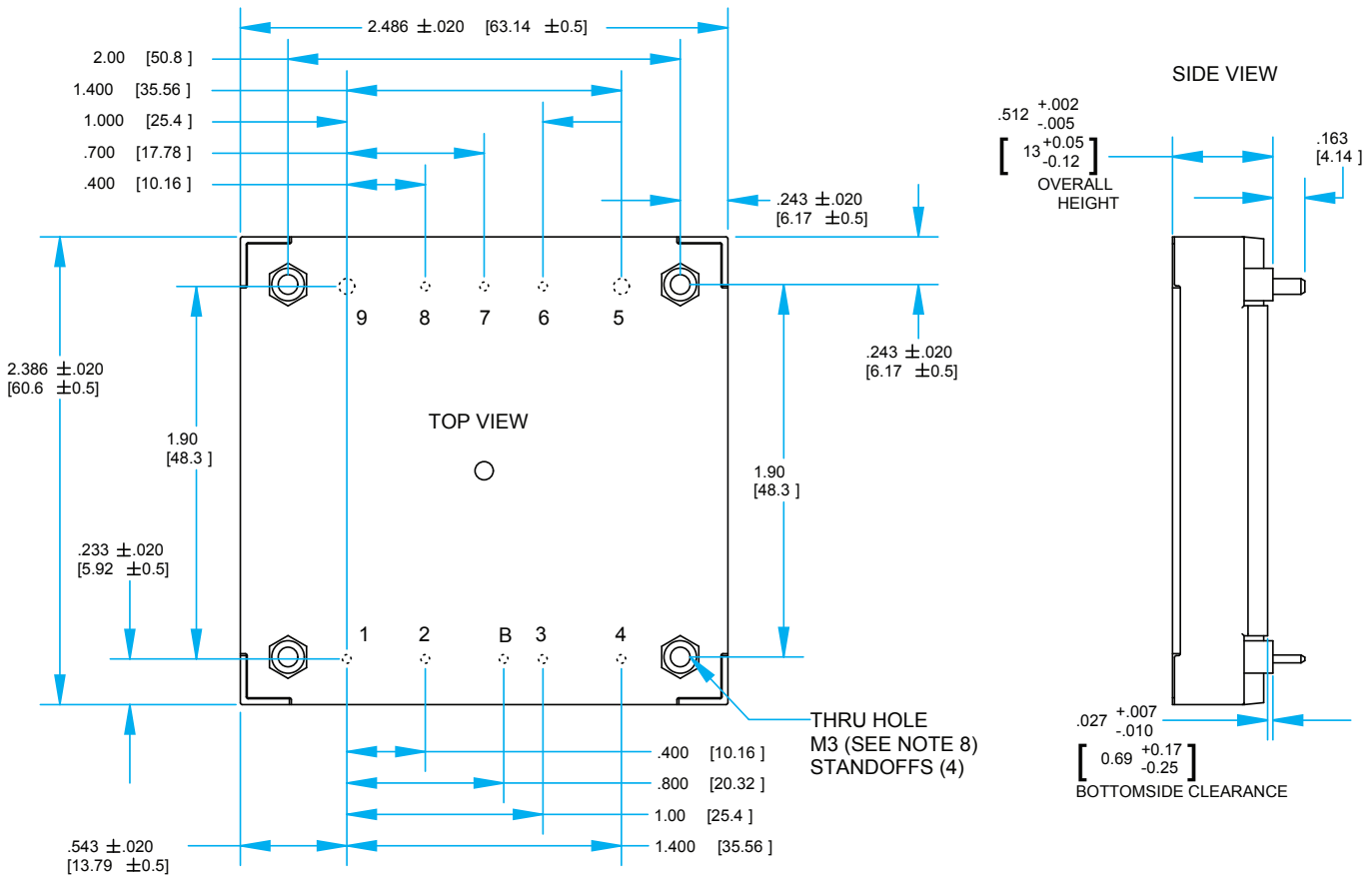

NOTES

- Applied torque per screw should not exceed 6in-lb. (0.7 Nm).
- Baseplate flatness tolerance is 0.004" (.10 mm) TIR for surface.
- Pins 1-4, 6-8, and B are 0.040" (1.02mm) diameter, with 0.080" (2.03mm) diameter standoff shoulders.
- Pins 5 and 9 are 0.080" (2.03 mm) diameter with 0.125" (3.18 mm) diameter standoff shoulders.
- All Pins: Material - Copper Alloy; Finish - Matte Tin over Nickel plate
- Undimensioned components are shown for visual reference only.
- Weight: 4.9 oz (139 g)
- Threaded and Non-Threaded options available
- All dimensions in inches (mm).
- Tolerances:
x.xx +/-0.02 in. (x.x +/-0.5mm)
x.xxx +/-0.010 in. (x.xx +/-0.25mm)
unless otherwise noted.
- Workmanship: Meets or exceeds IPC-A-610C Class II

PIN DESIGNATIONS

Pin	Name	Function
1	Vin(+)	Positive input voltage
2	ON/OFF	TTL input to turn converter on and off, referenced to Vin(-), with internal pull up.
B	SHARE(+)	Active current share differential pair (See note 4)
3	SHARE(-)	
4	Vin(-)	Negative input voltage
5	Vout(-)	Negative output voltage
6	SENSE(-)	Negative remote sense (See note 1)
7	TRIM	Output voltage trim (See note 2)
8	SENSE(+)	Positive remote sense (See note 3)
9	Vout(+)	Positive output voltage

Notes:

- SENSE(-) should be connected to Vout(-) either remotely or at the converter.
- Leave TRIM pin open for nominal output voltage.
- SENSE(+) should be connected to Vout(+) either remotely or at the converter.
- Full-Featured option only. Pin 3 and Pin B not populated on standard model.

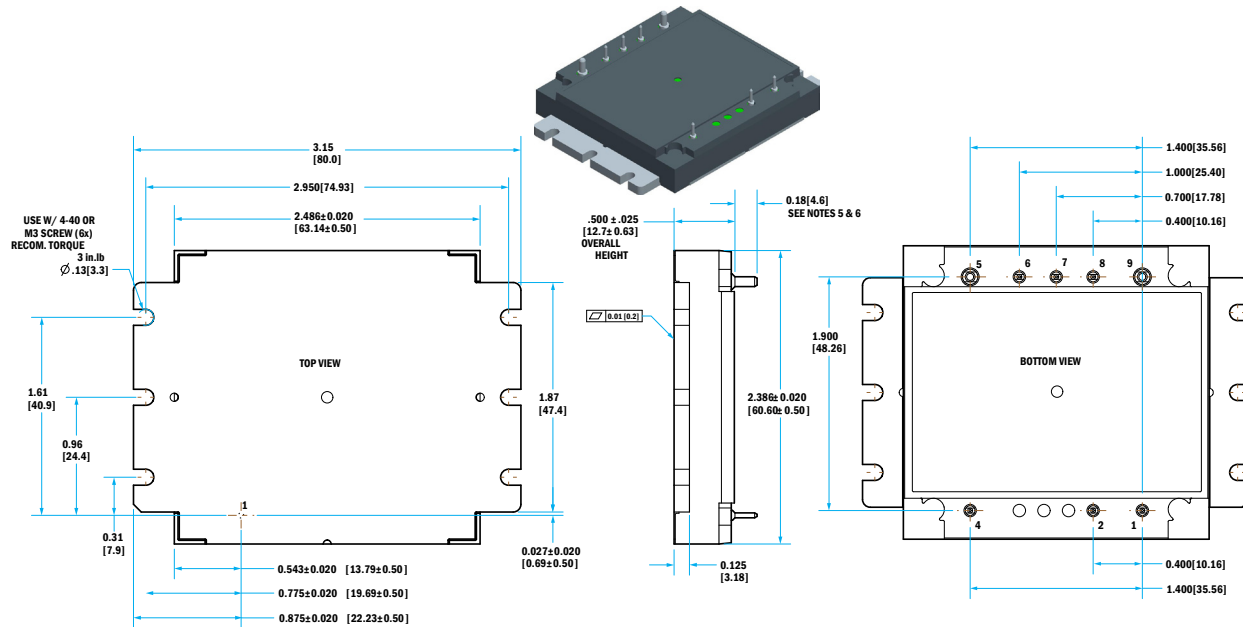

NOTES

- Applied torque per screw should not exceed 5in-lb. (0.7 Nm) (3in-lb. recommended).
- Baseplate flatness tolerance is 0.01" (.25 mm) TIR for surface.
- Pins 1-4, 6-8 and B are 0.040" (1.02mm) diameter, with 0.080" (2.03mm) diameter standoff shoulders.
- Pins 5 and 9 are 0.080" (2.03 mm) diameter with 0.125" (3.18 mm) diameter standoff shoulders.
- All Pins: Material - Copper Alloy; Finish - Matte Tin over Nickel plate
- Undimensioned components are shown for visual reference only.
- Weight: 4.8oz (137g)
- All dimensions in inches (mm).
Tolerances:
x.xx +/-0.02 in. (x.x +/-0.5mm)
x.xxx +/-0.010 in. (x.xx +/-0.25mm)
unless otherwise noted.
- Workmanship: Meets or exceeds IPC-A-610C Class II

PIN DESIGNATIONS

Pin	Name	Function
1	Vin(+)	Positive input voltage
2	ON/OFF	TTL input to turn converter on and off, referenced to Vin(-), with internal pull up.
B	SHARE(+)	Active current share differential pair (See note 4)
3	SHARE(-)	
4	Vin(-)	Negative input voltage
5	Vout(-)	Negative output voltage
6	SENSE(-)	Negative remote sense (See note 1)
7	TRIM	Output voltage trim (See note 2)
8	SENSE(+)	Positive remote sense (See note 3)
9	Vout(+)	Positive output voltage

Notes:

- SENSE(-) should be connected to Vout(-) either remotely or at the converter.
- Leave TRIM pin open for nominal output voltage.
- SENSE(+) should be connected to Vout(+) either remotely or at the converter.
- Full-Featured option only. Pin 3 and Pin B not populated on standard model.

PART NUMBERING SYSTEM

The part numbering system for SynQor's dc-dc converters follows the format shown in the example below.

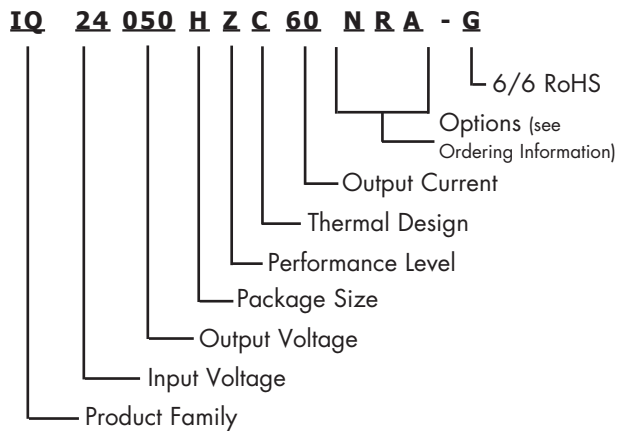

The first 12 characters comprise the base part number and the last 3 characters indicate available options. The "-G" suffix indicates 6/6 RoHS compliance.

Application Notes

A variety of application notes and technical white papers can be downloaded in pdf format from our [website](#).

RoHS Compliance: The EU led RoHS (Restriction of Hazardous Substances) Directive bans the use of Lead, Cadmium, Hexavalent Chromium, Mercury, Polybrominated Biphenyls (PBB), and Polybrominated Diphenyl Ether (PBDE) in Electrical and Electronic Equipment. This SynQor product is 6/6 RoHS compliant. For more information please refer to SynQor's RoHS addendum available at our [RoHS Compliance / Lead Free Initiative web page](#) or e-mail us at rohs@synqor.com.

Contact SynQor for further information and to order:

Phone: 978-849-0600
Toll Free: 888-567-9596
Fax: 978-849-0602
E-mail: power@synqor.com
Web: www.synqor.com
Address: 155 Swanson Road
 Boxborough, MA 01719
 USA

ORDERING INFORMATION

The tables below show the valid model numbers and ordering options for converters in this product family. When ordering SynQor converters, please ensure that you use the complete 15 character part number consisting of the 12 character base part number and the additional characters for options. Add "-G" to the model number for 6/6 RoHS compliance.

Model Number	Input Voltage	Output Voltage	Max Output Current
IQ24050HZw60xyz	18-36	5.0 V	60 A
IQ24120HZw42xyz	18-36	12 V	42 A
IQ24150HZw34xyz	18-36	15 V	34 A
IQ24240HZw21xyz	18-36	24 V	21 A
IQ24280HZw18xyz	18-36	28 V	18 A
IQ24400HZw13xyz	18-36	40 V	12.5 A
IQ24500HZw10xyz	18-36	50 V	10 A

The following options must be included in place of the **wxyz** spaces in the model numbers listed above.

Options Description			
Thermal Design	Enable Logic	Pin Style	Feature Set
C - Encased D - Encased with Non-Threaded Baseplate V - Encased with Flanged Baseplate	N - Negative	R - 0.180"	A - Standard w/ Auto-Recovery OVP F - Full-Feature S - Standard w/ Latching OVP

Not all combinations make valid part numbers, please contact SynQor for availability. See the [Product Summary web page](#) for more options.

PATENTS

SynQor holds the following U.S. patents, one or more of which apply to each product listed in this document. Additional patent applications may be pending or filed in the future.

5,999,417	6,222,742	6,545,890	6,577,109	6,594,159	6,731,520
6,894,468	6,896,526	6,927,987	7,050,309	7,072,190	7,085,146
7,119,524	7,269,034	7,272,021	7,272,023	7,558,083	7,564,702
7,765,687	7,787,261	8,023,290	8,149,597	8,493,751	

Warranty

SynQor offers a two (2) year limited warranty. Complete warranty information is listed on our website or is available upon request from SynQor.

Information furnished by SynQor is believed to be accurate and reliable. However, no responsibility is assumed by SynQor for its use, nor for any infringements of patents or other rights of third parties which may result from its use. No license is granted by implication or otherwise under any patent or patent rights of SynQor.