

FEATURES:

- 64K x 8-bit OTP EPROM organization
- RAD-PAK[®] radiation-hardened against natural space radiation
- Total dose hardness:
 - > 100 Krad (Si), depending upon space mission
- Excellent Single Event Effects:
 - SEL_{TH} > 80 MeV/mg/cm²
 - SEU_{TH} > 80 MeV/mg/cm²
- Package:
 - 32 pin RAD-PAK[®] flat pack
 - 32 pin RAD-PAK[®] DIP
- Fast access time:
 - 120, 150, 200 ns (max)
- Low power dissipation:
 - Active mode: 100 mW/MHz (typ)
 - Standby mode: 10 μW (typ)
- Programming power supply:
 - V_{pp} = 12.5 V + 0.3 V
- One-time programmable
- Pin arrangement
 - JEDEC standard byte-wide EPROM
 - Flash memory and mask ROM compatible

DESCRIPTION:

Maxwell Technologies' 27C512T high density 512-Kilobit one-time programmable electrically programmable read only memory microcircuit features a greater than 100 krad (Si) total dose tolerance, depending upon space mission. The 27C512T features fast address times and low power dissipation. The 27C512T offers high speed programming using page programming mode.

Maxwell Technologies' patented RAD-PAK[®] packaging technology incorporates radiation shielding in the microcircuit package. It eliminates the need for box shielding while providing the required radiation shielding for a lifetime in orbit or space mission. In a GEO orbit, RAD-PAK provides greater than 100 krad (Si) radiation dose tolerance. This product is available with screening up to Class S.

TABLE 1. 27C512T PINOUT DESCRIPTION

PIN	SYMBOL	DESCRIPTION
1	V_{PP}	Programming Voltage
2, 30	NC	Not connected
12-5, 27, 26, 23, 25, 4, 28, 29, 3	A0-A15	Address Enable
22	\overline{CE}	Chip Enable
24	\overline{OE}	Output Enable
13-15, 17-21	I/O0 - I/O7	Data Input/Output
16	GND	Ground
31	\overline{PGM}	Program
32	V_{CC}	+5V Power Supply

TABLE 2. 27C512T ABSOLUTE MAXIMUM RATINGS

PARAMETER	SYMBOL	MIN	MAX	UNIT
Supply Voltage ¹	V_{CC}	-0.6	+7.0	V
Programming Voltage ¹	V_{PP}	-0.6	+13.5	V
All Input and Output Voltage ^{1,2}	V_{IN}, V_{OUT}	-0.6	+7.0	V
A9 and OE Voltage	V_{ID}	-0.6	13.0	V
Operating Temperature Range	T_{OPR}	-55	+125	°C
Storage Temperature Range	T_{STG}	-65	+125	°C

1. Relative to V_{SS} .

2. V_{IN} , V_{OUT} , and V_{ID} min = -1.0V for pulse width \leq 20 ns.

TABLE 3. DELTA LIMITS

PARAMETER	VARIATION
I_{SB}	$\pm 10\%$
I_{CC1}	$\pm 10\%$
I_{CC2}	$\pm 10\%$
I_{CC3}	$\pm 10\%$

TABLE 4. 27C512T RECOMMENDED OPERATING CONDITIONS

PARAMETER	SYMBOL	MIN	MAX	UNITS
Supply Voltage	V_{CC}	4.5	5.5	V
Input Voltage	V_{IL}	-0.3 ¹	0.8	V
	V_{IH}	2.2	$V_{CC} + 1$ ²	
Thermal Impedance — DIP Package	Θ_{JC}	--	1.26	°C/W
Thermal Impedance — Flat Package	Θ_{JC}	--	1.27	°C/W
Operating Temperature Range	T_{OPR}	-55	+125	°C

1. V_{IL} min = -1.0V for pulse width \leq 50 ns.
2. V_{IH} max = $V_{CC} + 1.5V$ for pulse width \leq 20 ns.

TABLE 5. 27C512T CAPACITANCE ¹

PARAMETER	SYMBOL	MIN	MAX	UNIT
Input Capacitance	C_{IN}	--	10	pF
Output Capacitance	C_{OUT}	--	15	pF

1. Guaranteed by design.

TABLE 6. 27C512T DC ELECTRICAL CHARACTERISTICS FOR READ OPERATION

($V_{CC} = 5V \pm 10\%$, $V_{PP} = V_{SS}$ TO V_{CC} , $T_A = -55$ TO $+125$ °C, UNLESS OTHERWISE SPECIFIED)

PARAMETER	TEST CONDITION	SYMBOL	SUBGROUPS	MIN	TYP	MAX	UNIT
Input Leakage Current	$V_{IN} = 5.5 V$	I_{LI}	1, 2, 3	--	--	2	μA
Output Leakage Current	$V_{OUT} = 5.5 V/0.45 V$	I_{LO}	1, 2, 3	--	--	2	μA
Standby V_{CC} Current	$\overline{CE} = V_{IH}$	I_{SB}	1, 2, 3	--	--	1	mA
Operating V_{CC} Current	$I_{OUT} = 0 mA$, $\overline{CE} = V_{IL}$	I_{CC1}	1, 2, 3	--	--	30	mA
	$I_{OUT} = 0 mA$, $f = 5 MHz$	I_{CC2}	1, 2, 3	--	--	30	
	$I_{OUT} = 0 mA$, $f = 10 MHz$	I_{CC3}	1, 2, 3	--	--	50	
V_{PP} Current	$V_{PP} = 5.5 V$	I_{PP1}	1, 2, 3	--	1	20	μA
Input Voltage		V_{IH}	1, 2, 3	2.2	--	--	V
		V_{IL}	1, 2, 3	--		0.8	
Output Voltage	$I_{OH} = -400 \mu A$	V_{OH}	1, 2, 3	2.4	--	--	V
	$I_{OL} = 2.1 mA$	V_{OL}	1, 2, 3	--	--	0.45	

TABLE 8. 27C512T AC ELECTRICAL CHARACTERISTICS FOR PROGRAMMING OPERATION^{1,2} $(V_{CC} = 6.0V \pm 0.25V, V_{PP} = 12.5V + 0.3V, T_A = 25^\circ C)$

PARAMETER	SYMBOL	SUBGROUPS	MIN	TYP	MAX	UNIT
Address Setup Time	t_{AS}	9, 10, 11	2	--	--	μs
Address Hold Time	t_{AH}	9, 10, 11	0	--	--	μs
Data Setup Time	t_{DS}	9, 10, 11	2	--	--	μs
Data Hold Time	t_{DH}	9, 10, 11	2	--	--	μs
V_{PP} Setup Time	t_{VPS}	9, 10, 11	2	--	--	μs
V_{CC} Setup Time	t_{VCS}	9, 10, 11	2	--	--	μs
Output Enable Setup Time	t_{OES}	9, 10, 11	2	--	--	μs
Output Disable Time	t_{DF}^3	9, 10, 11	0	--	130	ns
\overline{CE} Initial Programming Pulse Width	t_{PW}	9, 10, 11	0.19	0.20	0.21	ms
\overline{CE} Overprogramming Pulse Width	t_{OPW}	9, 10, 11	0.19	--	5.25	ms
Output Enable Hold Time	t_{OEH}	9, 10, 11	2	--	--	μs
V_{PP} Recovery Time	t_{VR}	9, 10, 11	2	--	--	μs
Data Valid from Chip Enable	t_{DV}	9, 10, 11	1	--	--	μs

- t_{DF} is defined as the time at which the output becomes an open circuit and data is no longer driven.
- AC electrical parameters for programming operations are not tested. These are guaranteed by design.
- Test Conditions:
 - Input pulse levels $0.45V/2.4V$
 - Input rise and fall times $< 20\text{ ns}$
 - Referenced levels for measuring timing $0.8V/2.0V$

TABLE 9. 27C512T DC ELECTRICAL CHARACTERISTICS FOR PROGRAMMING OPERATIONS^{1,2,3,4} $(V_{CC} = 6.0V \pm 0.25V, V_{PP} = 12.5V + 0.3V, T_A = 25^\circ C)$

PARAMETER	TEST CONDITION	SYMBOL	SUBGROUPS	MIN	MAX	UNIT
Input Leakage Current	$V_{IN}=0V$ to V_{CC}	I_{LI}	1, 2, 3	--	2	μA
Operating V_{CC} Current		I_{CC}	1, 2, 3	--	30	mA
Operating V_{PP} Current	$\overline{CE}=\overline{PGM}=V_{IL}$	I_{PP}	1, 2, 3	--	40	mA
Input Voltage ⁵		V_{IH}	1, 2, 3	2.2	$V_{CC}+0.5^6$	V
		V_{IL}	1, 2, 3	-0.1 ⁷	0.8	
Output Voltage	$I_{OH}=-400\mu A$	V_{OH}	1, 2, 3	2.4	--	V
	$I_{OH}= 2.1mA$	V_{OL}	1, 2, 3	--	0.45	

- V_{CC} must be applied before V_{PP} and removed after V_{PP} .
- V_{PP} must not exceed 13V, including overshoot.
- Do not change V_{PP} from V_{IL} to 12.5V or 12.5V to V_{IL} when $\overline{CE} = \text{low}$.
- DC electrical parameters for programming operations are not tested. These are guaranteed by design.
- Device reliability may be adversely affected if the device is installed or removed while $V_{PP} = 12.5V$.

6. If V_{IH} is over the specified maximum value, programming operation can not be guaranteed.
 7. V_{IL} min = -0.6V for pulse width ≤ 20 ns.

TABLE 10. 27C512T MODE SELECTION

MODE	V_{PP}	V_{CC}	\overline{CE}	\overline{OE}	\overline{PGM}	A_9	I/O
Read	V_{CC}	V_{CC}	V_{IL}	V_{IL}	V_{IH}	X ¹	D_{OUT}
Output Disable	V_{CC}	V_{CC}	V_{IL}	V_{IH}	V_{IH}	X	High-Z
Standby	V_{CC}	V_{CC}	V_{IH}	X	X	X	High-Z
Program	V_{PP}	V_{CC}	V_{IL}	V_{IH}	V_{IL}	X	D_{IN}
Program Verify	V_{PP}	V_{CC}	V_{IL}	V_{IL}	V_{IH}	X	D_{OUT}
Page Data Latch	V_{PP}	V_{CC}	V_{IH}	V_{IL}	V_{IH}	X	D_{IN}
Page Program	V_{PP}	V_{CC}	V_{IH}	V_{IH}	V_{IL}	X	High-Z
Program Inhibit	V_{CC}	V_{CC}	V_{IL}	V_{IL}	V_{IL}	X	High-Z
	V_{PP}	V_{CC}	V_{IL}	V_{IH}	V_{IH}	X	High-Z
	V_{PP}	V_{CC}	V_{IH}	V_{IL}	V_{IL}	X	High-Z
	V_{PP}	V_{CC}	V_{IH}	V_{IH}	V_{IH}	X	High-Z
Identifier	V_{CC}	V_{CC}	V_{IL}	V_{IL}	V_{IH}	V_H^2	ID

1. X = Don't care.
 2. $11.5V < V_H < 12.5V$.

FIGURE 1. READ TIMING WAVEFORM

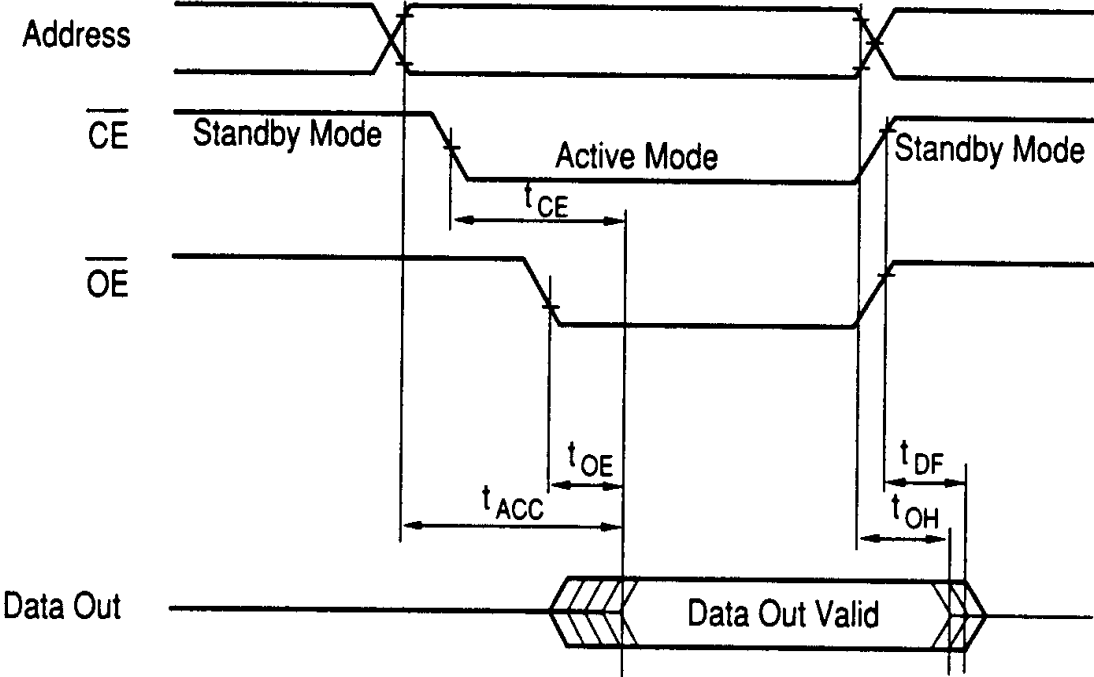

FIGURE 2. PAGE PROGRAMMING FLOWCHART

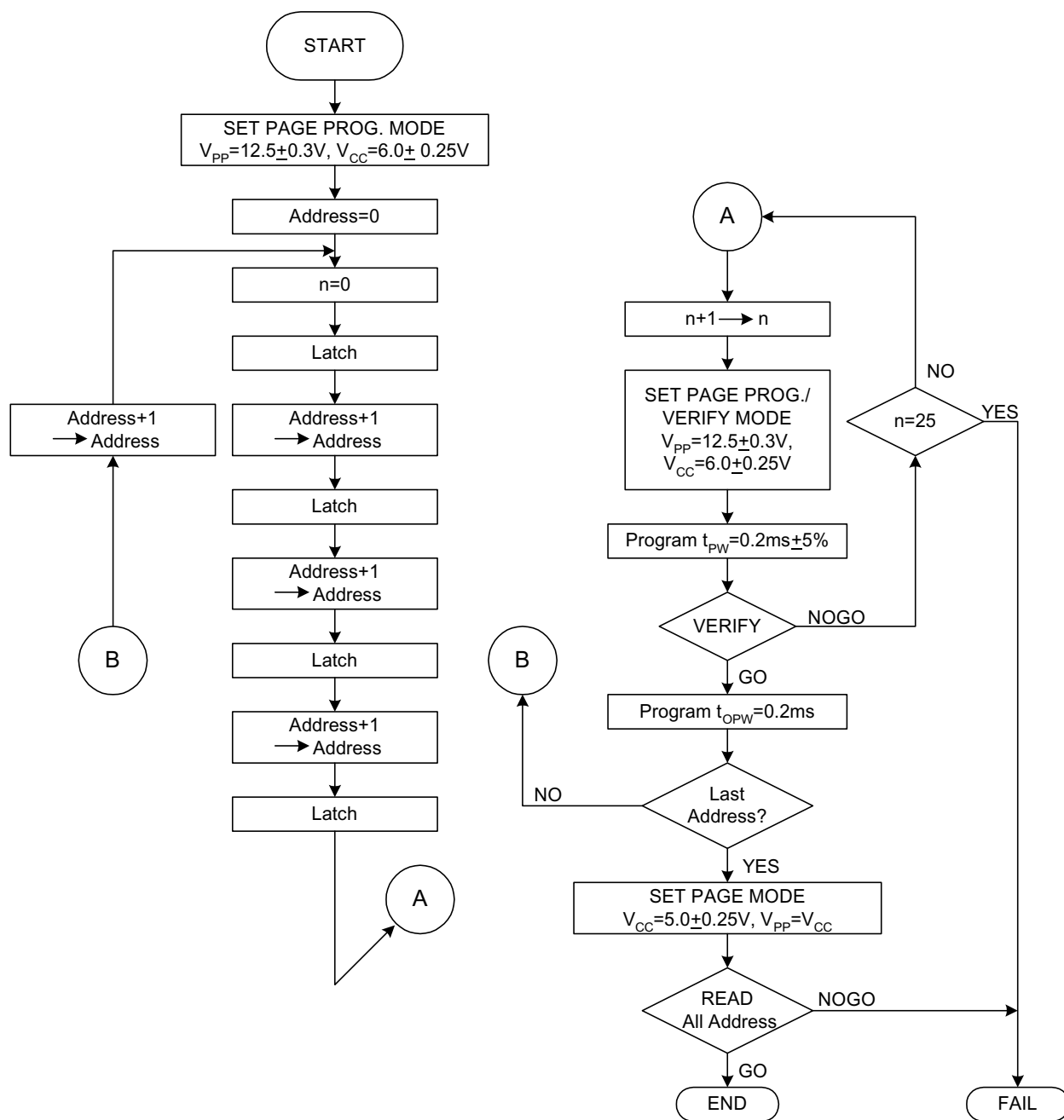

FIGURE 3. PAGE PROGRAMMING TIMING WAVEFORM

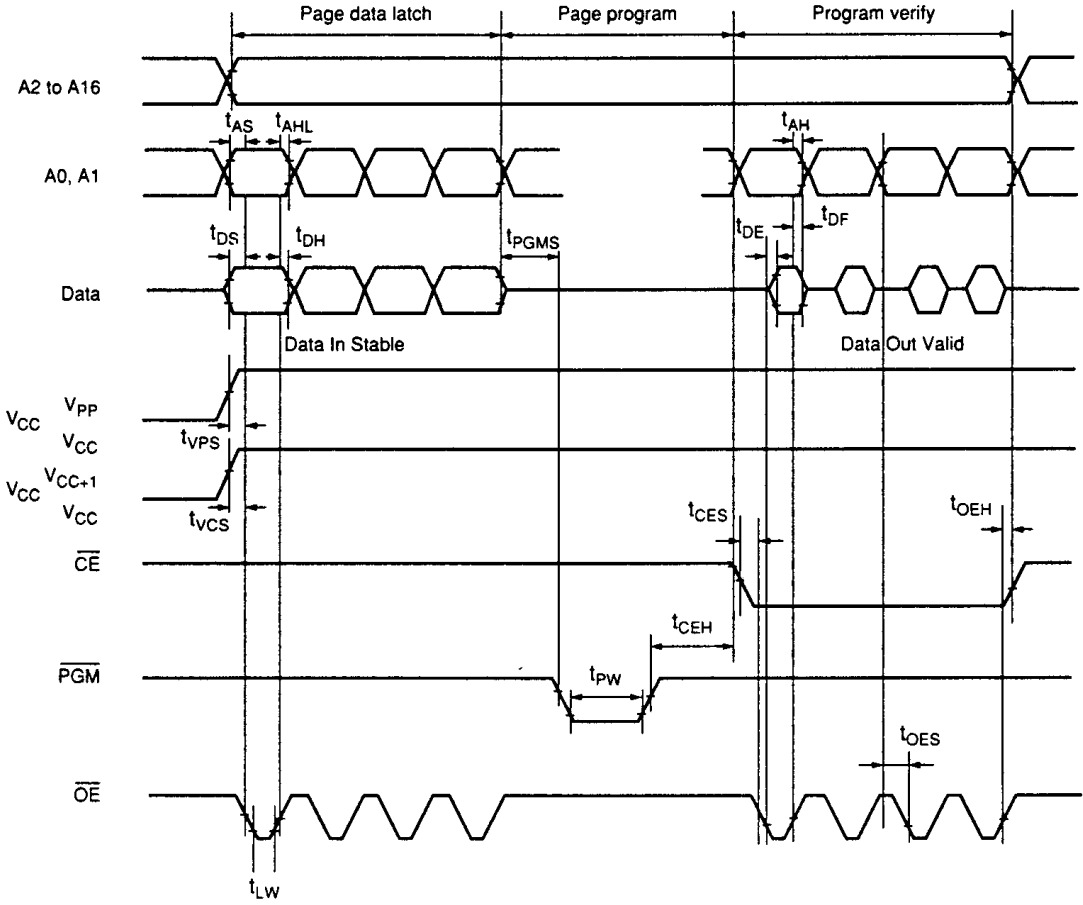

FIGURE 4. BYTE PROGRAMMING FLOWCHART

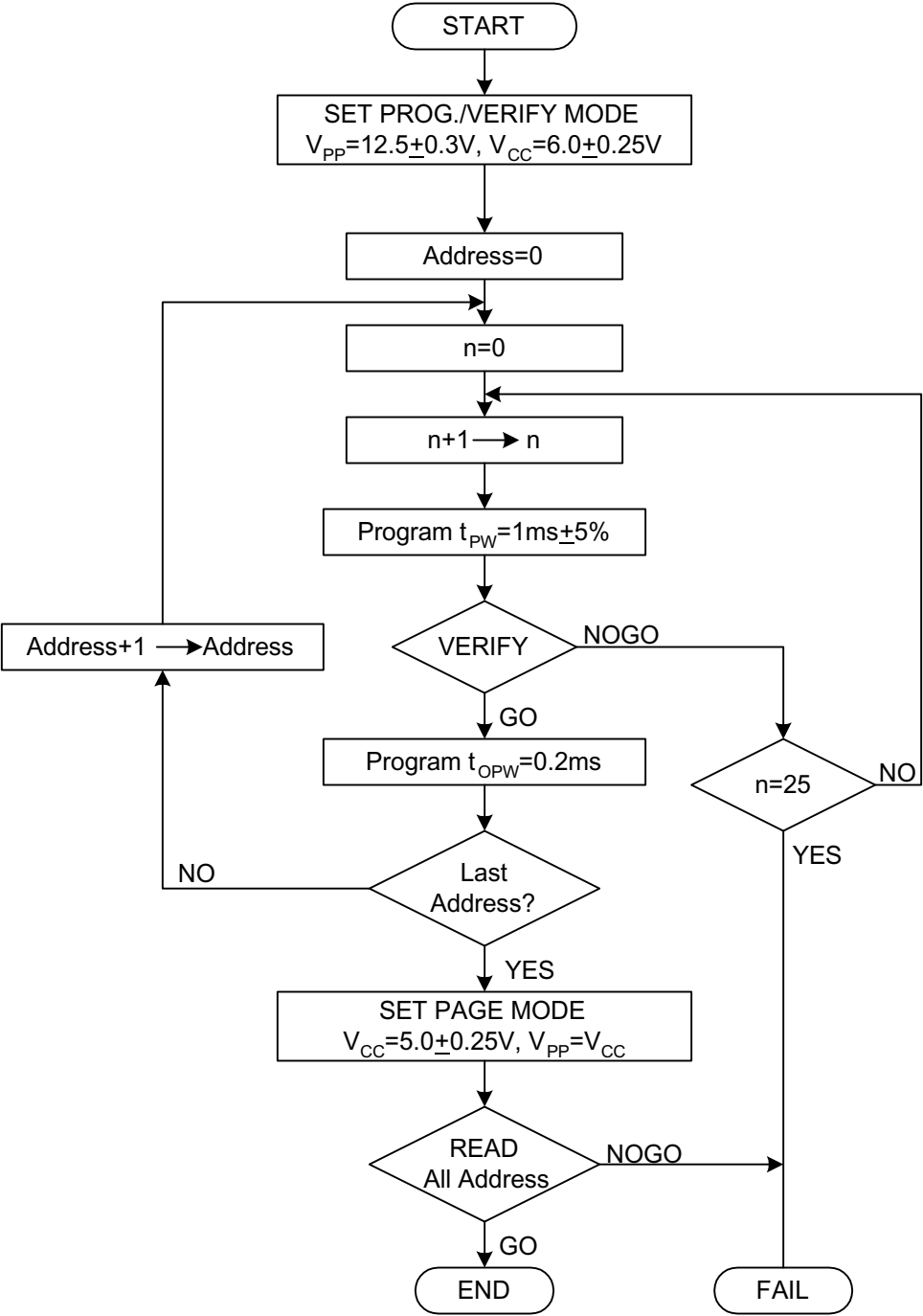
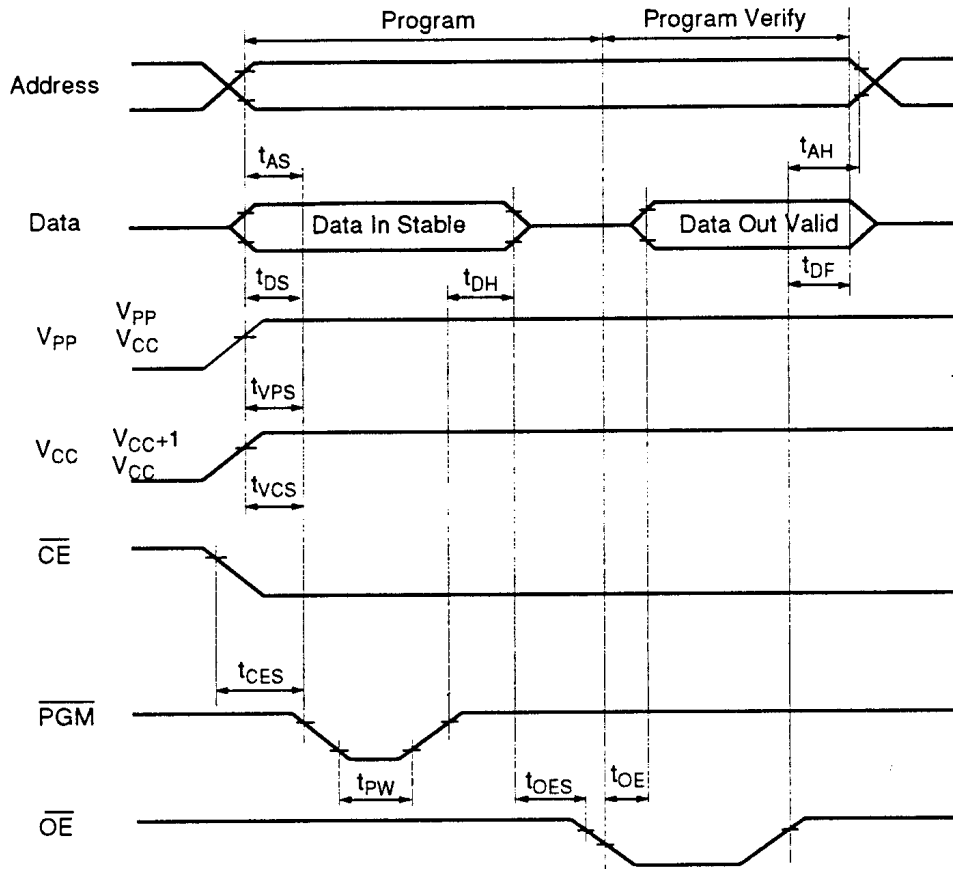

FIGURE 5. BYTE PROGRAMMING TIMING WAVEFORM



DEVICE IDENTIFIER MODE DESCRIPTION

The Device Identifier Mode allows binary codes to be read from the outputs that identify the manufacturer and the type of device. Using this mode with programming equipment, the device will automatically match its own erase and programming algorithm.

27C512T SERIES IDENTIFIER CODE

IDENTIFIER	A ₀	I/O ₇	I/O ₆	I/O ₅	I/O ₄	I/O ₃	I/O ₂	I/O ₁	I/O ₀	HEX DATA
MANUFACTURER CODE	V _{IL}	0	0	0	0	0	1	1	1	07
DEVICE CODE	V _{IH}	0	0	1	1	1	0	0	0	38

1. V_{CC} = 5.0V ± 10%.
2. A₀ = 12.0V ± 0.5V.
3. A₁-A₈, A₁₀-A₁₆, \overline{CE} , \overline{OE} = V_{IL}, \overline{PGM} = V_{IH}.
4. X = Don't care.

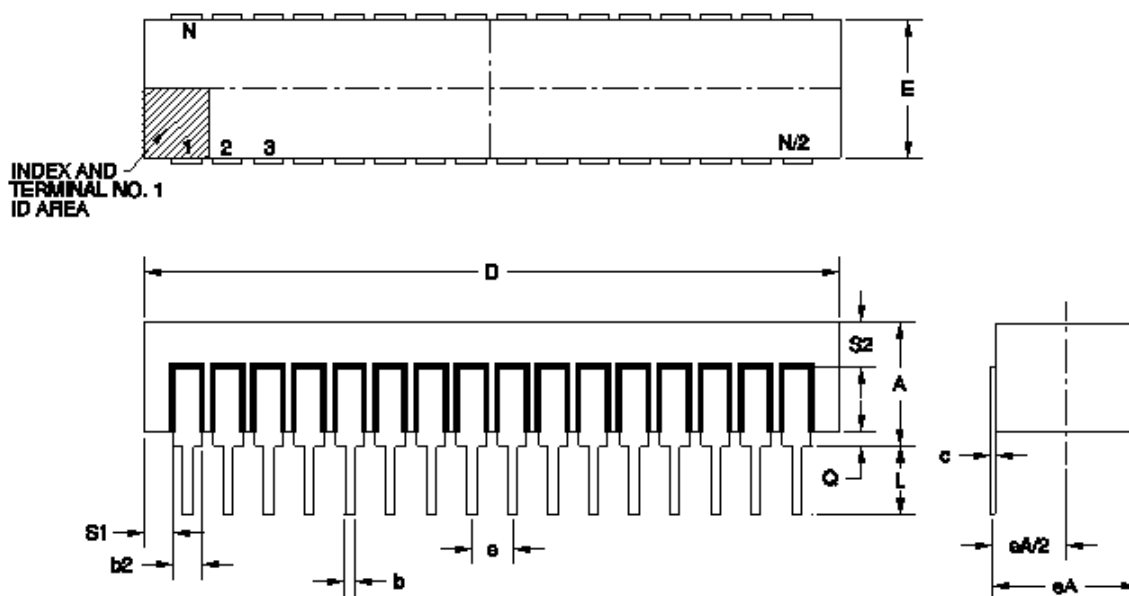

32 PIN RAD-PAK® DUAL IN LINE PACKAGE¹

SYMBOL	DIMENSION		
	MIN	NOM	MAX
A	--	0.215	0.240
b	0.014	0.018	0.026
b2	0.045	0.050	0.065
c	0.008	0.010	0.018
D	--	1.600	1.680
E	0.510	0.590	0.620
eA	0.600 BSC		
eA/2	0.300 BSC		
e	0.100 BSC		
L	0.125	0.145	0.155
Q	0.015	0.035	0.070
S1	0.005	0.025	--
S2	0.005	--	--
N	32		

1. Standard Product Screening Flow MIL-STD-883, Method 2001, Constant Acceleration: For this package type Constant Acceleration is 3000g's.

Note: All dimensions in inches

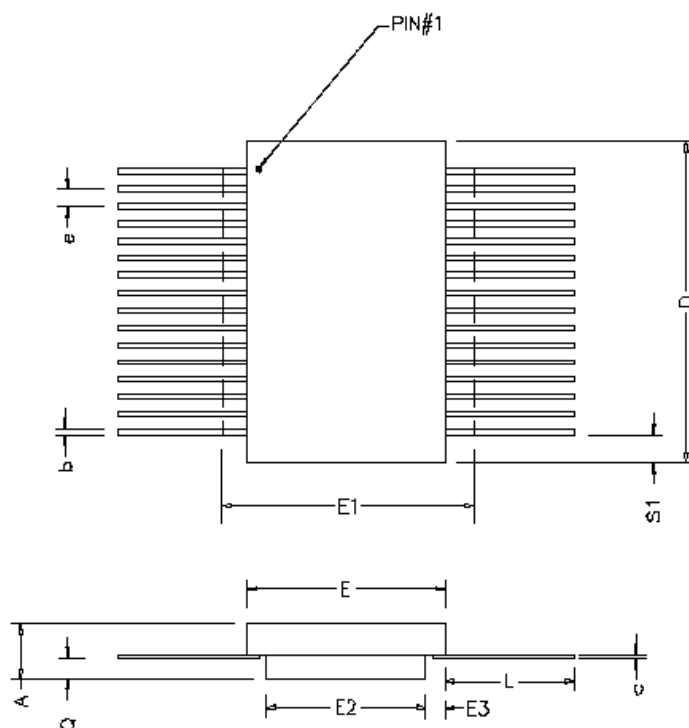

32 PIN RAD-PAK® FLAT PACKAGE

SYMBOL	DIMENSION		
	MIN	NOM	MAX
A	0.198	0.210	0.220
b	0.015	0.017	0.020
c	0.004	0.005	0.009
D	--	0.820	0.830
E	0.472	0.480	0.488
E1	--	--	0.498
E2	0.300	0.310	--
E3	0.030	0.085	--
e	0.050 BSC		
L	0.355	0.365	0.375
Q	0.055	0.065	0.075
S1	0.005	0.027	--
N	32		

Note: All dimensions in inches

Important Notice:

These data sheets are created using the chip manufacturers published specifications. Maxwell Technologies verifies functionality by testing key parameters either by 100% testing, sample testing or characterization.

The specifications presented within these data sheets represent the latest and most accurate information available to date. However, these specifications are subject to change without notice and Maxwell Technologies assumes no responsibility for the use of this information.

Maxwell Technologies' products are not authorized for use as critical components in life support devices or systems without express written approval from Maxwell Technologies.

Any claim against Maxwell Technologies must be made within 90 days from the date of shipment from Maxwell Technologies. Maxwell Technologies' liability shall be limited to replacement of defective parts.

Product Ordering Options

