

## Converter thyristor

### Type N1263xx43xxx to N1263xx52xxx

#### Absolute maximum ratings

	VOLTAGE RATINGS	MAXIMUM LIMITS	UNITS
$V_{DRM}$	Repetitive peak off-state voltage, (note 1).	4300-5200	V
$V_{DSM}$	Non-repetitive peak off-state voltage, (note 1).	4300-5200	V
$V_{RRM}$	Repetitive peak reverse voltage, (note 1).	4300-5200	V
$V_{RSM}$	Non-repetitive peak reverse voltage, (note 1).	4400-5300	V

	RATINGS	MAXIMUM LIMITS	UNITS
$I_{T(AV)}$	Mean on-state current, $T_{sink}=55^{\circ}C$ , (note 2).	2500	A
$I_{T(AV)}$	Mean on-state current. $T_{sink}=85^{\circ}C$ , (note 5).	1750	A
$I_{T(AV)}$	Mean on-state current. $T_{sink}=85^{\circ}C$ , (note 3).	1080	A
$I_{T(RMS)}$	Nominal RMS on-state current, $25^{\circ}C$ , (note 2).	4880	A
$I_{T(d.c.)}$	D.C. on-state current, $25^{\circ}C$ , (note 7).	4350	A
$I_{TSM}$	Peak non-repetitive surge $t_p=10ms$ , $V_{RM}=0.6V_{RRM}$ , (note 4).	$37.8 \times 10^3$	A
$I_{TSM2}$	Peak non-repetitive surge $t_p=10ms$ , $V_{RM} \leq 10V$ , (note 4).	$42.0 \times 10^3$	A
$I^2t$	$I^2t$ capacity for fusing $t_p=10ms$ , $V_{RM}=0.6V_{RRM}$ , (note 4).	$7.1 \times 10^6$	$A^2s$
$I^2t$	$I^2t$ capacity for fusing $t_p=10ms$ , $V_{RM} \leq 10V$ , (note 4).	$8.8 \times 10^6$	$A^2s$
$I^2t$	$I^2t$ capacity for fusing $t_p=3ms$ , $V_{RM} \leq 0.6V_{RRM}$ , (note 4).	$5.1 \times 10^6$	$A^2s$
$di/dt$	Critical rate of rise of on-state current (continuous), (note 6).	150	$A/\mu s$
	Critical rate of rise of on-state current (intermittent), (note 6).	300	$A/\mu s$
$I_{FGM}$	Peak forward gate current.	10	A
$V_{RGM}$	Peak reverse gate voltage.	5	V
$P_{G(AV)}$	Mean forward gate power.	5	W
$P_{GM}$	Peak forward gate power.	30	W
$V_{GD}$	Non-trigger gate voltage, (Note 5).	0.25	V
$T_{HS}$	Operating temperature range.	-40 to +125	$^{\circ}C$
$T_{stg}$	Storage temperature range.	-40 to +150	$^{\circ}C$

#### Notes:-

- 1) De-rating factor of 0.13% per K is applicable for  $T_j$  below  $25^{\circ}C$ .
- 2) Doubleside cooled, single phase; 50Hz,  $180^{\circ}$  half-sinewave.
- 3) Singleside cooled, single phase; 50Hz,  $180^{\circ}$  half-sinewave.
- 4) Half-sinewave,  $125^{\circ}C$   $T_j$  initial.
- 5) Rated  $V_{DRM}$ .
- 6)  $V_D=67\%V_{DRM}$ ,  $I_T=5000A$ ,  $I_{FG}=2A$ ,  $t_r=500ns$ .
- 7) Doubleside cooled.

**Characteristics**

	CHARACTERISTICS	MIN	TYP	MAX	TEST CONDITIONS	UNITS
$V_{TM}$	Maximum peak on-state voltage.	-	-	2.00	$I_T=4000A$ .	V
$V_0$	Threshold voltage.	-	-	1		V
$R_T$	Slope resistance.	-	-	0.25		m $\Omega$
dv/dt	Critical rate of rise of off-state voltage.	200	1000	2000	$V_D=80\% V_{DRM}$ .	V/ $\mu$ s
$I_{DRM}$	Peak off-state current.	-	-	300	Rated $V_{DRM}$ note 2.	mA
$I_{RRM}$	Peak reverse current.	-	-	300	Rated $V_{RRM}$ note 2.	mA
$V_{GT}$	Gate trigger voltage	-	-	3.0	$T_J=25^\circ C$ .	V
$I_{GT}$	Gate trigger current	-	-	300	$T_J=25^\circ C$ . $V_D=10V$ , $I_A=3A$	mA
$I_H$	Holding current	-	-	1000	$T_J=25^\circ C$ .	mA
$R_\theta$	Thermal resistance junction to sink.	-	-	11	Double side cooled.	K/KW
		-	-	22	Single side cooled.	K/KW
F	Mounting force.	63	-	77		kN
$W_t$	Weight.	-	1.23	-		kg

## Notes:-

- 1) Unless otherwise indicated  $T_J=125^\circ C$ .
- 2) Leakage current limit, this will be increased in the future to 600mA

**Notes on Ratings and Characteristics**

**1 Voltage Grade Table**

Voltage Grade 'H'	$V_{DSM}$ $V_{DRM}$ $V_{RRM}$ V	$V_{RSM}$ V	$V_D$ $V_R$ $V_{DC}$
44	4400	4500	2420
46	4600	4700	2530
48	4800	4900	2640
50	5000	5100	2750
52	5200	5300	2860

**2 Extension of Voltage Grades**

This report is applicable to other and higher voltage grades when supply has been agreed by Sales/Production.

**3 De-rating Factor**

A blocking voltage de-rating factor of 0.13% per °C is applicable to this device for  $T_J$  below 25 °C.

**4 Repetitive dv/dt**

Higher dv/dt selections are available up to 2000V/μs on request.

**5 Computer modelling parameters**

5.1 Device dissipation calculations

$$I_{AV} = \frac{-V_o + \sqrt{V_o^2 + 4 \cdot ff^2 \cdot r_s \cdot W_{AV}}}{2 \cdot ff^2 \cdot r_s}$$

Where  $V_o = 1.00$  V,  $r_s = 0.250$ mΩ

$$W_{AV} = \frac{\Delta T}{R_{th}} \quad \Delta T = T_{jMax} - T_{Hs}$$

$R_{th}$  = Supplementary thermal impedance, see table below.

$ff$  = Form factor, see table below.

Supplementary Thermal Impedance (at 50Hz operating frequency)				
Conduction Angle	6 phase (60°)	3 phase (120°)	Half wave (180°)	d.c.
Square wave Double Side Cooled	0.0118	0.0115	0.0112	0.0110
Square wave Single Side Cooled	0.0236	0.0230	0.0224	0.0220
Sine wave Double Side Cooled	0.0116	0.0112	0.0101	
Sine wave Single Side Cooled	0.0232	0.0224	0.0202	

Form Factors				
Conduction Angle	60°	120°	180°	d.c.
Square wave	2.45	1.73	1.41	1
Sine wave	2.78	1.88	1.57	

### 5.2 Calculating $V_T$ using ABCD coefficients

The on-state characteristic  $I_T$  vs  $V_T$ , on Fig. 9, is represented in two ways; (i) the well established  $V_0$  and  $r_S$  tangent and (ii) a set of constants A, B, C, D, forming the coefficients of the representative equation for  $V_T$  in terms of  $I_T$  given below:

$$V_T = A + B \cdot \ln(I_T) + C \cdot I_T + D \cdot \sqrt{I_T}$$

The constants, derived by curve fitting software, are given in this report for both hot and cold characteristics where possible. The resulting values for  $V_T$  agree with the true device characteristic over a current range, which is limited to that plotted.

125°C Coefficients		25°C Coefficients	
A	$1.00 \times 10^{00}$	A	$9.82 \times 10^{-01}$
B	$-1.41 \times 10^{-13}$	B	$3.72 \times 10^{-03}$
C	$2.60 \times 10^{-04}$	C	$2.61 \times 10^{-04}$
D	$1.57 \times 10^{-14}$	D	$-2.93 \times 10^{-04}$

### 5.3 D.C. Thermal impedance calculation

$$r_t = \sum_{p=1}^{p=n} r_p \left( 1 - e^{-\frac{t}{\tau_p}} \right)$$

Where  $p = 1$  to  $n$ ,  $n$  is the number of terms in the series.

$t$  = Duration of heating pulse in seconds.

$r_t$  = Thermal resistance at time  $t$ .

$r_p$  = Amplitude of  $p_{th}$  term.

$\tau_p$  = Time Constant of  $r_{th}$  term.

D.C. Double Side Cooled				
Term	1	2	3	4
$r_p$	$5.214 \times 10^{-03}$	$1.901 \times 10^{-03}$	$2.560 \times 10^{-03}$	$8.720 \times 10^{-04}$
$\tau_p$	$9.882 \times 10^{-01}$	$3.481 \times 10^{-01}$	$1.147 \times 10^{-01}$	$8.180 \times 10^{-03}$

D.C. Single Side Cooled					
Term	1	2	3	4	5
$r_p$	N/A	N/A	N/A	N/A	N/A
$\tau_p$	N/A	N/A	N/A	N/A	N/A

Curves

Figure 1, Maximum on-state characteristic

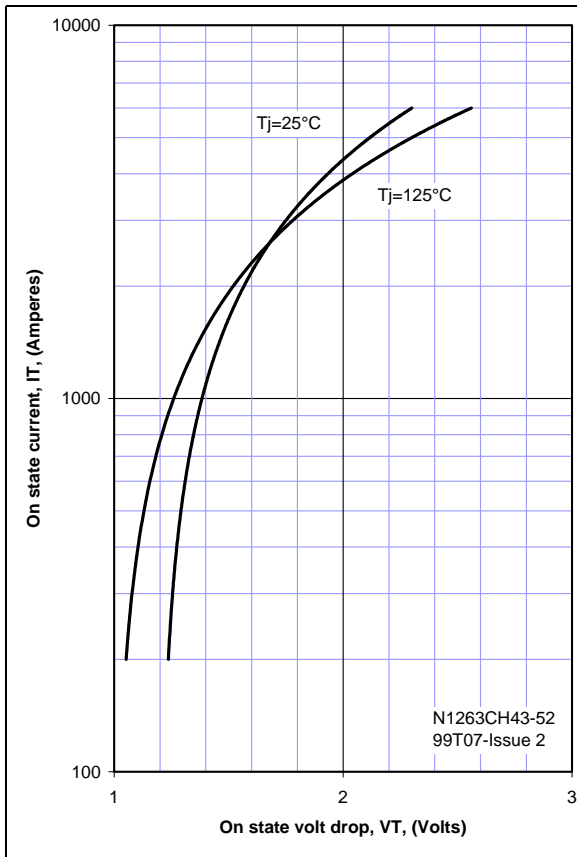

Figure 2, Transient thermal impedance

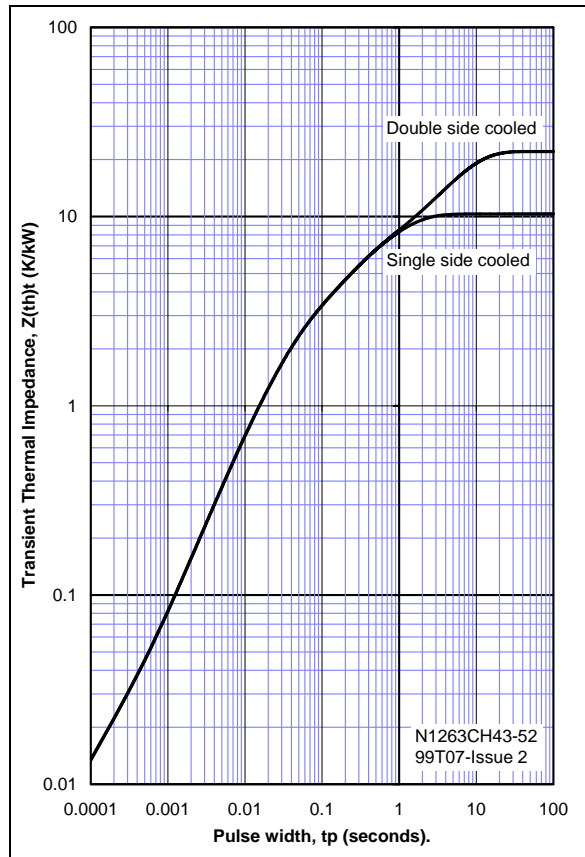

Figure 3, Maximum non repetitive surge

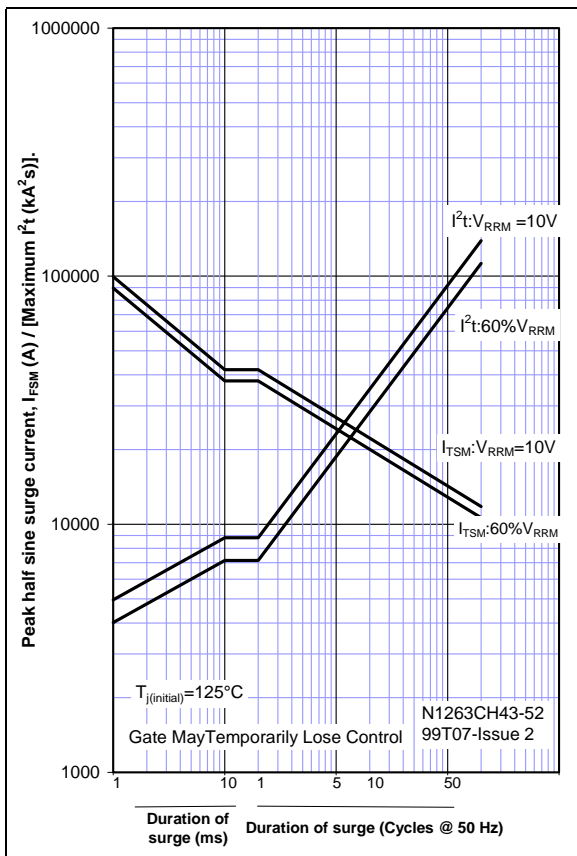
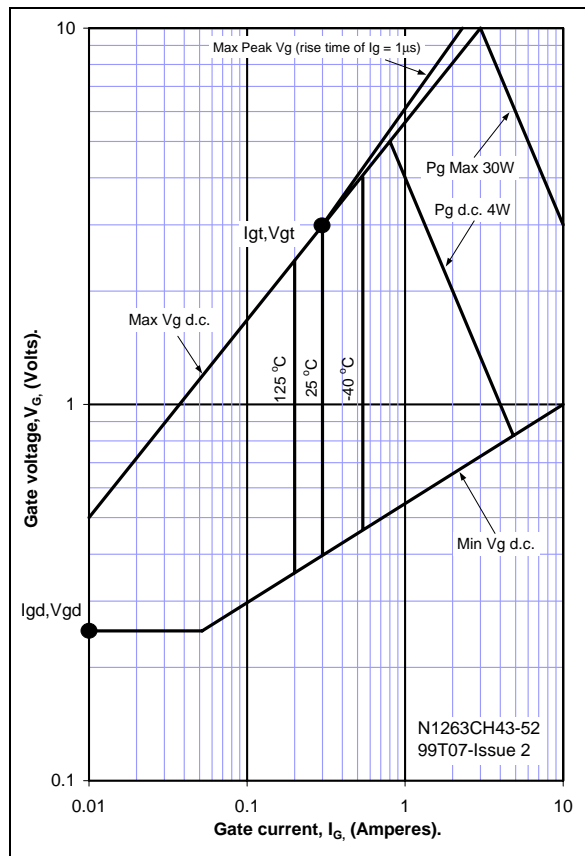
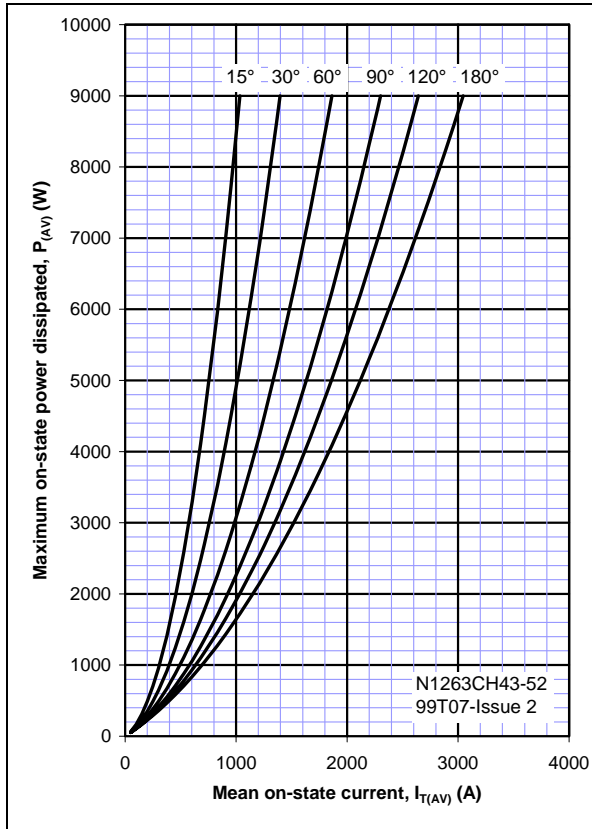

Figure 4, Gate characteristics, 25°C



**Figure 5, Power dissipation vs. mean current, sinewave, double side cooled**



**Figure 6, Power dissipation vs. mean current, sinewave, single side cooled**

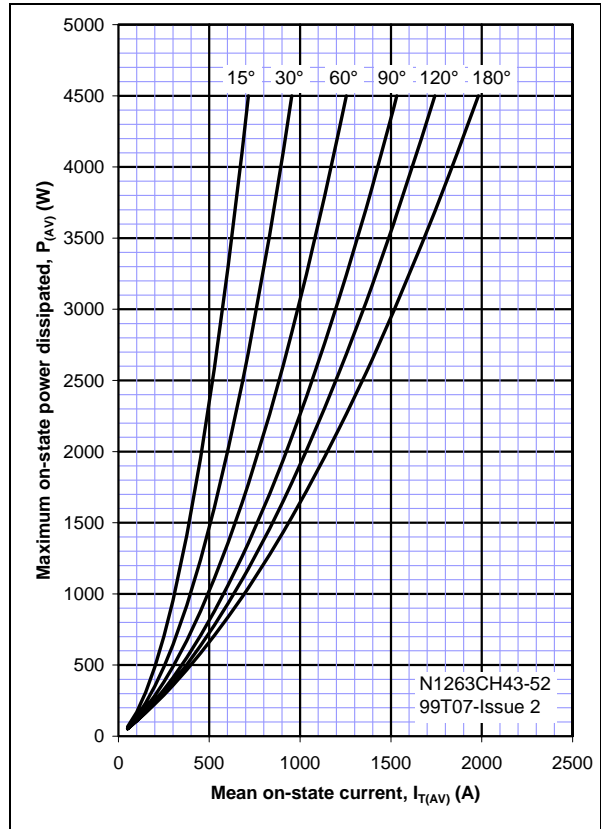

**Figure 7, Heatsink temperature vs. mean current, sinewave, double side cooled**

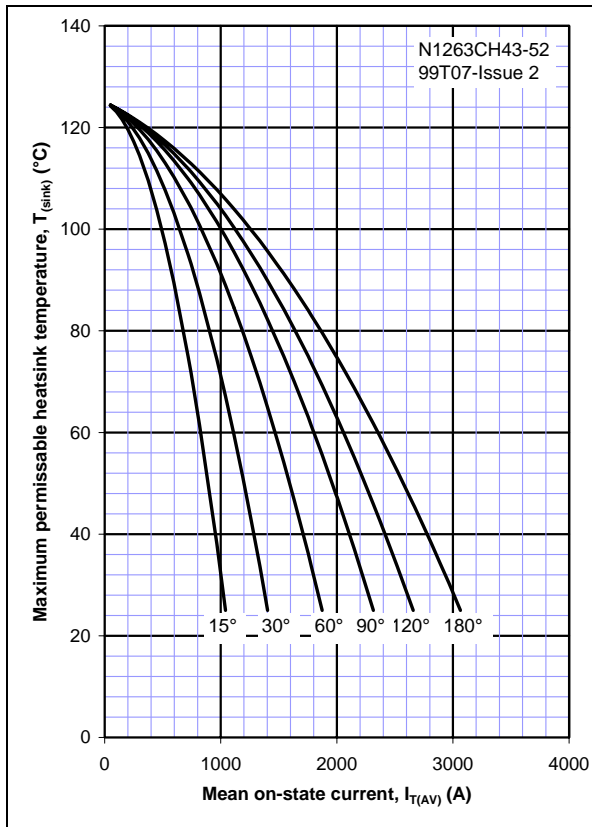

**Figure 8, Heatsink temperature vs. mean current, sinewave, single side cooled**

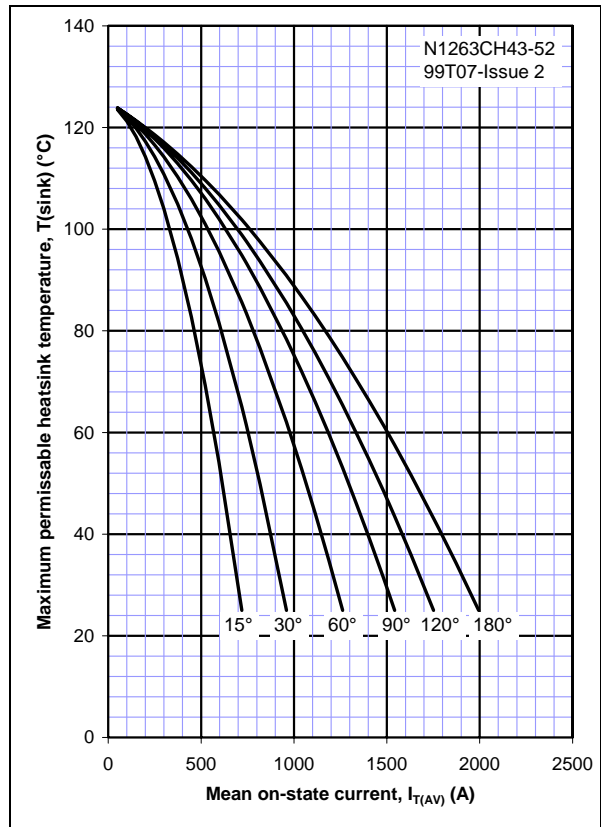

**Figure 9, Power dissipation vs. mean current, squarewave, double side cooled**

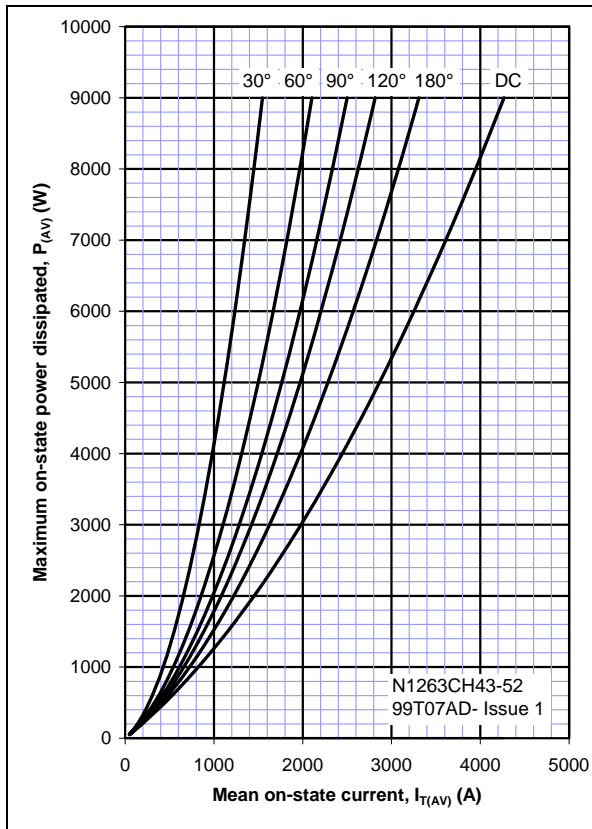

**Figure 10, Power dissipation vs. mean current, squarewave, single side cooled**

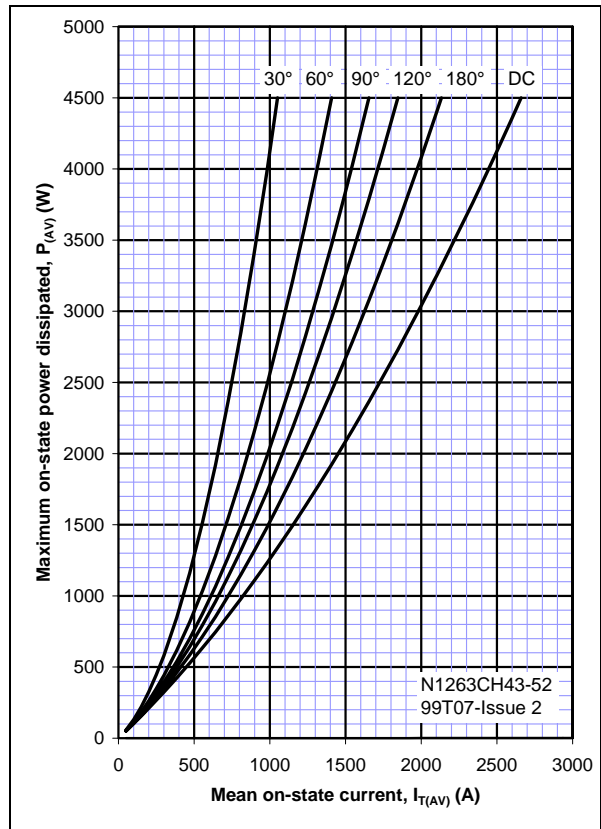

**Figure 11, Heatsink temperature vs. mean current, squarewave, double side cooled**

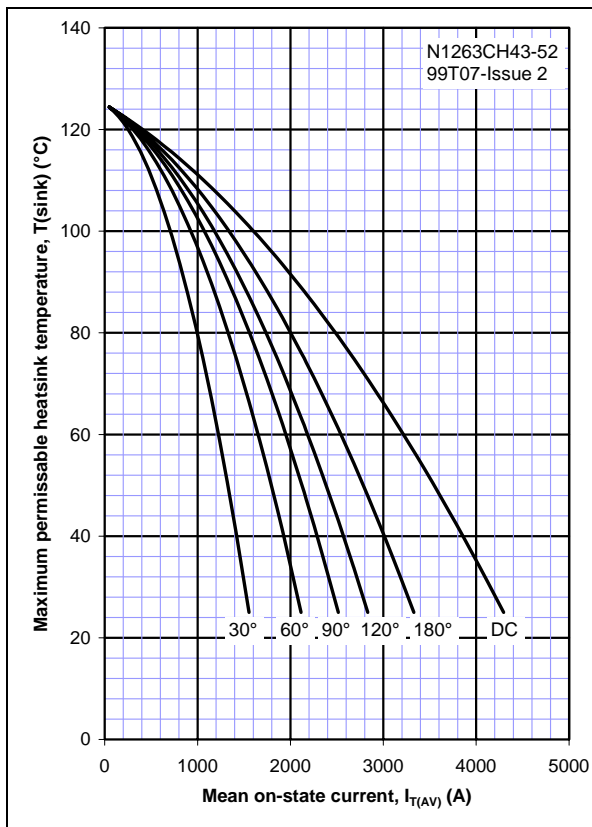

**Figure 12, Heatsink temperature vs. mean current, squarewave, single side cooled**

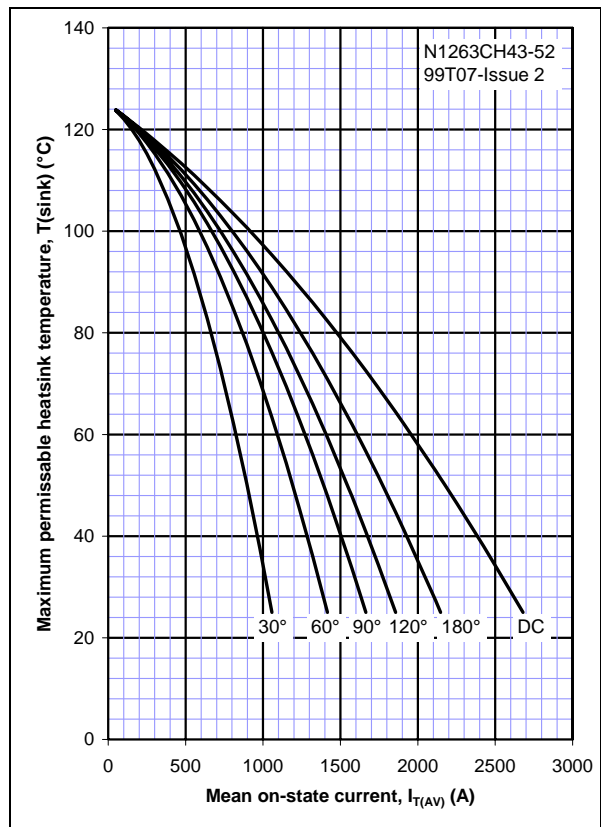

Outline drawing & ordering information

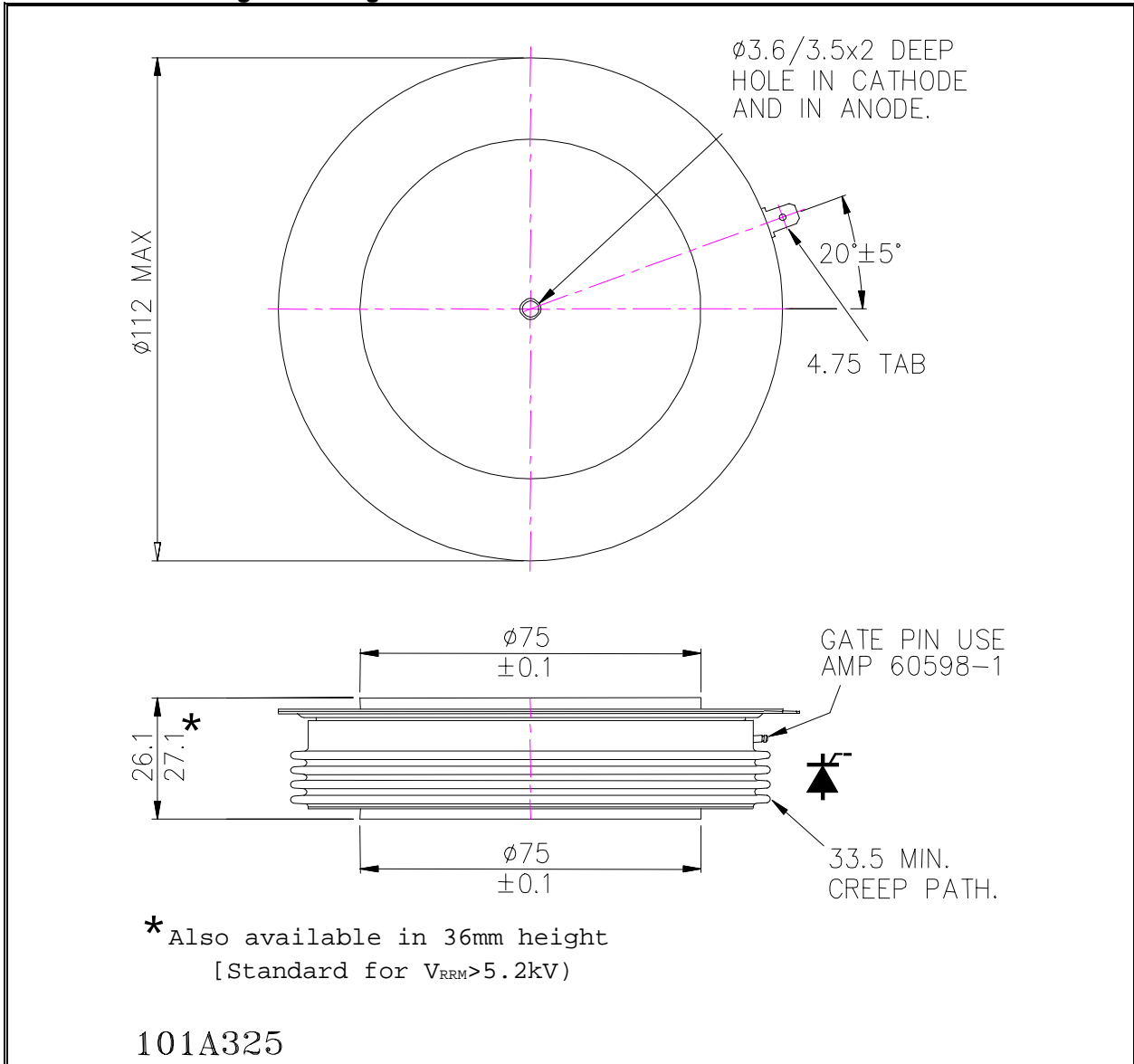

ORDERING INFORMATION		(Please quote 12 digit code as below)			
<b>N1063</b>	◆	◆	◆◆	◆◆◆	
Fixed Type Code	Outline Code		Voltage Code $V_{DRM} / 100$	dv/dt Code	
	C – 26mm Height	H – standard explosion		Blank = 200V/ $\mu$ s	GOO = 300V/ $\mu$ s
	D – 36mm Height	Z – enhanced explosion	JOO = 500V/ $\mu$ s	KOO = 750V/ $\mu$ s	LOO = 1000V/ $\mu$ s
Typical order code : N1263CZ52 – 5.2kV $V_{DRM}$ , 26mm high, enhanced explosion rating capsule thyristor					

<h1 style="color: red;">WESTCODE</h1> <p><a href="http://www.westcode.com">http://www.westcode.com</a></p>	<p><b>U.K: Westcode Semiconductors Ltd</b>                  P.O. Box 57, Chippenham, England SN15 1JL                  Tel: +44 (0)1249444524 Fax: +44 (0)1249 659448                  E-mail: WSL.sales@westcode.com</p> <p><b>USA: Westcode Semiconductors Inc</b>                  3270 Cherry Avenue, Long beach, California 90807                  Tel: 562 595 6971 Fax: 562 595 8182</p>
--	---

In the interest of product improvement, Westcode Semiconductors reserves the right to change specifications at any time without notice ©Westcode Semiconductors Ltd