

# コモンモードチョークコイル (DC、信号ライン用) SMDタイプ

## COMMON MODE CHOKE COILS (FOR DC AND SIGNAL LINES) SMD TYPE



リフロー／REFLOW

OPERATING TEMP.	-25~+105°C (製品自己発熱を含む) (Including self-generated heat)
-----------------	---

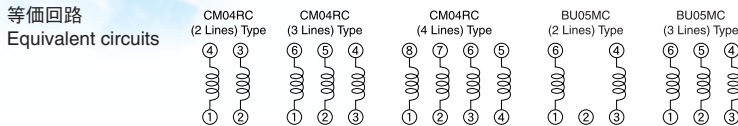

### 特長 FEATURES

#### CM04RC・BU05MC

- ・SMT対応
- ・高結合なコイル構造によりコモンモードノイズの除去に最適

#### CM04CR / BU05MC

- ・ Available in embossed tape and reel.
- ・ Highly coupled coil construction ideal for common mode noise attenuation

### 用途 APPLICATIONS

- ・多機能電話機、PBX、FAXなど外線の不要輻射電界および放送波に対するイミュニティ対策
- ・各種電子機器のDCラインのノイズ対策
- ・ACアダプタ、バッテリーチャージャー及び各種デジタル機器の電源2次側ライン、信号ラインの不要輻射対策
- ・DVC、DSC等の電源、2次側DCラインの不要輻射対策。
- ・パーソナルコンピューター、プリンター、スキャナー等のUSB(D+,D-)及びIEEE1394の高速差動伝送のノイズ除去。

- ・ Immunity against undesirable external line radiation fields and broadcast waves generated by multifunction telephone sets, PBXs, and facsimile machines.
- ・ Preventive measure against DC line noise in electronic equipment.
- ・ Suppresses radiated emissions from secondary power supplies and signal lines on AC adapters, battery chargers, and digital equipment.
- ・ Excellent for reducing radiated noise in DVC (digital video cameras) and DSC (digital still cameras)
- ・ Offers high speed differential mode noise attenuation in USB and IEEE1394 connectors in personal computers, printers, scanners and other computer peripherals

### 形名表記法 ORDERING CODE

<b>1</b> 形式 CM BU	コモンモードチョークコイル	<b>3</b> 形状 RC MC	実装タイプ	<b>4</b> 試作番号 01~13	<b>5</b> 包装記号 T	テーピング品
<b>2</b> コアの長辺寸法 (mm) 04 05	3.5 5.0				<b>6</b> 当社管理番号 △	標準品 △=スペース



<b>1</b> Type CM BU	Common mode choke coils	<b>3</b> Shape RC MC	Surface mount type	<b>4</b> Product classification code 01 to 13	<b>5</b> Packaging T	Taped products
<b>2</b> Dimensions of Core(dia.)(mm) 04 05	3.5 5.0				<b>6</b> Internal code △	Standard Products △=Blank space

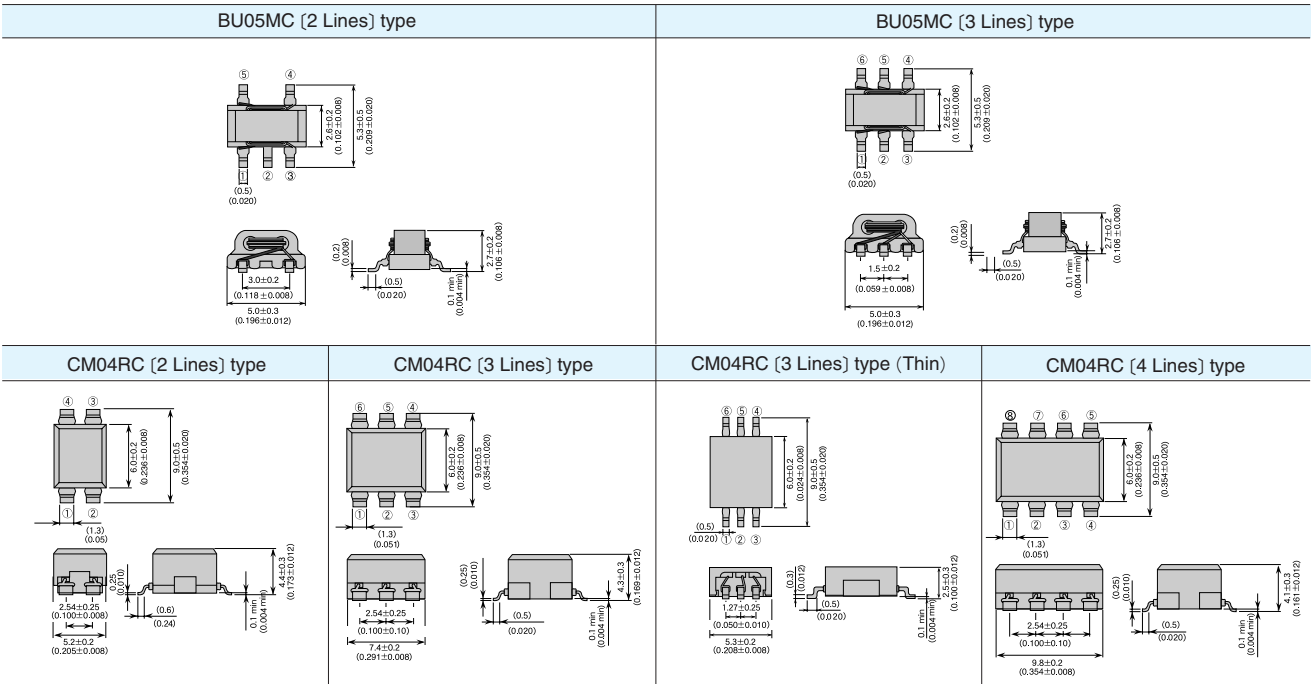

公差のない数値は参考値です。The values without tolerance are for reference only.

アイテム一覧 PART NUMBERS

CM04RCタイプ

形名 Ordering code	ライン数 No. of Lines	インピーダンス Impedance [Ω] (typical)	直流抵抗 DC resistance [Ω] (max.)	定格電流 Rated current [A] (max.)	定格電圧 Rated voltage [V] (D.C.)	絶縁抵抗 Insulation resistance [MΩ] (min.)
CM04RC01T	2	800 (at 100MHz)	0.06	1.5	50	100
CM04RC03T		500 (at 480MHz)	0.06	2.0		
CM04RC04T		900 (at 15MHz)	0.1	1.0		
CM04RC07T		500 (at 160MHz)	0.06	2.5		
CM04RC09T		270 (at 200MHz)	0.03	3.0		
CM04RC10T		100 (at 200MHz)	0.02	4.0		
CM04RC02T	3	1000 (at 100MHz)	0.18	0.5		
CM04RC08T (THIN)		1000 (at 200MHz)	0.2	0.5		
CM04RC05T	4	800 (at 100MHz)	0.2	0.5		

BU05MCタイプ

形名 Ordering code	ライン数 No. of Lines	インピーダンス Impedance [Ω] (typical)	直流抵抗 DC resistance [Ω] (max.)	定格電流 Rated current [A] (max.)	定格電圧 Rated voltage [V] (D.C.)	絶縁抵抗 Insulation resistance [MΩ] (min.)
BU05MC01T	2	1000 (at 60MHz)	0.12	1	50	100
BU05MC03T		600 (at 100MHz)	0.10	1.5		
BU05MC05T		1700 (at 130MHz)	0.12	1		
BU05MC07T		1200 (at 250MHz)	0.11	1		
BU05MC13T		1000 (at 200MHz)	0.06	1		
BU05MC02T	3	1000 (at 150MHz)	0.15	0.5		
BU05MC08T		700 (at 60MHz)	0.11	0.5		
BU05MC11T		800 (at 350MHz)	0.09	0.5		

セクションガイド  
Selection Guide

アイテム一覧  
Part Numbers

特性図  
Electrical Characteristics

梱包  
Packaging

信頼性  
Reliability Data

使用上の注意  
Precautions



etc

インピーダンス周波数特性例 Impedance -vs- Frequency characteristics(Measured by HP4291A)

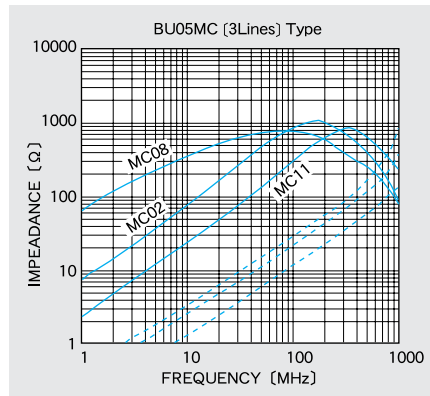
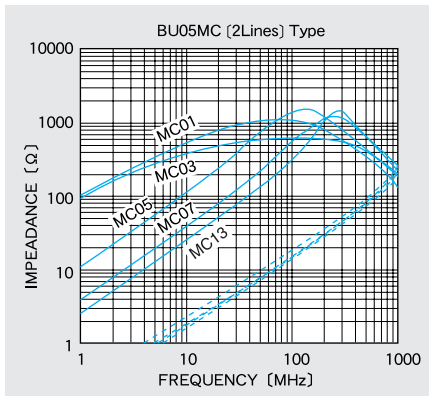
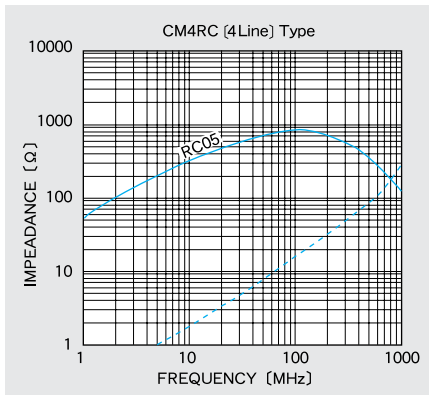
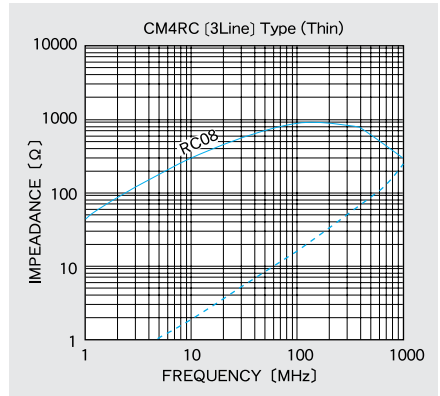
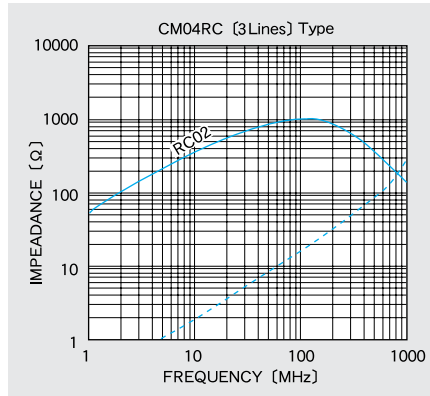
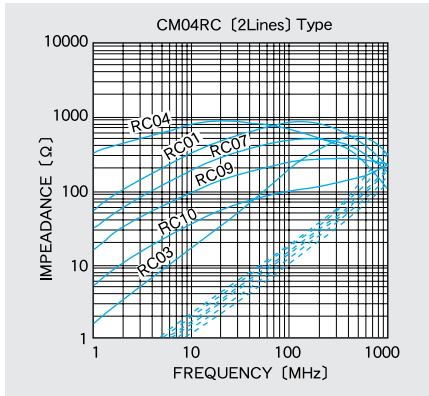

— コモンモード  
 - - - ノーマルモード

①標準数量 Standard quantity

Type	標準数量 (pcs.) Standard quantity
	テーピング Taping
CM04RC [2 Lines] type	1500
CM04RC [3 Lines] type	1000
CM04RC [3 Lines] type (Thin)	2500
CM04RC [4 Lines] type	1000
BU05MC [2 Lines] type	2500
BU05MC [3 Lines] type	2500

④リール寸法 Reel size

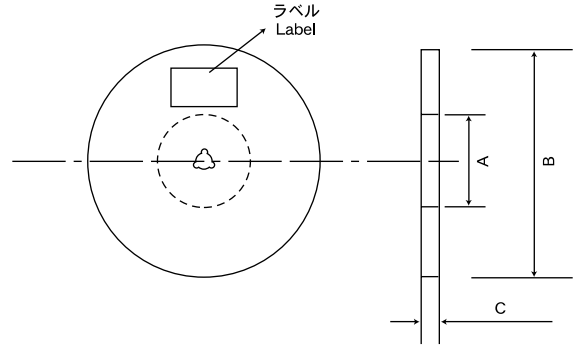

Type	A	B	C
CM04RC	$\phi 100 \pm 1$ ( $\phi 3.94 \pm 0.039$ )	$\phi 330 \pm 2$ ( $\phi 12.99 \pm 0.079$ )	$18 \pm 1.5$ ( $0.709 \pm 0.059$ )
BU05MC	$\phi 80 \pm 1$ ( $\phi 3.15 \pm 0.039$ )	$\phi 330 \pm 2$ ( $\phi 12.99 \pm 0.079$ )	$13.5 \pm 1$ ( $0.53 \pm 0.039$ )

Unit : mm(inch)

②テーピング材質 Tape Material

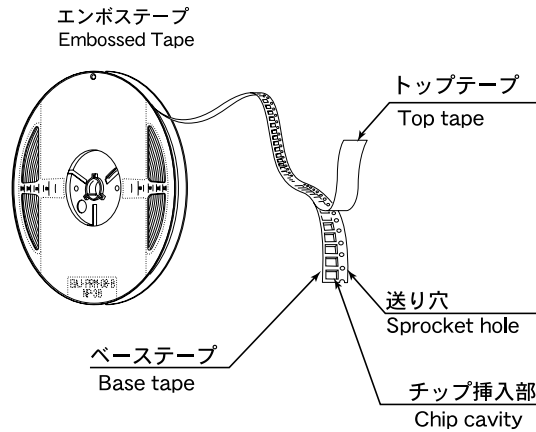

③リーダー部・空部 Leader and Blank Portion

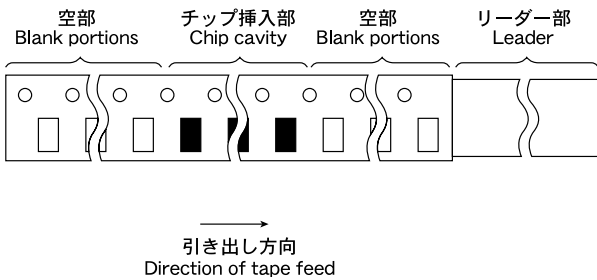

Type	リーダー部 Leader	空部 (リーダー部側) Blank portions (Leader side)	空部 (チップ挿入部側) Blank portions (Chip cavity side)
CM04RC	150(5.89)	80(3.14)	80(3.14)
BU05MC	150(5.89)	80(3.14)	80(3.14)

Unit : mm(inch)

エンボステープ (CM04RCタイプ) Embossed tape (CM04RC type)  
 (1) 8mm pitch (0.31 inches pitch)

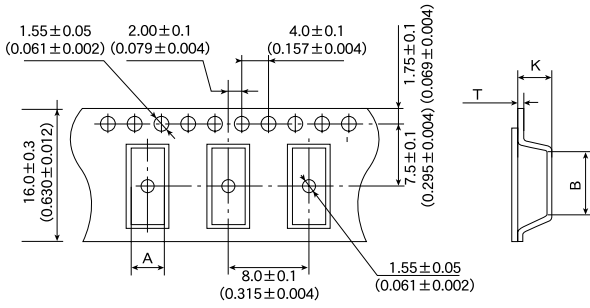

(2) 12mm pitch (0.472 inches pitch)

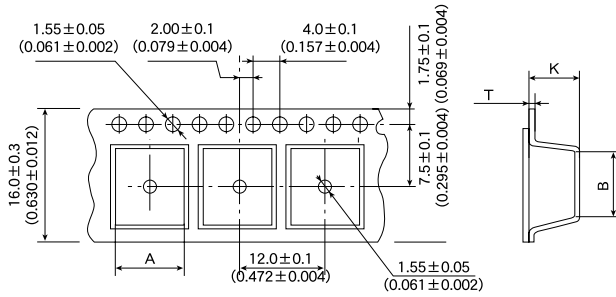

エンボステープ (BU05MCタイプ) Embossed tape (BU05MC type)

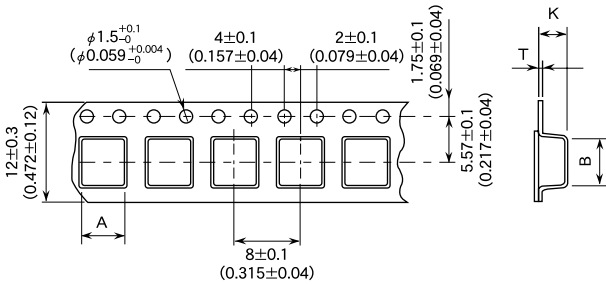

Type	ライン数 Lines	挿入ピッチ Insertion pitch	チップ挿入部 Chip cavity		テープ厚み Tape thickness	
			A	B	K	T
CM04RC	2	8.0±0.1	5.7±0.1	9.65±0.1	5.2max	0.4±0.05
	3	12.0±0.1	9.8±0.1	7.7±0.1	5.0max	0.38±0.05
	3 (THIN)	8.0±0.1	5.7±0.1	9.8±0.1	3.1max	0.4±0.05
BU05MC	2	8.0±0.1	5.35±1.5	5.7±0.2	3.2±0.1	0.4±0.05
BU05MC	3	8.0±0.1	5.35±1.5	5.7±0.2	3.2±0.1	0.4±0.05

⑥ トップテープ強度 Top Tape Strength

トップテープのはがし力は、下図矢印方向にて0.1~0.7Nとなります。  
 The top tape requires a peel-off force of 0.1 to 0.7N in the direction of the arrow as illustrated below.

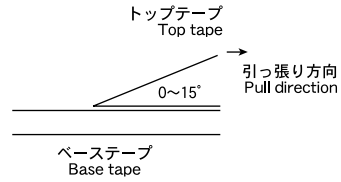

Item	Specified Value					Test Method and Remarks										
	Surface Mount High current inductors 08 Type	Surface Mount High current inductors 04/05/06 Type	CommonMode Choke Coils CM04RC	CommonMode Choke Coils BU05MC	Balun Transformers BU05MC											
1. Operating Temperature Range	-25°C~+85°C	-25~+105°C				Including self-generated heat										
2. Storage Temperature Range	-40°C~+85°C					Common mode choke coil Balun transformers : -5 to +40°C in taped packaging										
3. Rated current	Within the specification		Within the specified tolerance			MSD inductor : The maximum DC value having inductance decrease within specified value and temperature increase within 40°C by the application of DC bias.  Inductance decrease <table border="1"> <tr> <td>04</td> <td>05</td> <td>06</td> </tr> <tr> <td>30%</td> <td>20%</td> <td>10%</td> </tr> </table> Common mode choke coil : The maximum DC value having temperature increase within specified temperature, as detailed in individual specification.	04	05	06	30%	20%	10%				
04	05	06														
30%	20%	10%														
4. Impedance			Within the specified tolerance			Common mode choke coil : Measuring equipment : HP 4291A or its equivalent Measuring frequency : Specified frequency										
5. Inductance	Within the specified tolerance				Refer to individual specification	SMD inductor : Measuring equipment : HP 4284A or its equivalent Measuring frequency : 1kHz Measuring voltage : 1V osc. Measurement in series connection										
6. DC Resitance	Within the specified tolerance					SMD transformer · SMD inductor · Common mode choke coil : Measuring equipment : DC ohmmeter										
7. Self resonance frequency	Within the specification					SMD inductor : Measuring equipment : Impedance analyzer (HP 4191A, 4192A) or its equivalent										
8. Temperature characteristic	04, 05, 06 Type : Within ±10% 08 Type : Within ±5%					SMD inductor : Change of maximum inductance deviation in step 1 to 5 <table border="1"> <tr> <td>Temperature at step 1</td> <td>20°C</td> </tr> <tr> <td>Temperature at step 2</td> <td>Minimum operating temperature</td> </tr> <tr> <td>Temperature at step 3</td> <td>20°C (Standard temperature)</td> </tr> <tr> <td>Temperature at step 4</td> <td>Maximum operating temperature</td> </tr> <tr> <td>Temperature at step 5</td> <td>20°C</td> </tr> </table>	Temperature at step 1	20°C	Temperature at step 2	Minimum operating temperature	Temperature at step 3	20°C (Standard temperature)	Temperature at step 4	Maximum operating temperature	Temperature at step 5	20°C
Temperature at step 1	20°C															
Temperature at step 2	Minimum operating temperature															
Temperature at step 3	20°C (Standard temperature)															
Temperature at step 4	Maximum operating temperature															
Temperature at step 5	20°C															
9. Resitance to flexure of substrate			Can satisfy the conditions of the chart at right.			Common mode choke coil : According to JIS C0051 <table border="1"> <tr> <td></td> <td>CM04RC · BU05MC</td> </tr> <tr> <td>Warp</td> <td>3mm</td> </tr> <tr> <td>Pressing speed</td> <td>0.5mm/sec.</td> </tr> <tr> <td>Duration</td> <td>5±1sec.</td> </tr> </table> 		CM04RC · BU05MC	Warp	3mm	Pressing speed	0.5mm/sec.	Duration	5±1sec.		
	CM04RC · BU05MC															
Warp	3mm															
Pressing speed	0.5mm/sec.															
Duration	5±1sec.															

Item	Specified Value					Test Method and Remarks									
	Surface Mount High current inductors 08 Type	Surface Mount High current inductors 04/05/06 Type	CommonMode Choke Coils CM04RC	CommonMode Choke Coils BU05MC	Balun Transformers BU05MC										
10.Standard donndityonn	Note on standard condition: "standard condition" referred to herein is defined as follows: 5 to 35°C of temperature, 45 to 85% relative humidity and 86 to 106kPa of air pressure. When there are questions concerning measurement results: In order to provide correlation data, the test shall be conducted under condition of 20±2°C of temperature, 45 to 85% relative humidity and 86 to 106kPa of air pressure. Unless otherwise specified, all the tests are conducted under the "standard condition."														
11. Insulation resistance : between wires	100MΩ min.					SMD inductor : Applied voltage : 100VDC Duration : 60sec.  Common mode choke coil : Applied voltage : Rated voltage Duration : 60 sec.									
12. Insulation resistance : between wire and core	100MΩ min.					SMD inductor : Applied voltage : 100VDC Duration : 60sec.									
13. Rated current	Within the specification														
14. Withstanding voltage : between wires	No abnormality					Common mode choke coil : Applied voltage : Regulation voltage Duration : 60 sec.									
15. Withstanding voltage : between wire and core	No abnormality					SMD inductor : Applied voltage : 500VAC Duration : 60 sec.									
16. Adhesion of terminal electrode	No abnormality					SMD inductor : Set testing jigs perpendicularly to top surface of specimen mounted on printed board, and apply specified static load for 5 sec. Specified static load <table border="1" style="margin-left: 20px;"> <thead> <tr> <th>Type</th> <th>static load</th> </tr> </thead> <tbody> <tr> <td>N08DP</td> <td>10N</td> </tr> <tr> <td>NP04S</td> <td rowspan="2">5N</td> </tr> <tr> <td>N06D</td> </tr> <tr> <td>NP06D</td> <td></td> </tr> </tbody> </table>	Type	static load	N08DP	10N	NP04S	5N	N06D	NP06D	
Type	static load														
N08DP	10N														
NP04S	5N														
N06D															
NP06D															
17. Resitance to vibration	Impedance change : Within : ±5%	Refer to individual specification.				SMD inductor, Common mode choke coil : Accoding to JIS C0040 Directions : 2 hrs each in X, Y, and Z directions. Total : 6 hrs Frequency range : 10 to 55 to 10 Hz (1 min.) Amplitude : 1.5mm (Shall not exceed acceleration 196m/s <sup>2</sup> ) Mounting method : soldering onto printed board Recovery : At least 2 hrs of recovery under the standard condition after the test, followed by the measurement within 24 hrs.  A kind of vibration : A									
18. Solderability	95% or more of mounting terminal side shall be covered with tresh solder.	At least 75% of terminal electrode is covered by new solder.				SMD inductor Solder temperature : 230±5°C Duration : 2±0.5 sec. Immersion depth : All sides of mounting terminal shall be immersed.  Common mode choke coil : <table border="1" style="margin-left: 20px;"> <thead> <tr> <th colspan="2">CM04RC - BU05MC</th> </tr> </thead> <tbody> <tr> <td>Solder temperature</td> <td>235±5°C</td> </tr> <tr> <td>Duration</td> <td>2±0.5 sec.</td> </tr> <tr> <td>Immersion depth</td> <td>Up to 0.5mm from terminal root</td> </tr> </tbody> </table>	CM04RC - BU05MC		Solder temperature	235±5°C	Duration	2±0.5 sec.	Immersion depth	Up to 0.5mm from terminal root	
CM04RC - BU05MC															
Solder temperature	235±5°C														
Duration	2±0.5 sec.														
Immersion depth	Up to 0.5mm from terminal root														

Item	Specified Value					Test Method and Remarks																																																				
	Surface Mount High current inductors 08 Type	Surface Mount High current inductors 04/05/06 Type	CommonMode Choke Coils CM04RC	CommonMode Choke Coils BU05MC	Balun Transformers BU05MC																																																					
19. Resistance to soldering heat	No abnormality		Refer to individual specification.			<p>SMD inductor (Reflow soldering)</p> <table border="1"> <tr> <td>Temperature range</td> <td>150~180°C</td> <td>180°Cmin</td> <td>200°Cmin</td> <td>Peak temperature 230°Cmax</td> </tr> <tr> <td>Duration</td> <td>110sec max</td> <td>40sec max</td> <td>30sec max</td> <td></td> </tr> </table> <p>Recommended reflow conditions</p> <p>Recovery : At least 2 hrs of recovery under the standard condition after the removal from test chamber, followed by the measurement within 24 hrs.</p> <p>Common mode choke coil :</p> <p>① Reflow soldering</p> <p>Preheating : 100 to 150°C 1 to 2min.                      Peak : 230 to 240°C Within 5sec.                      More than 200°C Within 40 sec.                      Number of reflow : Within 2 times.</p> <p>② Manual soldering</p> <p>Solder temperature : 350±5°C                      Duration : 3±1sec.                      Recovery : 1 to 2 hrs of recovery under the standard condition after the test.</p>	Temperature range	150~180°C	180°Cmin	200°Cmin	Peak temperature 230°Cmax	Duration	110sec max	40sec max	30sec max																																											
Temperature range	150~180°C	180°Cmin	200°Cmin	Peak temperature 230°Cmax																																																						
Duration	110sec max	40sec max	30sec max																																																							
20. Thermal shock	Inductance change : Within : ±10%		Refer to individual specification.			<p>SMD inductor</p> <p>According to JIS C0025</p> <p>SMD inductor(08 type)</p> <table border="1"> <thead> <tr> <th colspan="3">Conditions of 1 cycle</th> </tr> <tr> <th>Step</th> <th>Temperature(°C)</th> <th>Duration(min)</th> </tr> </thead> <tbody> <tr> <td>1</td> <td>-25<sup>+0</sup><sub>-3</sub></td> <td>30±3</td> </tr> <tr> <td>2</td> <td>Room temperature</td> <td>Within 3</td> </tr> <tr> <td>3</td> <td>+85<sup>+2</sup><sub>-0</sub></td> <td>30±3</td> </tr> <tr> <td>4</td> <td>Room temperature</td> <td>Within 3</td> </tr> </tbody> </table> <p>SMD inductor(04, 05, 06 type)</p> <table border="1"> <thead> <tr> <th colspan="3">Conditions of 1 cycle</th> </tr> <tr> <th>Step</th> <th>Temperature(°C)</th> <th>Duration(min)</th> </tr> </thead> <tbody> <tr> <td>1</td> <td>-25<sup>+0</sup><sub>-3</sub></td> <td>30±3</td> </tr> <tr> <td>2</td> <td>Room temperature</td> <td>Within 3</td> </tr> <tr> <td>3</td> <td>+105<sup>+2</sup><sub>-0</sub></td> <td>30±3</td> </tr> <tr> <td>4</td> <td>Room temperature</td> <td>Within 3</td> </tr> </tbody> </table> <p>Number of cycle : 10 cycles</p> <p>Recovery : At least 2 hrs of recovery under the standard condition after the removal from test chamber, followed by the measurement within 24 hrs.</p> <p>Common mode choke coil :</p> <p>According to JIS C0025</p> <p>Conditions of 1 cycle</p> <table border="1"> <thead> <tr> <th rowspan="2"></th> <th>Temperature(°C)</th> <th rowspan="2">Duration(min)</th> </tr> <tr> <th>CM04RC · BU05MC</th> </tr> </thead> <tbody> <tr> <td>1</td> <td>-25±3°C</td> <td>30±3</td> </tr> <tr> <td>2</td> <td>Room temperature</td> <td>3</td> </tr> <tr> <td>3</td> <td>85±2°C</td> <td>30±3</td> </tr> <tr> <td>4</td> <td>Room temperature</td> <td>3</td> </tr> </tbody> </table> <p>Number of cycle : 10 cycles</p> <p>Recovery : 1~2 hrs of recovery under the standard condition after removal from test chamber.</p>	Conditions of 1 cycle			Step	Temperature(°C)	Duration(min)	1	-25 <sup>+0</sup> <sub>-3</sub>	30±3	2	Room temperature	Within 3	3	+85 <sup>+2</sup> <sub>-0</sub>	30±3	4	Room temperature	Within 3	Conditions of 1 cycle			Step	Temperature(°C)	Duration(min)	1	-25 <sup>+0</sup> <sub>-3</sub>	30±3	2	Room temperature	Within 3	3	+105 <sup>+2</sup> <sub>-0</sub>	30±3	4	Room temperature	Within 3		Temperature(°C)	Duration(min)	CM04RC · BU05MC	1	-25±3°C	30±3	2	Room temperature	3	3	85±2°C	30±3	4	Room temperature	3
Conditions of 1 cycle																																																										
Step	Temperature(°C)	Duration(min)																																																								
1	-25 <sup>+0</sup> <sub>-3</sub>	30±3																																																								
2	Room temperature	Within 3																																																								
3	+85 <sup>+2</sup> <sub>-0</sub>	30±3																																																								
4	Room temperature	Within 3																																																								
Conditions of 1 cycle																																																										
Step	Temperature(°C)	Duration(min)																																																								
1	-25 <sup>+0</sup> <sub>-3</sub>	30±3																																																								
2	Room temperature	Within 3																																																								
3	+105 <sup>+2</sup> <sub>-0</sub>	30±3																																																								
4	Room temperature	Within 3																																																								
	Temperature(°C)	Duration(min)																																																								
	CM04RC · BU05MC																																																									
1	-25±3°C	30±3																																																								
2	Room temperature	3																																																								
3	85±2°C	30±3																																																								
4	Room temperature	3																																																								



Item	Specified Value					Test Method and Remarks										
	Surface Mount High current inductors 08 Type	Surface Mount High current inductors 04/05/06 Type	CommonMode Choke Coils CM04RC	CommonMode Choke Coils BU05MC	Balun Transformers BU05MC											
21.Damp heat (steady state)			Refer to individual specification.			Commom mode choke coil : <table border="1"> <tr> <td></td> <td>CM04RC · BU05MC</td> </tr> <tr> <td>Temperature</td> <td>40±2℃</td> </tr> <tr> <td>Humidity</td> <td>90~95%</td> </tr> <tr> <td>Duration</td> <td>1000±24</td> </tr> </table>		CM04RC · BU05MC	Temperature	40±2℃	Humidity	90~95%	Duration	1000±24		
	CM04RC · BU05MC															
Temperature	40±2℃															
Humidity	90~95%															
Duration	1000±24															
22.Loading under damp heat	Inductance change : Within : ±10%		Refer to individual specification.			SMD inductor : Temperature : 40±2℃ Humidity : 90~95% Applied current : Rated current Duration : 240±2hrs Recovery : At least 2 hrs of recvery under the standard condition after rhe removal from test chamber, followed by the measurement within 24 hrs. Commom mode choke coil : <table border="1"> <tr> <td></td> <td>CM04RC · BU05MC</td> </tr> <tr> <td>Temperature</td> <td>40±2℃</td> </tr> <tr> <td>Humidity</td> <td>90~95%</td> </tr> <tr> <td>Applied current</td> <td>Rated current</td> </tr> <tr> <td>Duration</td> <td>1000±24</td> </tr> </table> Recovery : 1~2 hrs of recovery under the standard condition after the removed from test chamber		CM04RC · BU05MC	Temperature	40±2℃	Humidity	90~95%	Applied current	Rated current	Duration	1000±24
	CM04RC · BU05MC															
Temperature	40±2℃															
Humidity	90~95%															
Applied current	Rated current															
Duration	1000±24															
23.High temperature life test	Inductance change : Within : ±10%		Refer to individual specification.			SMD inductor : Temperature : SMD inductor : 105±3℃ Duration : SMD inductor : 240±2hrs Recovery : At least 2 hrs of recvery under the standard condition after rhe removal from test chamber, followed by the measurement within 24 hrs. Commom mode choke coil : <table border="1"> <tr> <td></td> <td>CM04RC · BU05MC</td> </tr> <tr> <td>Temperature</td> <td>85±2℃</td> </tr> <tr> <td>Duration</td> <td>1000±24</td> </tr> </table> Recovery : 1~2 hrs of recovery under the standard condition after the removed from test chamber		CM04RC · BU05MC	Temperature	85±2℃	Duration	1000±24				
	CM04RC · BU05MC															
Temperature	85±2℃															
Duration	1000±24															
24.Low Temperature life Test	Inductance change : Within : ±10%		Refer to individual specification.			SMD inductor : Temperature : -40±3℃ Duration : SMD inductor : 240±2hrs Recovery : At least 2 hrs of recvery under the standard condition after rhe removal from test chamber, followed by the measurement within 24 hrs. Commom mode choke coil : <table border="1"> <tr> <td></td> <td>CM04RC · BU05MC</td> </tr> <tr> <td>Temperature</td> <td>-40±3℃</td> </tr> <tr> <td>Duration</td> <td>1000±24</td> </tr> </table> Recovery : 1~2 hrs of recovery under the standard condition after the removed from test chamber		CM04RC · BU05MC	Temperature	-40±3℃	Duration	1000±24				
	CM04RC · BU05MC															
Temperature	-40±3℃															
Duration	1000±24															

# PRECAUTIONS

SMD Inductors, CM04RC, BU05MC

Stages	Precautions	Technical considerations
1.Circuit Design	<p>Operating environment,</p> <p>1.The products described in this specification are intended for use in general electronic equipment,(office supply equipment, telecommunications systems, measuring equipment, and household equipment). They are not intended for use in mission-critical equipment or systems requiring special quality and high reliability (traffic systems, safety equipment, aerospace systems, nuclear control systems and medical equipment including life-support systems,) where product failure might result in loss of life, injury or damage. For such uses, contact TAIYO YUDEN Sales Department in advance.</p>	
2.PCB Design	<p>Land pattern design</p> <p>1.Please contact any of our offices for a land pattern, and refer to a recommended land pattern of specifications.</p>	
3.Considerations for automatic placement	<p>Adjustment of mounting machine</p> <p>1.Excessive impact load should not be imposed on the products when mounting onto the PC boards.</p> <p>2.Mounting and soldering conditions should be checked beforehand.</p>	<p>1. When installing products, care should be taken not to apply distortion stress as it may deform the products.</p>
4.Soldering	<p>Reflow soldering</p> <p>1.Please contact any of our offices for a reflow soldering, and refer to the recommended condition specified.</p> <p>2.This products is reflow soldering only.</p> <p>3.SMD Inductors</p> <p>Please do not add any stress to a product until it returns in normal temperature after reflow soldering.</p> <p>Lead free soldering</p> <p>1.When using products with lead free soldering, we request to use them after confirming of adhesion, temperature of resistance to soldering heat, soldering etc sufficiently.</p> <p>Recommended conditions for using a soldering iron:</p> <p>Put the soldering iron on the land-pattern. Soldering iron's temperature - Below 350 °C Duration - 3 seconds or less The soldering iron should not directly touch the inductor.</p>	<p>1.If products are used beyond the range of the recommended conditions, heat stresses may deform the products, and consequently degrade the reliability of the products.</p>
5.Cleaning	<p>Cleaning conditions</p> <p>1.SMD Inductors</p> <p>Please contact any of our offices for a cleaning,</p>	
6.Handling	<p>Handling</p> <p>1.Keep the product away from all magnets and magnetic objects.</p> <p>Breakaway PC boards (splitting along perforations)</p> <p>1.When splitting the PC board after mounting product, care should be taken not to give any stresses of deflection or twisting to the board.</p> <p>2.Board separation should not be done manually, but by using the appropriate devices.</p> <p>Mechanical considerations</p> <p>1.Please do not give the product any excessive mechanical shocks.</p> <p>2.SMD Inductors</p> <p>Please do not add any shock and power to a product in transportation.</p> <p>Pick-up pressure</p> <p>1.SMD Inductors</p> <p>Please do not push to add any pressure to a winding part.</p> <p>Please do not give any shock and push into a ferrite core exposure part.</p> <p>Packing</p> <p>1.SMD Inductors</p> <p>Please avoid accumulation of a packing box as much as possible.</p>	<p>1.There is a case that a characteristic varies with magnetic influence.</p> <p>1.Planning pattern configurations and the position of products should be carefully performed to minimize stress.</p> <p>1.There is a case to be damaged by a mechanical shock.</p> <p>2.SMD Inductors</p> <p>There is a case to be broken by the handling in transportation.</p> <p>1.SMD Inductors</p> <p>Damage and a characteristic can vary with an excessive shock or stress.</p> <p>1.There is a case that transformation and a product of tape are damaged by accumulation of a packing box.</p>
7.Storage conditions	<p>Storage</p> <p>1.To maintain the solderability of terminal electrodes and to keep the packing material in good condition, temperature and humidity in the storage area should be controlled..</p> <p>• Recommended conditions</p> <p>Ambient temperature      0~40°C Humidity                      Below 70% RH</p> <p>The ambient temperature must be kept below 30°C. Even under ideal storage conditions, solderability of products electrodes may decrease as time passes. For this reason, product should be used within one year from the time of delivery.</p> <p>In case of storage over 6 months, solderability shall be checked before actual usage.</p>	<p>1. Under a high temperature and humidity environment, problems such as reduced solderability caused by oxidation of terminal electrodes and deterioration of taping/packaging materials may take place.</p>