

**VTR RF Modulator**

**Description**

CXA1122AP is a VTR RF modulator for the VHF band, and is used to convert frequencies of audio signals and video signals.

This modulator consists of circuits such as video clamp, white clipping, a carrier oscillator, video modulator, audio FM modulator, frequency/channel switch, and antenna switch driver.

**Features**

- Operates with low voltage and low consumption power. ( $V_{cc} = 5\text{ V}$ ,  $I_{cc} = 17.5\text{ mA}$ ,  $I_{cont} = 20\text{ to }25\text{ mA}$ )
- Low radiation and harmonic products.
- Provided with few external devices.
- Permits two channels in the VHF band.
- Provided with a built-in regulator and is resistant to power source changes.
- Allows video input of  $0.5\text{ V}_{p-p}$  and various uses.
- Supports a one-mixer system to simplify the RF unit design.
- Permits the signal ratio of video to audio to be adjusted with an external capacitor.
- Provided with a carrier-off SW function for boss audio.
- Has a built-in antenna switch driver.
- Has a wide oscillation margin for a SAW (Surface Acoustic Wave) resonator.

**Structure**

Bipolar silicon monolithic IC

**Block Diagram**

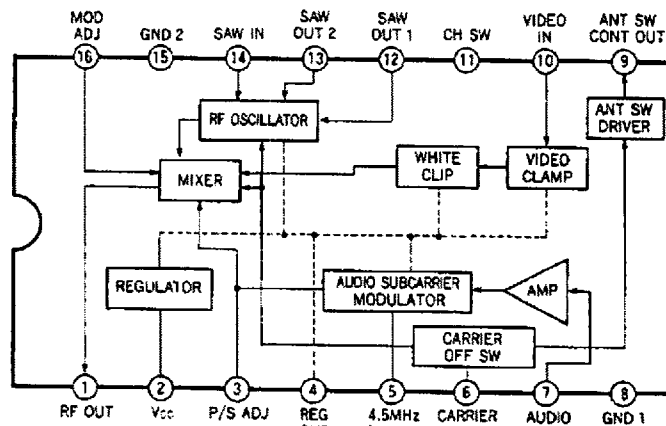

**Package Outline**

Unit: mm

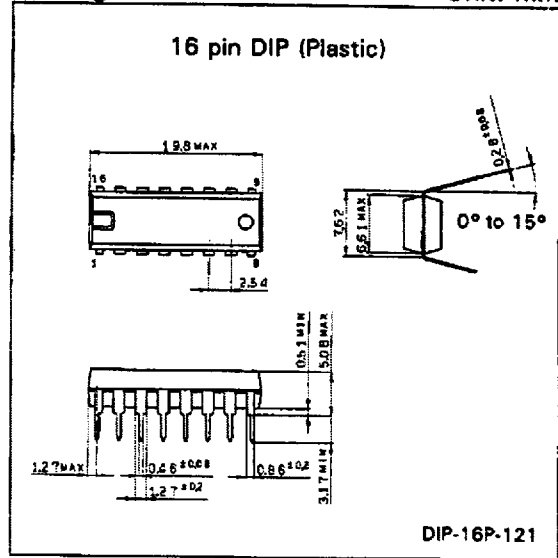

**Absolute Maximum Ratings ( $T_a = 25^\circ\text{C}$ )**

- Supply voltage  $V_{cc}$  12 V
- Operating temperature  $T_{opr}$   $-20\text{ to }+75^\circ\text{C}$
- Storage temperature  $T_{stg}$   $-55\text{ to }+150^\circ\text{C}$
- Allowable power  $P_D$  550 mW dissipation

**Recommended Operating Condition**

- Supply voltage  $V_{cc}$  4.4 to 9.3 V

Pin Description and Equivalent Circuits

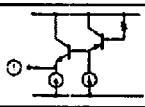
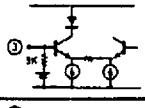
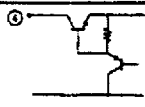
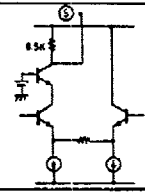
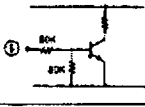
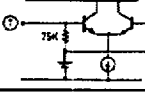
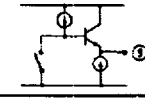
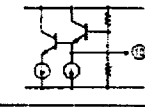
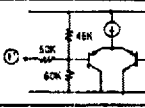
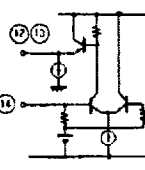
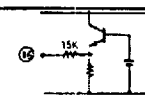
No.	Symbol	Voltage typical value (V)	Equivalent circuit	Description
1	RF OUT	2.9		RF output pin (modulates video and audio FM signals into AM signals and outputs them.)
2	Vcc			Vcc supply voltage pin
3	P/S ADJ	1.8		P/S adjustment pin (The signal ratio of video to audio gets larger as capacitance is added between pin 3 and GND.)
4	REG OUT	3.95		Regulator output pin.
5	4.5 MHz TANK	3.05		Audio tank coil connecting pin
6	CARRIER OFF SW	0		Carrier off switch (OPEN → carrier OFF, Vcc → carrier ON) The RF output can be switched to ON or OFF with the high-impedance input switch.
7	AUDIO IN	1.95		Audio input pin
8	GND1			
9	ANT SW DRIVER	4.0		ON
		0		OFF
10	VIDEO IN	2.6		Video input pin
11	CH SW	2.3		Channel switch OPEN → GND LOW 0 to 0.7V High 2.3 to Vcc
12	SAW OUT1	4.4, 3.7		Output 1 SAW resonator
13	SAW OUT2	3.7, 4.4		Output 2 SAW resonator
14	SAW IN	2.5		Input SAW resonator
15	GND2			
16	MOD ADJ	0.80		Pin for slightly adjusting the modulation depth.

## Electrical Characteristics 1

(See the Electrical Characteristics Test Circuit)

 $T_a = 25^\circ\text{C}$ ,  $V_{cc} = 5\text{ V}$ 

Item	Symbol	Test condition	Min.	Typ.	Max.	Unit
Supply current 1	lcc1	Pin 6 = High	14	17.5	22	mA
Supply current 2	lcc2	Pin 6 = Low	7.5	9.5	12	mA
ANT SW CONT	lcont	Pin 6 = High, lcont = 25 mA load	3.7	4.0	4.3	V
Video output level	Vo(fp1)	$V_1 = \text{No input}$	85.5	88.0	90.5	dB $\mu$
	Vo(fp2)	$V_{o1}$ output level *1				
Video output level temperature stability	$\Delta V_o(fp1)$	$V_o(fp1)$ ( $T_a = -10$ to $+70^\circ\text{C}$ ) – $V_o(fp1)$ ( $T_a = 25^\circ\text{C}$ ) –	–	–	$\pm 2$	dB
	$\Delta V_o(fp2)$	$V_o(fp2)$ ( $T_a = -10$ to $+70^\circ\text{C}$ ) – $V_o(fp1)$ ( $T_a = 25^\circ\text{C}$ )				
Video modulation depth	mp1	$V_1 = 0.5\text{ V}_{p-p}$ WHITE	72	78	84	%
	mp2	$V_o$ modulation depth				
Video modulation depth temperature stability	$\Delta mp1$	mp1 ( $T_a = -10$ to $+70^\circ\text{C}$ ) – mp1 ( $T_a = 25^\circ\text{C}$ )	–	–	$\pm 2.5$	%
	$\Delta mp2$	mp2 ( $T_a = -10$ to $+70^\circ\text{C}$ ) – mp2 ( $T_a = 25^\circ\text{C}$ )				
Video modulation depth difference between channels	$\Delta mp$	mp1 – mp2	–	$\pm 0.2$	$\pm 2$	%
Maximum video modulation depth	$\Delta mp2$ (Max.)	$V_1 = 1.0\text{ V}_{p-p}$ , WHITE $V_o$ modulation depth *2 $\Delta mp2 = mp2 - mp2$ (max) (max)	11.5	15.0	18.5	%
920 kHz beat	Vb	$V_1 = 0.5\text{ V}_{p-p}$ sin 3.58-MHz input *3	64	70	–	dB
Sync-crush level	$\Delta Sync$	$V_1 = 0.5\text{ V}_{p-p}$ , WHITE $V_o$ output $1 - \left( \frac{V_{Sync}}{V_{White}} \right) \times \frac{100}{40}$	–	–	10	%
Differential gain	DG1	$V_1 = 0.5\text{ V}_{p-p}$ , STAIR STEP	–	1	3	%
	DG2	$V_o$ DG *4				
Differential phase	DP1	$V_1 = 0.5\text{ V}_{p-p}$ , STAIR STEP	–	2	5	deg
	DP2	$V_o$ DP *4				
Video higher-harmonic wave ratio	VvH	$V_1 = 0.5\text{ V}_{p-p}$ , 1 MHz CW *5	–	–56	–46	dB
RF carrier ratio of video to audio	Vps	$V_1 = \text{no Video Signal}$ , $C_1 = 3\text{ pF}$	11.5	13.5	15.5	dB
Audio FM Central frequency temperature stability	$\Delta fs$	$S_1 = 1$ , $F_s = V_{o2}$ frequency $fs(T_a = 0$ to $60^\circ\text{C}) - fs(T_a = 25^\circ\text{C})$ *6	–	–	$\pm 10$	kHz
Audio FM modulation sensitivity *	$\beta S$	$S_1 = 1$ , $C_2 = 39\text{ pF}$ $V_2 = \text{pin 7 DC voltage } \pm 0.2\text{ V}$ $fs$ frequency change/ $0.4\text{ V}$ *7	0.445	0.555	0.665	kHz/mV
Audio total harmonic distortion ratio	THD	$S_1 = 1$ , $V_2 = 1\text{ kHz}$ *8	–	0.30	0.8	%
Audio S/N	ASN	The audio S/N is 0 dB at 60% modulation	55	59	–	dB
Maximum audio FM modulation depth	ms(Max.)	$S_1 = 1$ , $V_2 = \text{pin 7 DC voltage } \pm 1.0\text{ V}$ FS frequency change/ $50\text{ kHz} \times 100$	400	–	–	%

**\* Classifications**

Marking	Audio FM modulation sensitivity (kHz/mV)
A1122AP-3	0.665 to 0.577
A1122AP-1	0.595 to 0.515
A1122AP-2	0.533 to 0.445

**Electrical Characteristics 2** (Design security items: This parameter is not 100% tested.)

1. Video S/N	Min. 50 dB Typ. 58 dB
2. Video amplitude frequency characteristic (based on 1 MHz)	Within $\pm 1$ dB for 0.5 to 5 MHz
3. Audio amplitude frequency characteristic (based on 1 kHz)	Within $\pm 1$ dB for 0.1 to 60 kHz

- Note) \*1.** Measure the  $V_o$  output level using the spectrum analyzer with a  $50\Omega$  input impedance and convert measured value  $V_o$  into decibels (dBm) using the following expression:  
 $Output (dB\mu) = V_o (dBm) + 113$
- \*2. The difference in image modulation depth between the maximum modulation depth at an input of 0.5 Vp-p and at an input of 1.0 Vp-p.
  - \*3. Directly-read value (dB) of the component ratio of the 920 kHz beat to the video carrier level measured with a spectrum analyzer
  - \*4. Measured with the standard-type demodulator after demodulation.
  - \*5.  $f_c + 2$  MHz or  $f_c + 3$  MHz level to the  $V_o$  carrier ( $f_c$ ) level
  - \*6. Adjust  $f_s$  to 4.500 MHz with  $T_a = 25^\circ C$ .
  - \*7. A 15 k $\Omega$  resistor is added in series for pre-emphasis so that a better match can be obtained between audio modulation sensitivity classifications.
  - \*8. Adjust the  $V_2$  level so that the FM deviation is  $\pm 15$  kHz and measure the total harmonic distortion after demodulating  $V_o$  with the standard-type demodulator.

**Input Waveforms**

**WHITE signal**

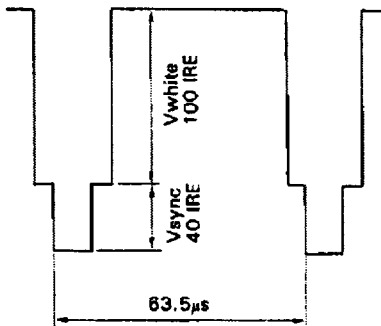

**STAIR STEP signal**

APL 50% subcarrier 20 IRE

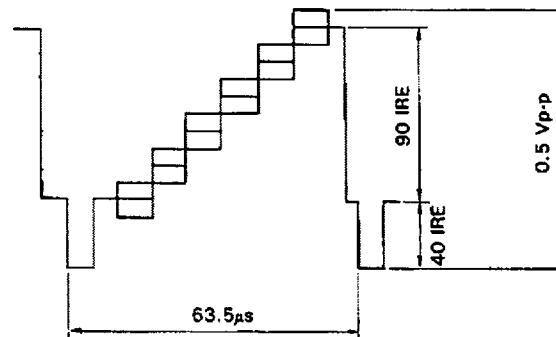

Electrical Characteristics Test Circuit

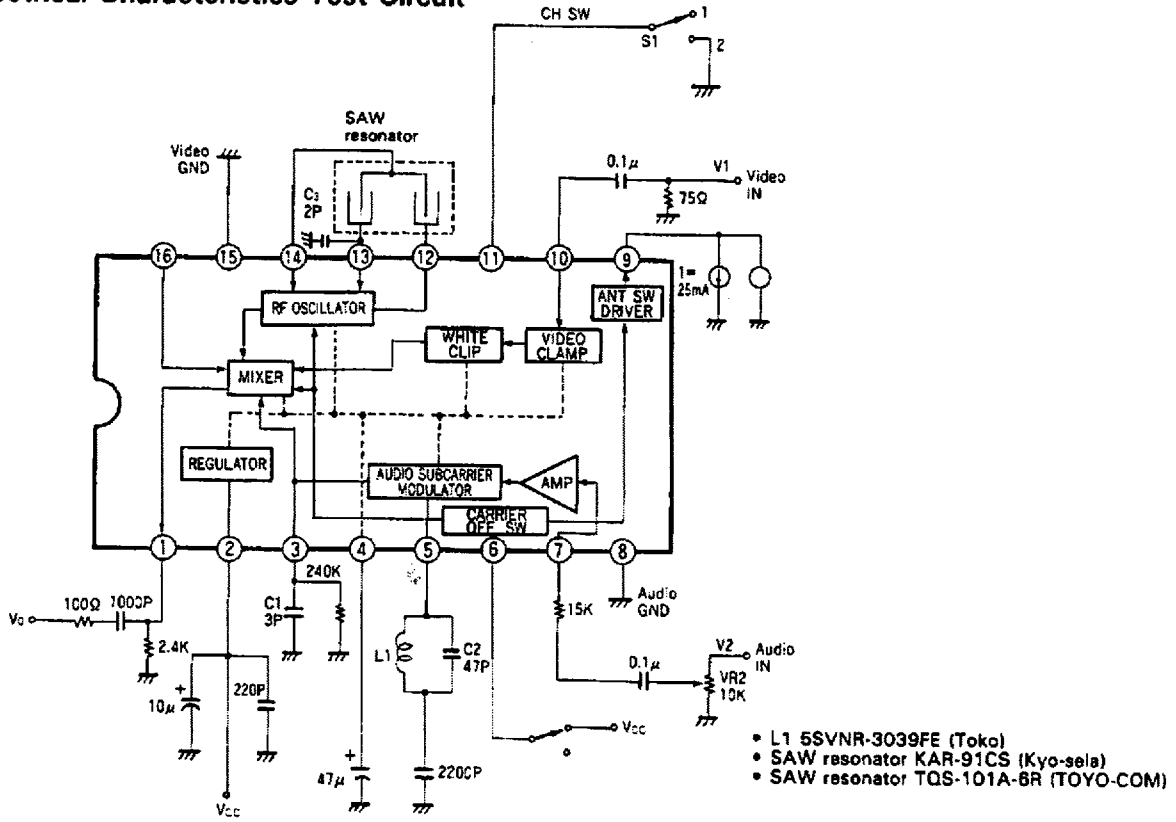

Application Circuit

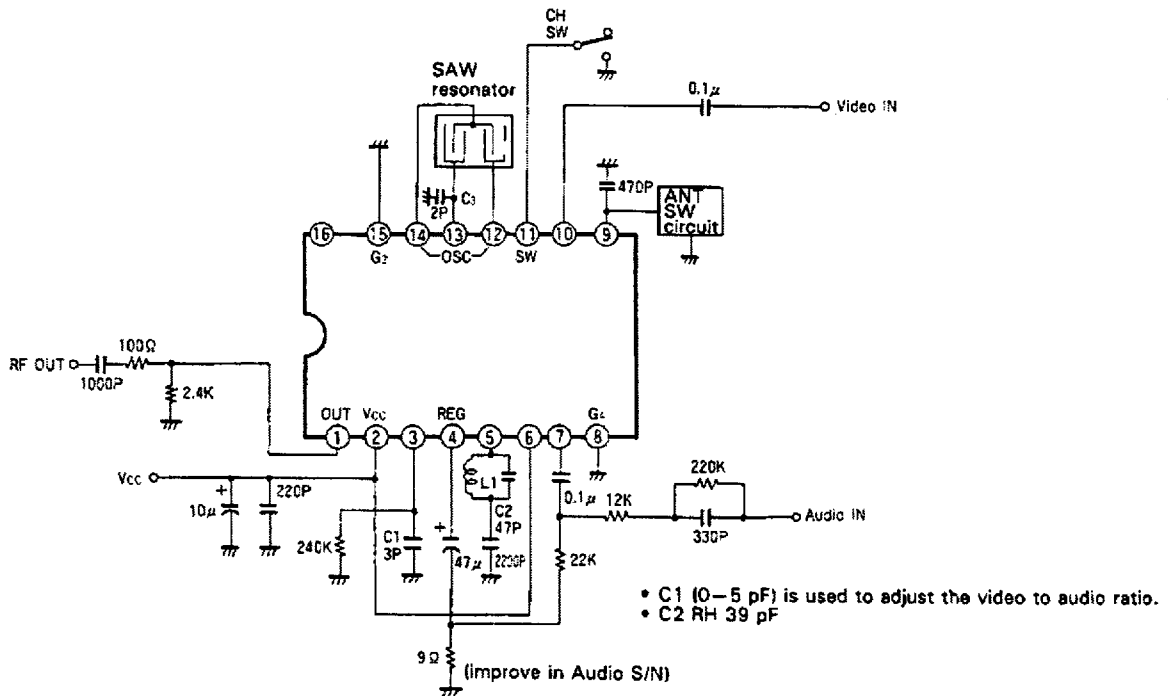

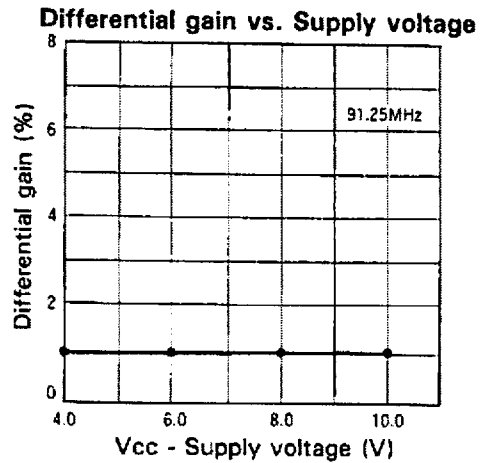
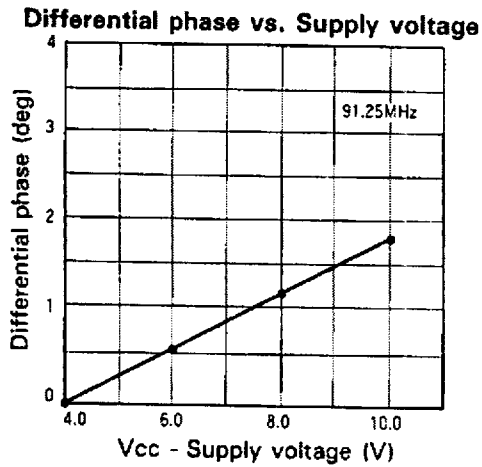
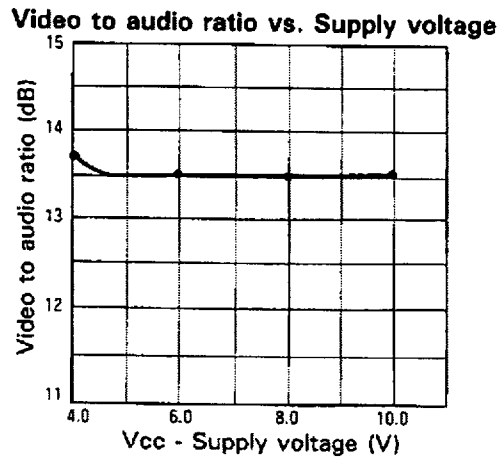
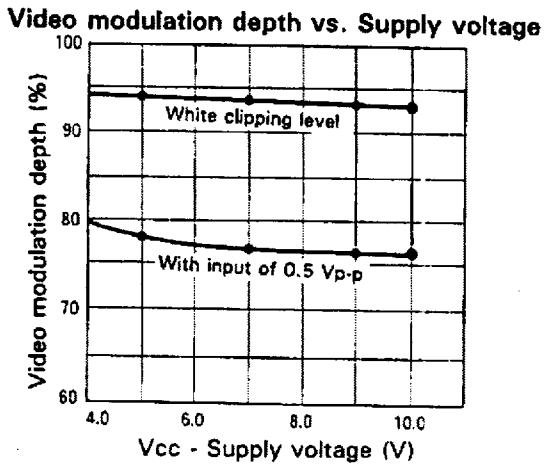
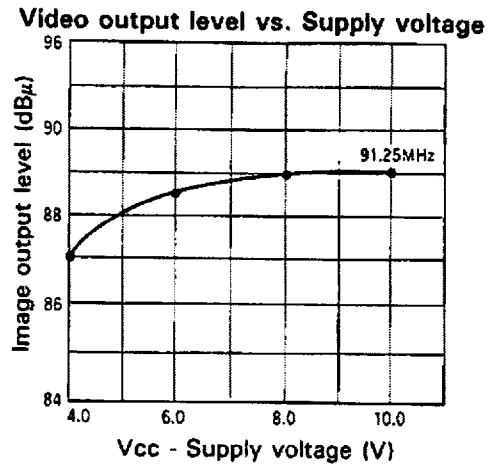
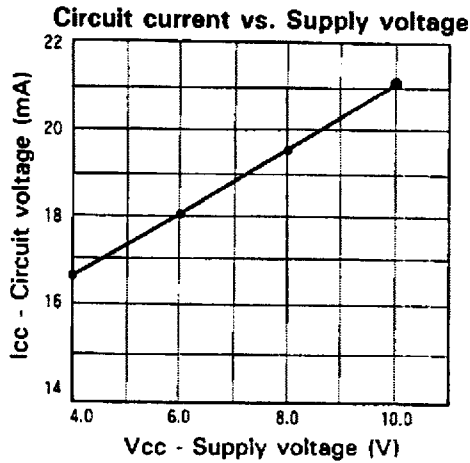

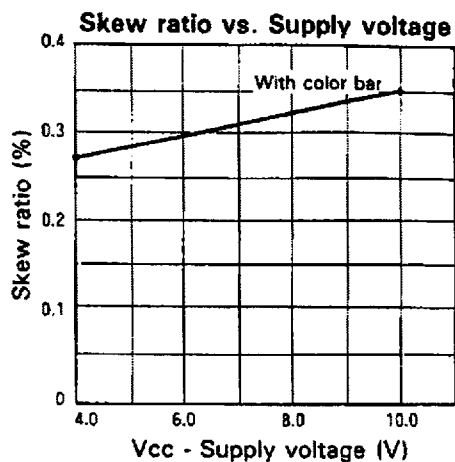
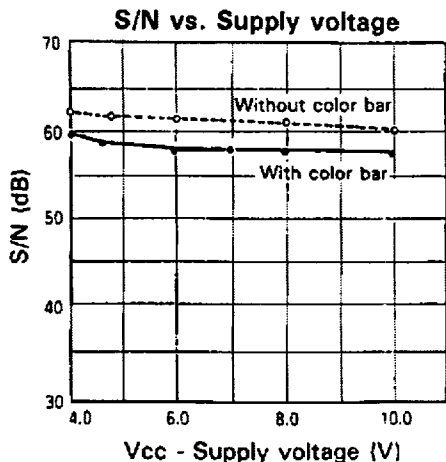

ANT SW driver load vs. Voltage characteristic

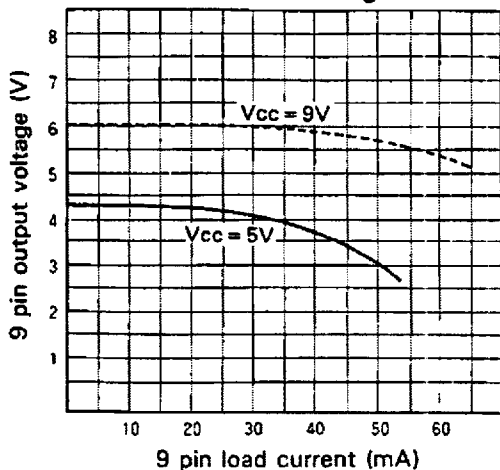

920 kHz beat vs. Supply voltage

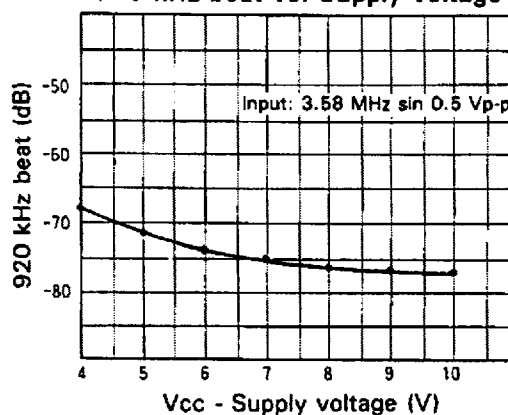

Inter-carrier change vs. Supply voltage

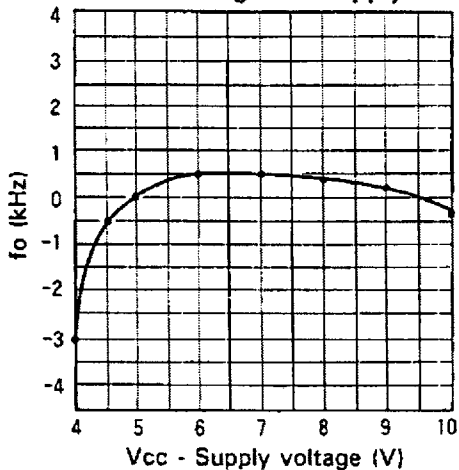

Supply ripple characteristics

Techtronics AA501  
DISTORTION ANALYZER  
Rms measurement

