

General Description

The AAT1150 SwitchReg™ is a member of AnalogicTech's Total Power Management IC™ (TPMIC™) product family. The step-down switching converter is ideal for applications where high efficiency, small size, and low ripple are critical. Able to deliver 1A with internal power MOSFETs, the current-mode controlled IC provides high efficiency using synchronous rectification. Fully internally compensated, the AAT1150 simplifies system design and lowers external parts count.

The AAT1150 is available in an MSOP-8 package and is rated over the -40°C to +85°C temperature range.

Features

- V_{IN} Range: 2.7V to 5.5V
- Up to 95% Efficiency
- 110m Ω $R_{DS(ON)}$ MOSFET Switch
- <1.0 μ A of Shutdown Current
- 1MHz Switching Frequency
- Fixed or Adjustable V_{OUT} : 1.0V to 4.2V
- High Initial Accuracy: $\pm 1\%$
- 1.0A Peak Current
- Integrated Power Switches
- Synchronous Rectification
- Internally Compensated Current Mode Control
- Constant PWM Mode for Low Output Ripple
- Internal Soft Start
- Current Limit Protection
- Over-Temperature Protection
- MSOP-8 package
- -40°C to +85°C Temperature Range

Applications

- Cable/DSL Modems
- Computer Peripherals
- High Efficiency Conversion From 5V or 3.3V Supply
- Network Cards
- Set-Top Boxes

Typical Application

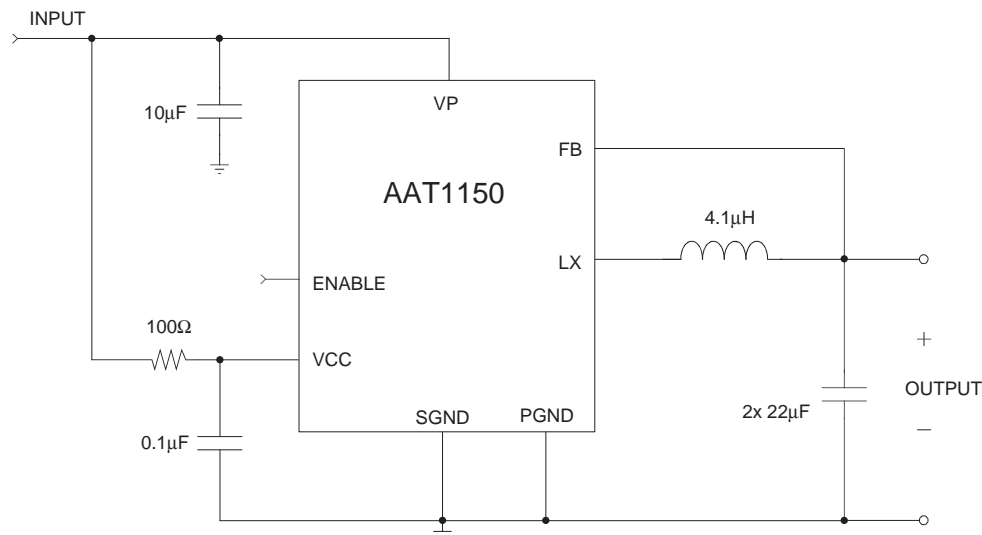

Pin Descriptions

Pin #	Symbol	Function
1	FB	Feedback input pin. This pin must be connected to the converter's output. It is used to set the output of the converter to regulate to the desired value.
2	SGND	Signal ground.
3	EN	Enable input pin. When connected high, the AAT1150 is in normal operation. When connected low, it is powered down. This pin should not be left floating.
4	VCC	Power supply. It supplies power for the internal circuitry.
5	VP	Input supply voltage for converter power stage.
6, 7	LX	Inductor connection pins. These pins should be connected to the output inductor. Internally, Pins 6 and 7 are connected to the drains of the P-channel switch and N-channel synchronous rectifier.
8	PGND	Power ground return for the output stage.

Pin Configuration

**MSOP-8
(Top View)**

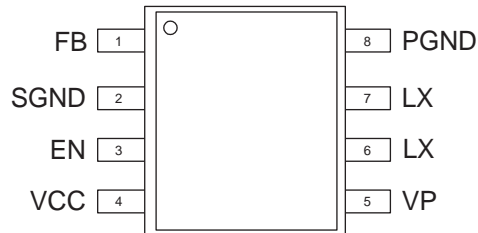

Absolute Maximum Ratings¹

$T_A = 25^\circ\text{C}$, unless otherwise noted.

Symbol	Description	Value	Units
V_{CC}, V_P	V_{CC}, V_P to GND	6	V
V_{LX}	LX to GND	-0.3 to $V_P+0.3$	V
V_{FB}	FB to GND	-0.3 to $V_{CC}+0.3$	V
V_{EN}	EN to GND	-0.3 to 6	V
T_J	Operating Junction Temperature Range	-40 to 150	$^\circ\text{C}$
V_{ESD}	ESD Rating ² - HBM	3000	V

Thermal Characteristics

Symbol	Description	Value	Units
Θ_{JA}	Maximum Thermal Resistance (MSOP-8) ³	150	$^\circ\text{C}/\text{W}$
P_D	Maximum Power Dissipation (MSOP-8, $T_A = 25^\circ\text{C}$) ^{3,4}	667	mW

Recommended Operating Conditions

Symbol	Description	Rating	Units
T	Ambient Temperature Range	-40 to +85	$^\circ\text{C}$

1. Stresses above those listed in Absolute Maximum Ratings may cause permanent damage to the device. Functional operation at conditions other than the operating conditions specified is not implied. Only one Absolute Maximum Rating should be applied at any one time.
2. Human body model is a 100pF capacitor discharged through a 1.5K Ω resistor into each pin.
3. Mounted on a demo board.
4. Derate 6.7mW/ $^\circ\text{C}$ above 25 $^\circ\text{C}$.

Electrical Characteristics

$V_{IN} = V_{CC} = V_P = 5V$, $T_A = -40^\circ\text{C}$ to $+85^\circ\text{C}$, unless otherwise noted. Typical values are at $T_A = 25^\circ\text{C}$.

Symbol	Description	Conditions	Min	Typ	Max	Units
V_{IN}	Input Voltage Range		2.7		5.5	V
V_{OUT}	Output Voltage Tolerance	$V_{IN} = V_{OUT} + 0.3$ to $5.5V$, $I_{OUT} = 0$ to $1A$	-4.0		4.0	%
$\Delta V_{OUT} (V_{OUT} * \Delta V_{IN})$	Load Regulation	$V_{IN} = 4.2V$, $I_{LOAD} = 0 - 1A$		3.0		%
$\Delta V_{OUT}/V_{OUT}$	Line Regulation	$V_{IN} = 2.7$ to $5.5V$		0.2		%/V
V_{UVLO}	Under-Voltage Lockout	V_{IN} Rising			2.5	V
		V_{IN} Falling	1.2			
$V_{UVLO(HYS)}$	Under-Voltage Lockout Hysteresis			250		mV
I_Q	Quiescent Supply Current	No Load, $V_{FB} = 0$		160	300	μA
I_{SHDN}	Shutdown Current	$V_{EN} = 0V$, $V_{IN} = 5.5V$			1.0	μA
I_{LIM}	Current Limit	$T_A = 25^\circ\text{C}$	1.2			A
$R_{DS(ON)H}$	High Side Switch On Resistance	$T_A = 25^\circ\text{C}$		110	150	$\text{m}\Omega$
$R_{DS(ON)L}$	Low Side Switch On Resistance	$T_A = 25^\circ\text{C}$		100	150	$\text{m}\Omega$
η	Efficiency	$V_{IN} = 5V$, $V_{OUT} = 3.3V$, $I_{OUT} = 600\text{mA}$		93		%
$V_{EN(L)}$	Enable Low Voltage	$V_{IN} = 2.7$ to $5.5V$			0.6	V
$V_{EN(H)}$	Enable High Voltage	$V_{IN} = 2.7$ to $5.5V$	1.4			V
I_{EN}	Enable Pin Leakage Current	$V_{EN} = 5.5V$			1.0	μA
F_{OSC}	Oscillator Frequency	$T_A = 25^\circ\text{C}$	700	1000	1200	kHz
T_{SD}	Over-Temperature Shutdown Threshold			140		$^\circ\text{C}$
T_{HYS}	Over-Temperature Shutdown Hysteresis			15		$^\circ\text{C}$

Typical Characteristics

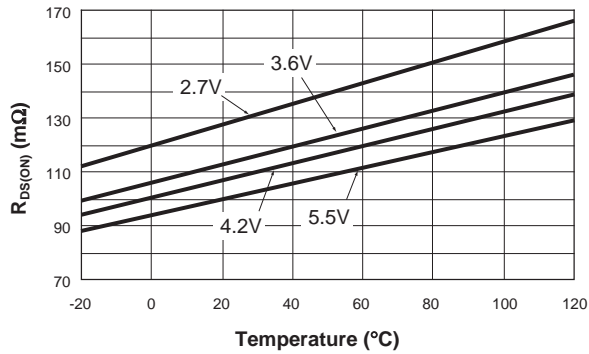
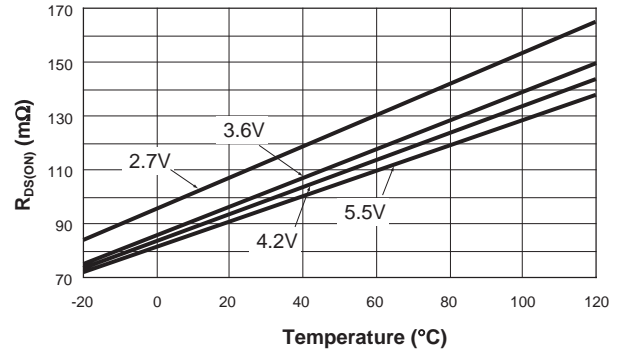
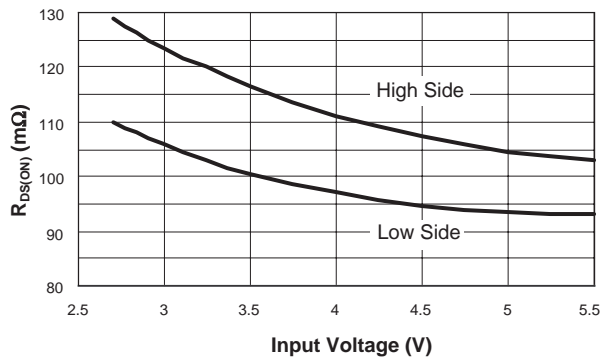
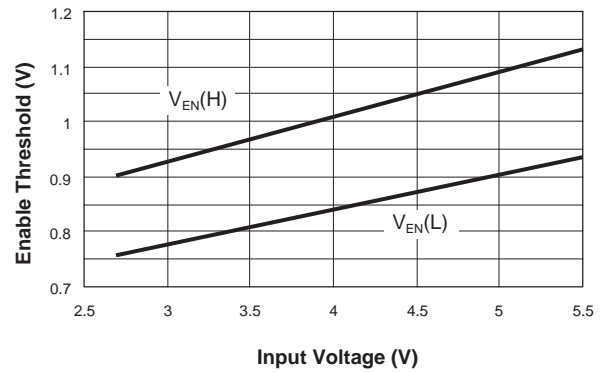
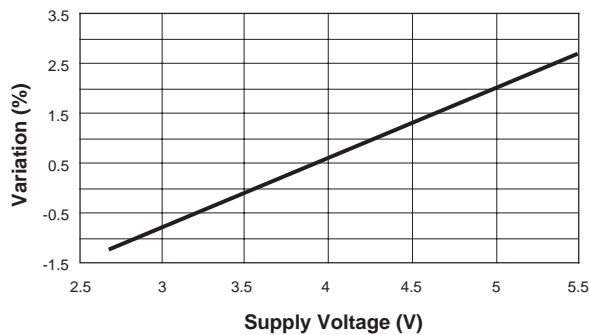
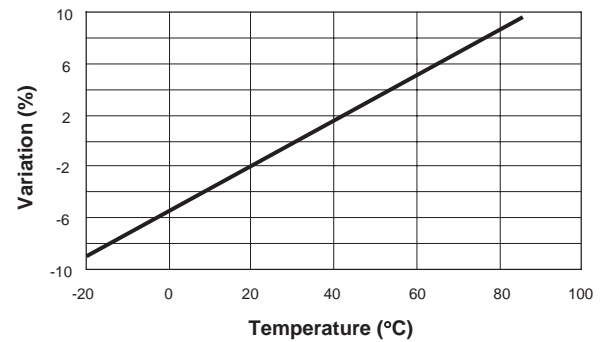
High Side $R_{DS(ON)}$ vs. Temperature

Low Side $R_{DS(ON)}$ vs. Temperature

 $R_{DS(ON)}$ vs. Input Voltage

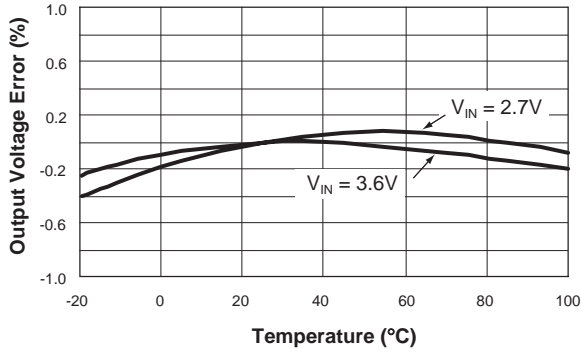
Enable Threshold vs. Input Voltage

Oscillator Frequency Variation vs. Supply Voltage

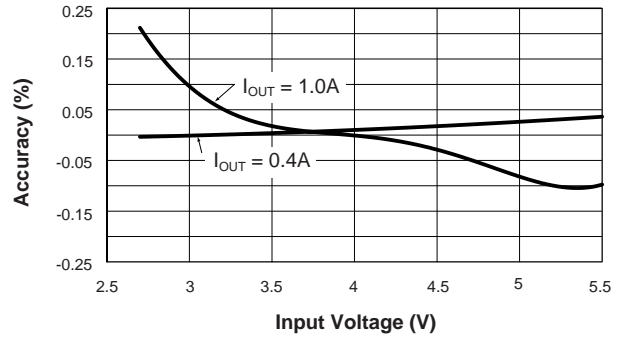
Oscillator Frequency Variation vs. Temperature ($V_{IN} = 3.6V$)

Typical Characteristics

Output Voltage vs. Temperature
($I_{OUT} = 900\text{mA}$; $V_{OUT} = 1.5\text{V}$)



Line Regulation
($V_{OUT} = 1.5\text{V}$)



Load Regulation
($V_{OUT} = 1.5\text{V}$; $V_{IN} = 3.6\text{V}$)

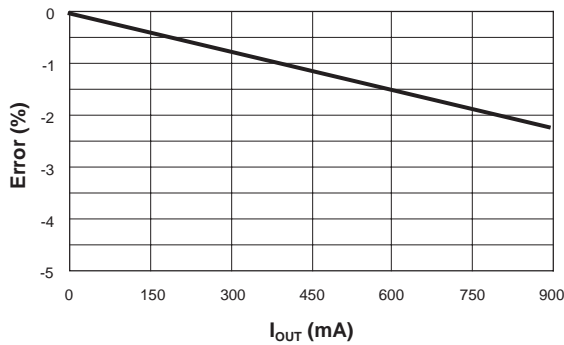

Load Regulation
($V_{OUT} = 3.3\text{V}$; $V_{IN} = 5.0\text{V}$)

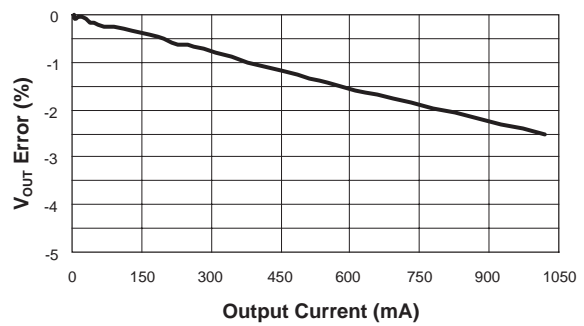

Efficiency vs. Input Voltage
($V_{OUT} = 1.5\text{V}$)

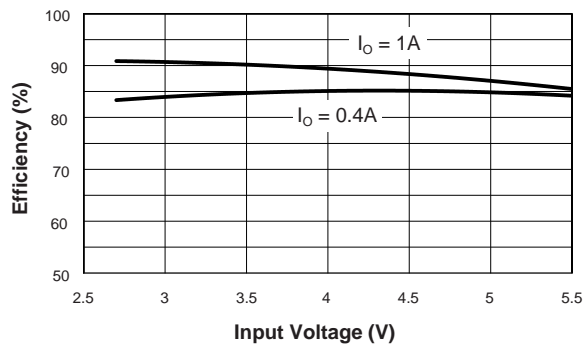

Loop Gain and Phase vs. Output Capacitor
($V_{IN} = 3.6\text{V}$; $I_{OUT} = 0.3\text{A}$; $C_O = 22\mu\text{F}$)

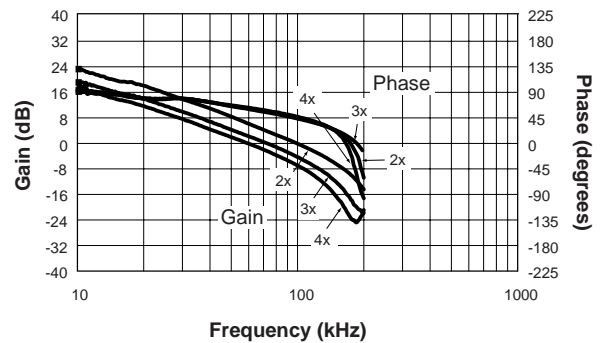

Typical Characteristics

No Load Input Current vs. Temperature
($V_{CC} = V_P$)

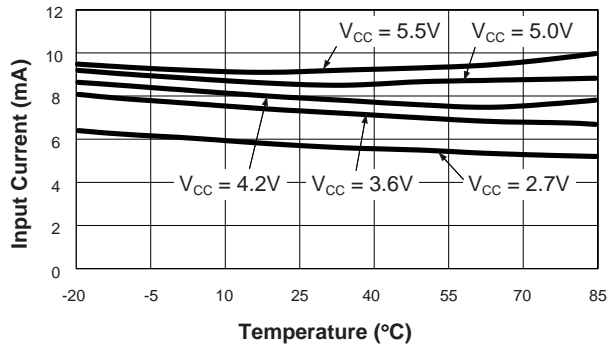

Non-Switching I_Q vs. Temperature
($FB = 0V$; $V_P = V_{CC}$)

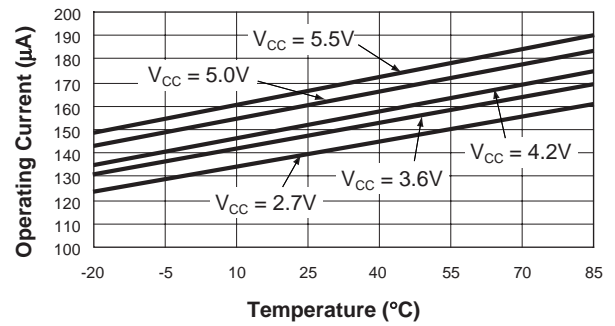

Switching Waveform
($V_{IN} = 3.6V$; $V_{OUT} = 1.5V$; $I_{OUT} = 1.2A$)

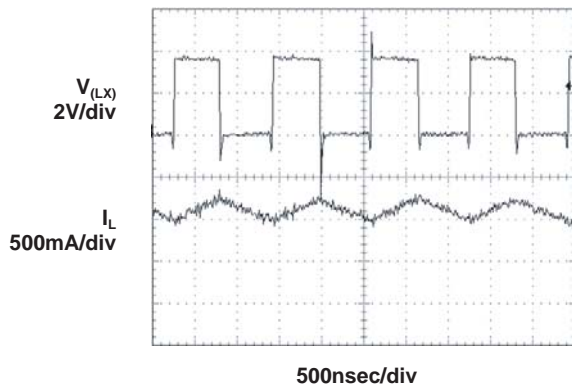

Transient Response
($V_{IN} = 3.6V$; $V_{OUT} = 1.5V$; $I_{LOAD} = 0.25$ to $1.2A$)

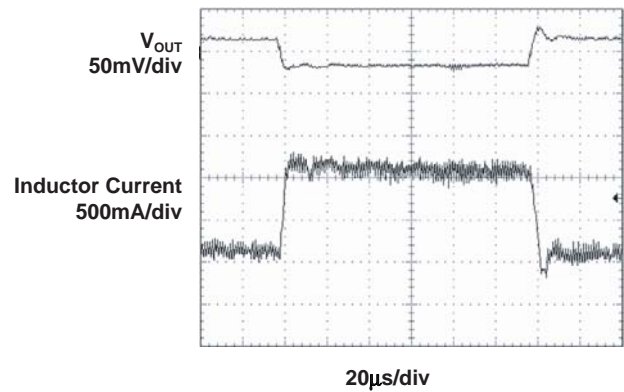

Output Ripple
($V_{IN} = 3.6V$; $V_{OUT} = 1.5V$; $I_{OUT} = 0A$)

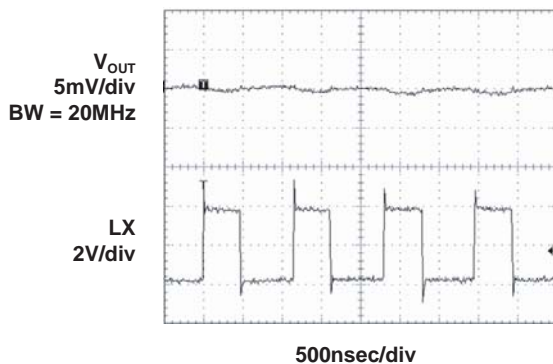

Output Ripple
($V_{IN} = 3.6V$; $V_{OUT} = 1.5V$; $I_{OUT} = 1A$)

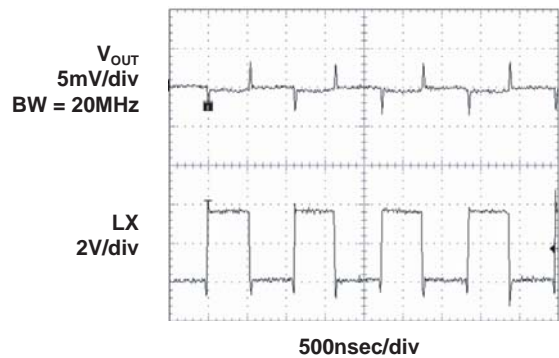

Typical Characteristics

Output Ripple
($V_{IN} = 5.0V$; $V_{OUT} = 3.3V$; $I_{OUT} = 0A$)

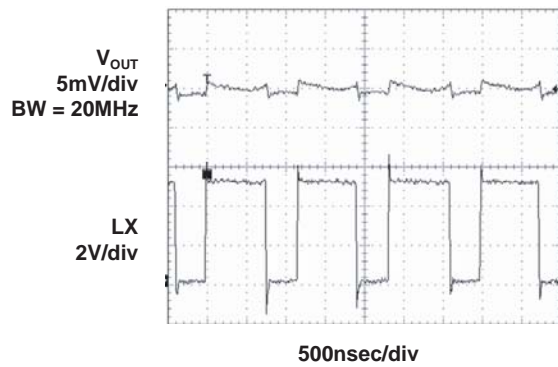

Output Ripple
($V_{IN} = 5.0V$; $V_{OUT} = 3.3V$; $I_{OUT} = 1A$)

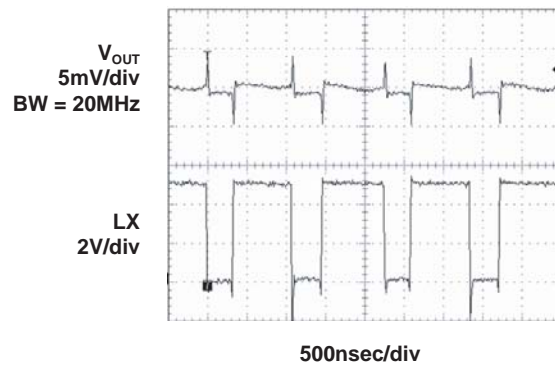

Inrush Limit
($V_{IN} = 3.6V$; $V_{OUT} = 1.5V$; $I_L = 1A$)

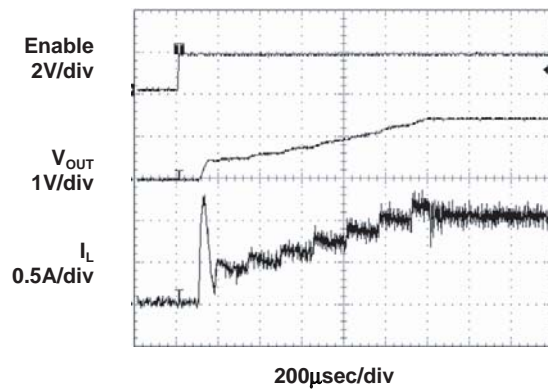

Functional Block Diagram

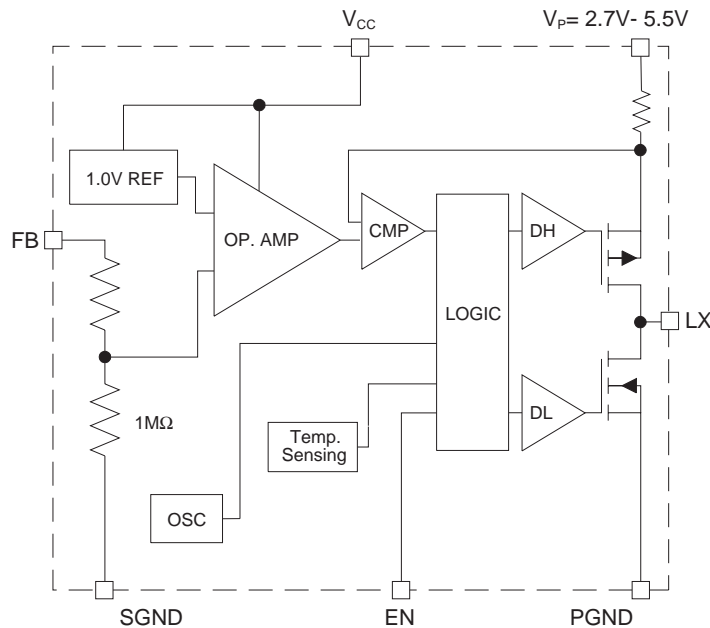

Applications Information

Control Loop

The AAT1150 is a peak current mode buck converter. The inner wide bandwidth loop controls the peak current of the output inductor. The output inductor current is sensed through the P-channel MOSFET (high side) and is also used for short-circuit and overload protection. A fixed slope compensation signal is added to the sensed current to maintain stability. The loop appears as a voltage-programmed current source in parallel with the output capacitor.

The voltage error amplifier output programs the current loop for the necessary inductor current to force a constant output voltage for all load and line conditions. The feedback resistive divider is inter-

nal, dividing the output voltage to the error amplifier reference voltage of 1.0V. The error amplifier does not have a large DC gain typical of most error amplifiers. This eliminates the need for external compensation components while still providing sufficient DC loop gain for load regulation. The crossover frequency and phase margin are set by the output capacitor value only.

Soft Start/Enable

Soft start increases the inductor current limit point in discrete steps when the input voltage or enable input is applied. It limits the current surge seen at the input and eliminates output voltage overshoot. The enable input, when pulled low, forces the AAT1150 into a low power, non-switching state. The total input current during shutdown is less than 1μA.

Power and Signal Source

Separate small signal ground and power supply pins isolate the internal control circuitry from the noise associated with the output MOSFET switching. The low pass filter R1 and C3 in schematic Figures 1 and 2 filters the noise associated with the power switching.

Current Limit and Over-Temperature Protection

For overload conditions, the peak input current is limited. Figure 3 displays the VI current limit characteristics. As load impedance decreases and the output voltage falls closer to zero, more power is dissipated internally, raising the device temperature. Thermal protection completely disables switching when internal dissipation becomes excessive, protecting the device from damage. The junction over-temperature threshold is 140°C with 15°C of hysteresis.

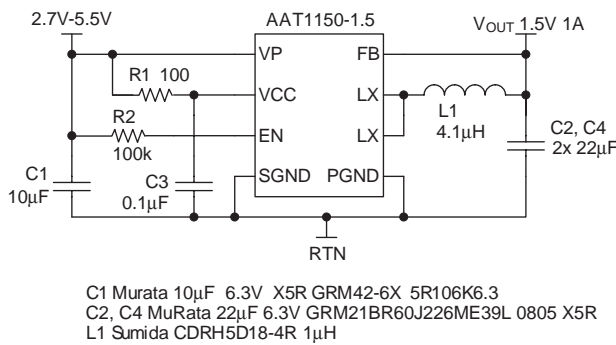

Figure 1: Lithium-Ion to 1.5V Converter.

1.5V Efficiency vs. I_{OUT}

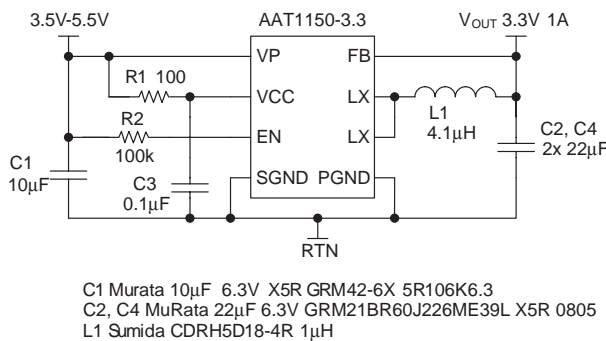
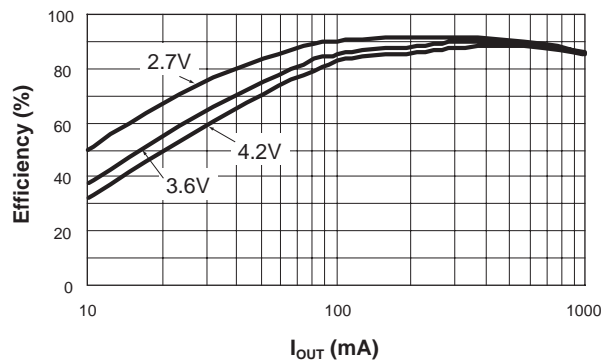
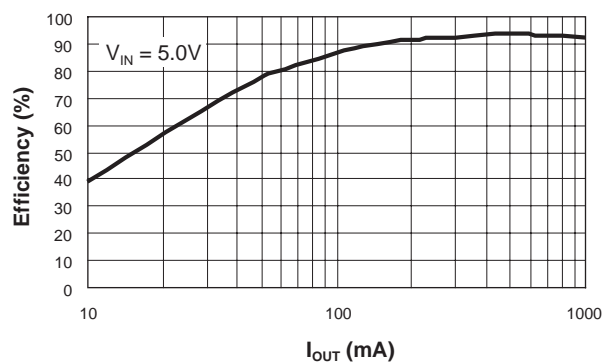

Figure 2: 5V Input to 3.3V Output Converter.

3.3 Volt Efficiency vs. I_{OUT}



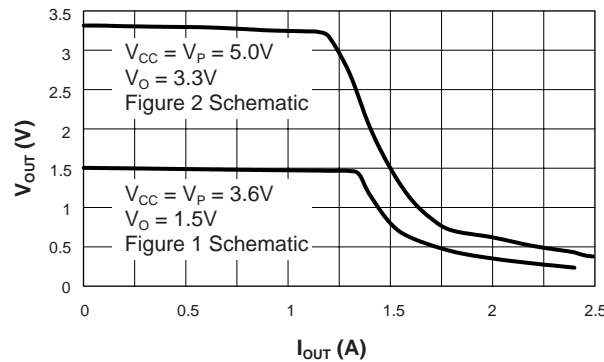

Figure 3: Current Limit Characteristic.

Inductor

The output inductor is selected to limit the ripple current to some predetermined value, typically 20% to 40% of the full load current at the maximum input voltage. Manufacturer's specifications list both the inductor DC current rating, which is a thermal limitation, and the peak current rating, which is determined by the saturation characteristics. The inductor should not show any appreciable saturation under normal load conditions. During overload and short-circuit conditions, the average current in the inductor can meet or exceed the I_{LIMIT} point of the AAT1150 without affecting converter performance. Some inductors may have sufficient peak and average current ratings yet result in excessive losses due to a high DCR. Always consider the losses associated with the DCR and its effect on the total converter efficiency when selecting an inductor.

For a 1.0A load and the ripple set to 30% at the maximum input voltage, the maximum peak-to-peak ripple current is 300mA. The inductance value required is 3.9 μ H.

$$L = \frac{V_{OUT}}{I_o \cdot k \cdot F} \cdot \left(1 - \frac{V_{OUT}}{V_{IN}}\right)$$

$$L = \frac{1.5V}{1.0A \cdot 0.3 \cdot 830kHz} \cdot \left(1 - \frac{1.5V}{4.2V}\right)$$

$$L = 3.9\mu H$$

The factor "k" is the fraction of full load selected for the ripple current at the maximum input voltage. The corresponding inductor RMS current is:

$$I_{RMS} = \sqrt{\left(I_o^2 + \frac{\Delta I^2}{12}\right)} \approx I_o = 1.0A$$

ΔI is the peak-to-peak ripple current which is fixed by the inductor selection above. For a peak-to-peak current of 30% of the full load current, the peak current at full load will be 115% of the full load. The 4.1 μ H inductor selected from the Sumida CDRH5D18 series has a 57m Ω DCR and a 1.95A DC current rating. At full load, the inductor DC loss is 57mW which amounts to a 3.8% loss in efficiency.

Input Capacitor

The primary function of the input capacitor is to provide a low impedance loop for the edges of pulsed current drawn by the AAT1150. A low ESR/ESL ceramic capacitor is ideal for this function. To minimize stray inductance, the capacitor should be placed as closely as possible to the IC. This keeps the high frequency content of the input current localized, minimizing radiated and conducted EMI while facilitating optimum performance of the AAT1150. Ceramic X5R or X7R capacitors are ideal for this function. The size required will vary depending on the load, output voltage, and input voltage source impedance characteristics. A typical value is around 10 μ F. The input capacitor RMS

current varies with the input voltage and the output voltage. The equation for the RMS current in the input capacitor is:

$$I_{RMS} = I_O \cdot \sqrt{\frac{V_O}{V_{IN}} \cdot \left(1 - \frac{V_O}{V_{IN}}\right)}$$

The input capacitor RMS ripple current reaches a maximum when V_{IN} is two times the output voltage where it is approximately one half of the load current. Losses associated with the input ceramic capacitor are typically minimal and are not an issue. Proper placement of the input capacitor can be seen in the reference design layout shown in Figures 4 and 5.

Output Capacitor

Since there are no external compensation components, the output capacitor has a strong effect on loop stability. Larger output capacitance will reduce the crossover frequency with greater phase margin. For the 1.5V 1.0A design using the 4.1 μ H inductor, two 22 μ F capacitors provide a stable output. In addition to assisting stability, the output capacitor limits the output ripple and provides holdup during large load transitions.

The output capacitor RMS ripple current is given by:

$$I_{RMS} = \frac{1}{2 \cdot \sqrt{3}} \cdot \frac{V_{OUT} \cdot (V_{IN} - V_{OUT})}{L \cdot F \cdot V_{IN}}$$

For a ceramic capacitor, the dissipation due to the RMS current of the capacitor is not a concern. Tantalum capacitors, with sufficiently low ESR to meet output voltage ripple requirements, also have an RMS current rating much greater than that actually seen in this application.

Adjustable Output

For applications requiring an output other than the fixed outputs available, the 1V version can be programmed externally (see Figure 6). Resistors R3 and R4 force the output to regulate higher than 1V. R4 should be 100 times less than the internal 1m Ω resistance of the FB pin. Once R4 is selected, R3 can be calculated. For a 1.25V output with R4 set to 10k Ω , R3 is 2.55k Ω .

$$R3 = (V_O - 1) \cdot R4 = 0.25 \cdot 10.0k\Omega = 2.55k\Omega$$

Layout Considerations

Figures 4 and 5 display the suggested PCB layout for the AAT1150. The most critical aspect of the layout is the placement of the input capacitor C1. For proper operation, C1 must be placed as closely as possible to the AAT1150.

Thermal Calculations

There are two types of losses associated with the AAT1150 output switching MOSFET: switching losses and conduction losses. Conduction losses are associated with the $R_{DS(ON)}$ characteristics of the output switching device. At full load, assuming continuous conduction mode (CCM), a simplified form of the total losses is:

$$P_{LOSS} = \frac{I_O^2 \cdot (R_{DS(ON)(H)} \cdot V_O + R_{DS(ON)(L)} \cdot (V_{IN} - V_O))}{V_{IN}} + t_{sw} \cdot F \cdot I_O \cdot V_{IN} + I_Q \cdot V_{IN}$$

Once the total losses have been determined, the junction temperature can be derived from the Θ_{JA} for the MSOP-8 package.

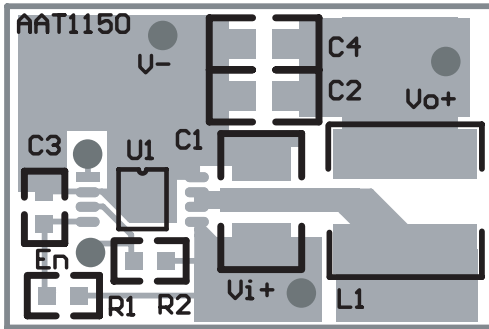

Figure 4: AAT1150 Layout Top Layer.

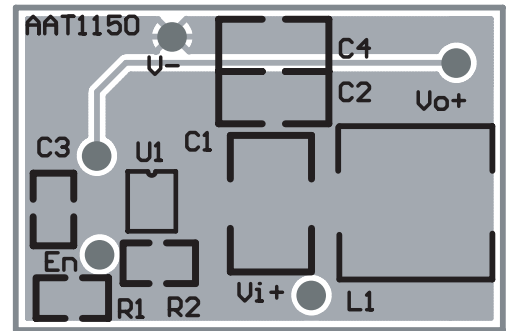
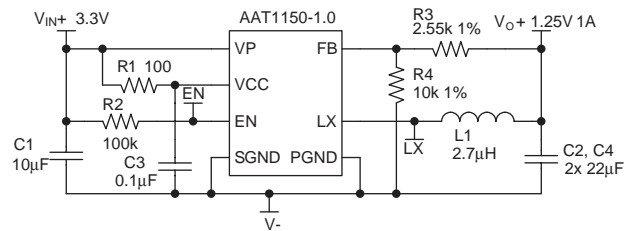

Figure 5: AAT1150 Layout Bottom Layer.



C1 Murata 10µF 6.3V X5R GRM42-6X 5R106K6.3
 C2, C4 MuRata 22µF 6.3V GRM21BR60J226ME39L X5R 0805
 L1 Sumida CDRH4D28-2R7µH

Figure 6: 3.3V to 1.25V Converter (Adjustable Output).

Design Example

Specifications

$$I_{OUT} = 1.0A$$

$$I_{RIPPLE} = 30\% \text{ of Full Load at Max } V_{IN}$$

$$V_{OUT} = 1.5V$$

$$V_{IN} = 2.7V \text{ to } 4.2V \text{ (3.6V nominal)}$$

$$F_s = 830kHz$$

Maximum Input Capacitor Ripple

$$I_{RMS} = I_O \cdot \sqrt{\frac{V_O}{V_{IN}} \cdot \left(1 - \frac{V_O}{V_{IN}}\right)} = \frac{I_O}{2} = 0.5A_{RMS}, V_{IN} = 2 \times V_O$$

$$P = ESR_{COUT} \cdot I_{RMS}^2 = 5m\Omega \cdot 0.5^2 A = 1.25mW$$

Inductor Selection

$$L = \frac{V_{OUT}}{I_O \cdot k \cdot F} \cdot \left(1 - \frac{V_{OUT}}{V_{IN}}\right) = \frac{1.5V}{1.0A \cdot 0.3 \cdot 830kHz} \cdot \left(1 - \frac{1.5V}{4.2V}\right) = 3.9\mu H$$

Select Sumida inductor CDRH5D18, 4.1 μ H, 57m Ω , 2.0mm height.

$$\Delta I = \frac{V_O}{L \cdot F} \cdot \left(1 - \frac{V_O}{V_{IN}}\right) = \frac{1.5V}{4.1\mu H \cdot 830kHz} \cdot \left(1 - \frac{1.5V}{4.2V}\right) = 280mA$$

$$I_{PK} = I_{OUT} + \frac{\Delta I}{2} = 1.0A + 0.14A = 1.14A$$

$$P = I_O^2 \cdot DCR = 57mW$$

Output Capacitor Dissipation

$$I_{RMS} = \frac{1}{2 \cdot \sqrt{3}} \cdot \frac{V_{OUT} \cdot (V_{IN} - V_{OUT})}{L \cdot F \cdot V_{IN}} = \frac{1}{2 \cdot \sqrt{3}} \cdot \frac{1.5V \cdot (4.2V - 1.5V)}{4.1\mu H \cdot 830kHz \cdot 4.2V} = 82mA_{RMS}$$

$$P_{ESR} = ESR_{COUT} \cdot I_{RMS}^2 = 5m\Omega \cdot 0.082^2 A = 33\mu W$$

AAT1150 Dissipation

$$P = \frac{I_o^2 \cdot (R_{\text{DSON(H)}} \cdot V_o + R_{\text{DSON(L)}} \cdot (V_{\text{IN}} - V_o))}{V_{\text{IN}}} + (t_{\text{sw}} \cdot F \cdot I_o + I_Q) \cdot V_{\text{IN}}$$

$$= \frac{(0.14\Omega \cdot 1.5V + 0.145\Omega \cdot (3.6V - 1.5V))}{3.6V} + (20\text{nsec} \cdot 830\text{kHz} \cdot 1.0A + 0.3\text{mA}) \cdot 3.6V = 0.203W$$

$$T_{\text{J(MAX)}} = T_{\text{AMB}} + \Theta_{\text{JA}} \cdot P_{\text{LOSS}} = 85^\circ\text{C} + 150^\circ\text{C/W} \cdot 0.203W = 115^\circ\text{C}$$

Table 1: Surface Mount Inductors.

Manufacturer	Part Number	Value	Max DC Current	DCR	Size (mm) L x W x H	Type
TaiyoYuden	NPO5DB4R7M	4.7μH	1.4A	0.038	5.9 x 6.1 x 2.8	Shielded
Toko	A914BYW-3R5M-D52LC	3.5μH	1.34A	0.073	5.0 x 5.0 x 2.0	Shielded
Sumida	CDRH5D28-4R2	4.2μH	2.2A	0.031	5.7 x 5.7 x 3.0	Shielded
Sumida	CDRH5D18-4R1	4.1μH	1.95A	0.057	5.7 x 5.7 x 2.0	Shielded
MuRata	LQH55DN4R7M03	4.7μH	2.7A	0.041	5.0 x 5.0 x 4.7	Non-Shielded
MuRata	LQH66SN4R7M03	4.7μH	2.2A	0.025	6.3 x 6.3 x 4.7	Shielded

Table 2: Surface Mount Capacitors.

Manufacturer	Part Number	Value	Voltage	Temp. Co.	Case
MuRata	GRM40 X5R 106K 6.3	10μF	6.3V	X5R	0805
MuRata	GRM42-6 X5R 106K 6.3	10μF	6.3V	X5R	1206
MuRata	GRM21BR60J226ME39L	22μF	6.3V	X5R	0805
MuRata	GRM21BR60J106ME39L	10μF	6.3V	X5R	0805

Ordering Information

Output Voltage	Package	Marking	Part Number (Tape and Reel)
1.0V (Adj $V_{OUT} \geq 1.0V$)	MSOP-8	JZXY	AAT1150IKS-1.0-T1
1.5V	MSOP-8	HYXY	AAT1150IKS-1.5-T1
1.8V	MSOP-8	KAXY	AAT1150IKS-1.8-T1
2.5V	MSOP-8	KCXY	AAT1150IKS-2.5-T1
3.3V	MSOP-8	HZXY	AAT1150IKS-3.3-T1

Package Information

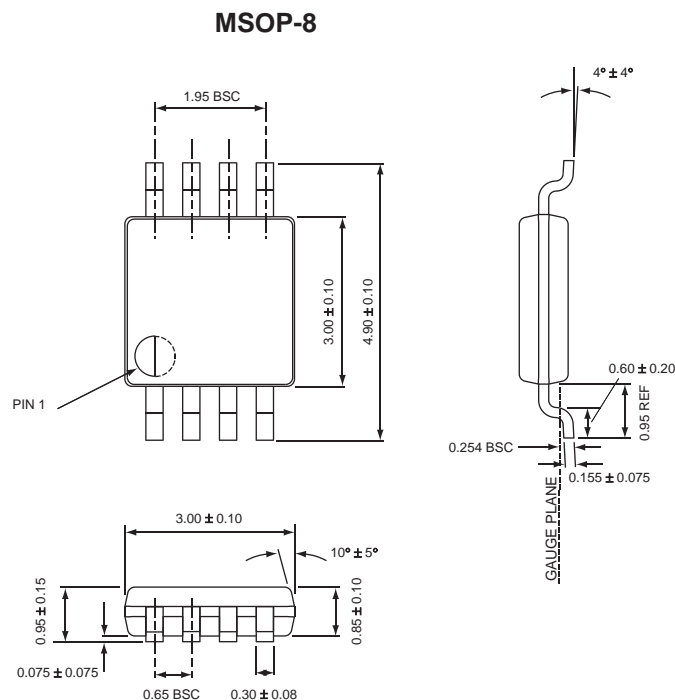

All dimensions in millimeters.

1. XYY = assembly and date code.
2. Sample stock is held on part numbers listed in **bold**. Contact local sales office for custom options.

AnalogicTech cannot assume responsibility for use of any circuitry other than circuitry entirely embodied in an AnalogicTech product. No circuit patent licenses, copyrights, mask work rights, or other intellectual property rights are implied.

AnalogicTech reserves the right to make changes to their products or specifications or to discontinue any product or service without notice, and advise customers to obtain the latest version of relevant information to verify, before placing orders, that information being relied on is current and complete. All products are sold subject to the terms and conditions of sale supplied at the time of order acknowledgement, including those pertaining to warranty, patent infringement, and limitation of liability.

AnalogicTech warrants performance of its semiconductor products to the specifications applicable at the time of sale in accordance with AnalogicTech's standard warranty. Testing and other quality control techniques are utilized to the extent AnalogicTech deems necessary to support this warranty. Specific testing of all parameters of each device is not necessarily performed.

Advanced Analogic Technologies, Inc.
 830 E. Arques Avenue, Sunnyvale, CA 94085
 Phone (408) 737-4600
 Fax (408) 737-4611