

GL1□□136 series

ø2mm, Forming Type, Colored Diffusion, Compact LED Lamp for Backlight/Indicator

Outline Dimensions

(Unit:mm)

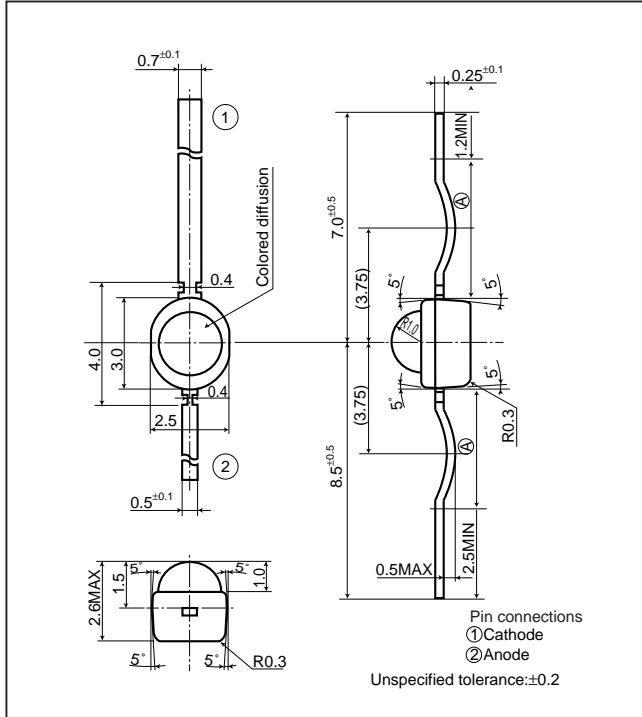

Radiation Diagram

(Ta=25°C)

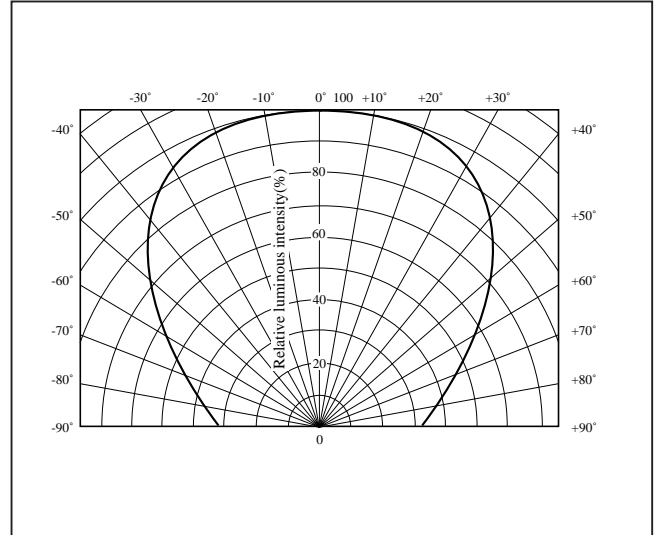

Absolute Maximum Ratings

(Ta=25°C)

Model No.	Radiation color	Radiation material	Power dissipation P (mW)	Forward current IF (mA)	Peak forward current IFM*1 (mA)	Derating factor (mA/°C)		Reverse voltage VR (V)	Operating temperature Topr (°C)	Storage temperature Tstg (°C)	Soldering temperature Tsol*2 (°C)
						DC	Pulse				
GL1PR136	Red	GaP	23	10	50	0.13	0.67	5	-25 to +85	-25 to +100	260
GL1HD136	Red	GaAsP on GaP	85	30	50	0.40	0.67	5	-25 to +85	-25 to +100	260
GL1HS136	Sunset orange	GaAsP on GaP	85	30	50	0.40	0.67	5	-25 to +85	-25 to +100	260
GL1HY136	Yellow	GaAsP on GaP	50	20	50	0.27	0.67	5	-25 to +85	-25 to +100	260
GL1EG136	Yellow-green	GaP	50	20	50	0.27	0.67	5	-25 to +85	-25 to +100	260

*1 Duty ratio=1/10, Pulse width=0.1ms

*2 Below the(A) portion of outline drawing

Electro-optical Characteristics

(Ta=25°C)

Lens type	Model No.	Forward voltage VF(V)		Peak emission wavelength λp(nm)		Luminous intensity Iv(mcd)		Spectrum radiation bandwidth Δλ(nm)		Reverse current IR(μA)		Terminal capacitance Ci(pF)		Page for characteristics diagrams
		TYP	MAX	TYP	IF (mA)	TYP	IF (mA)	TYP	IF (mA)	MAX	VR (V)	TYP	(MHz)	
Colored diffusion	GL1PR136	1.9	2.3	695	5	2.6	5	100	5	10	4	55	1	→
	GL1HD136	2.0	2.8	635	20	8.8	20	35	20	10	4	20	1	→
	GL1HS136	2.0	2.8	610	20	14.4	20	35	20	10	4	15	1	→
	GL1HY136	1.9	2.5	585	10	4.5	10	30	10	10	4	35	1	→
	GL1EG136	1.95	2.5	565	10	7.0	10	30	10	10	4	35	1	→

(Notice) • In the absence of confirmation by device specification sheets, SHARP takes no responsibility for any defects that may occur in equipment using any SHARP devices shown in catalogs, data books, etc. Contact SHARP in order to obtain the latest device specification sheets before using any SHARP device.
 (Internet) • Data for sharp's optoelectronic/power device is provided for internet.(Address <http://www.sharp.co.jp/ecg/>)

LED Lamp Characteristics Diagrams

PR series

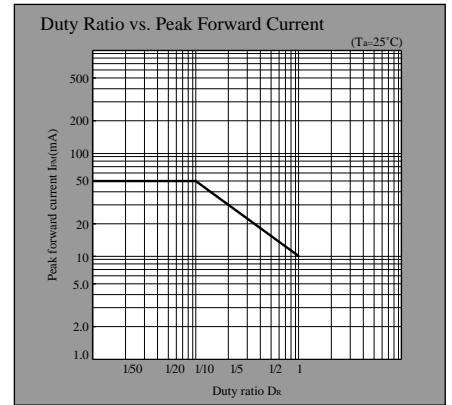
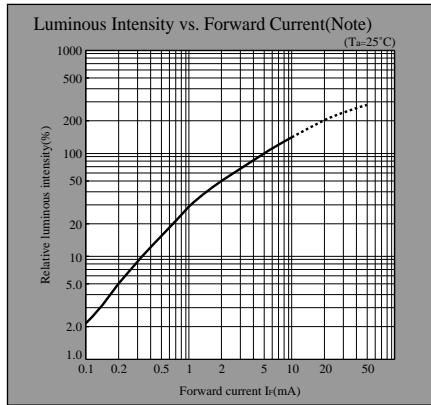
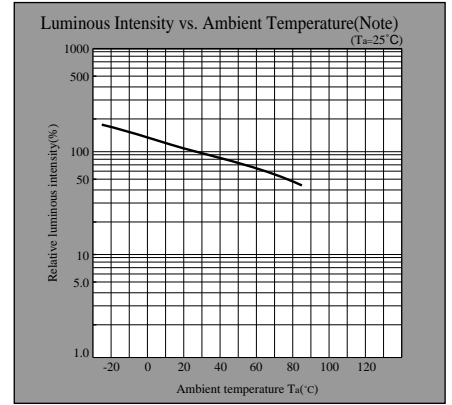
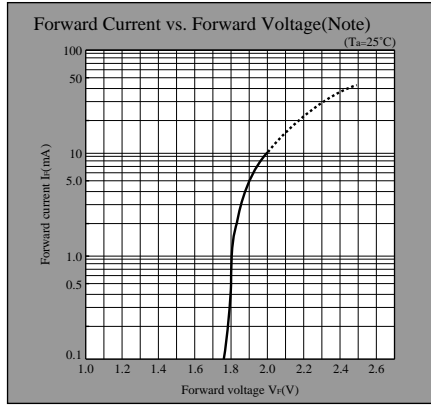

HD series

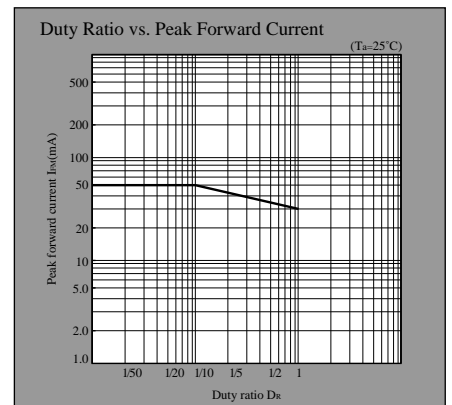
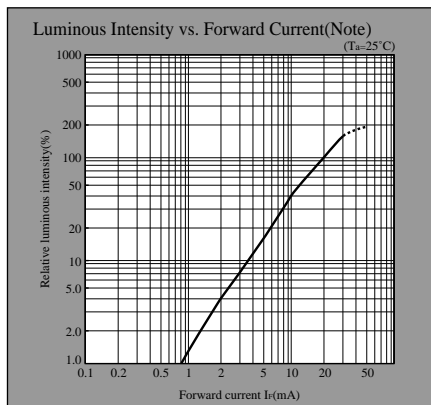
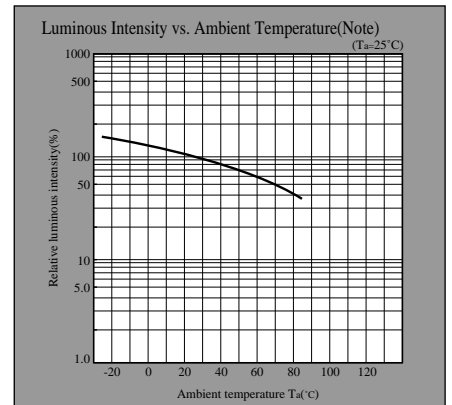
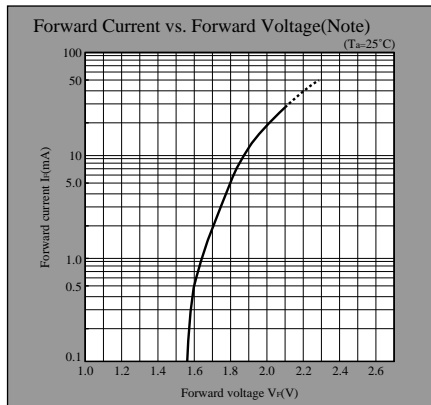

Note) Characteristics shown in diagrams are typical values. (not assurance value)

- (Notice) • In the absence of confirmation by device specification sheets, SHARP takes no responsibility for any defects that may occur in equipment using any SHARP devices shown in catalogs, data books, etc. Contact SHARP in order to obtain the latest device specification sheets before using any SHARP device.
 (Internet) • Data for sharp's optoelectronic/power device is provided for internet.(Address <http://www.sharp.co.jp/ecg/>)

LED Lamp Characteristics Diagrams

HS series

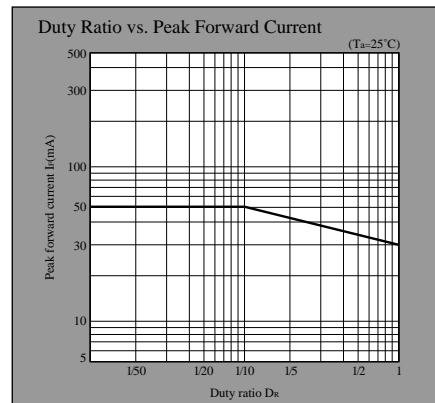
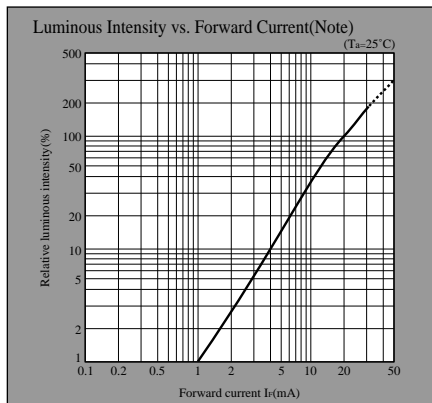
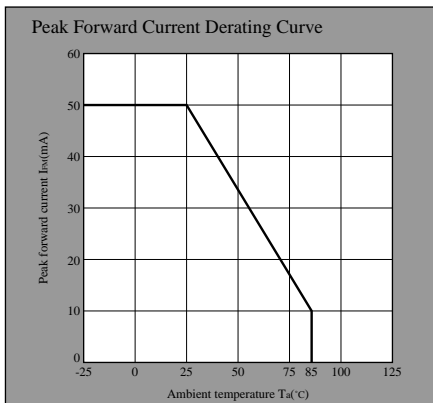
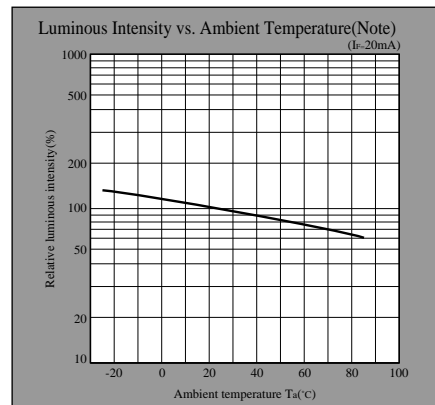
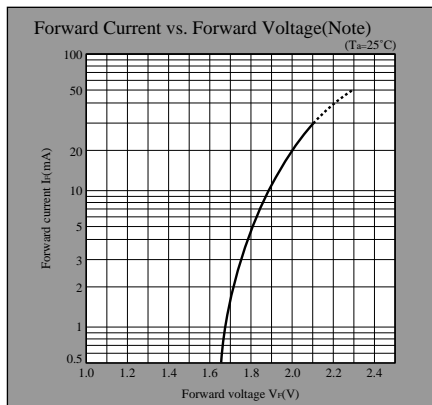
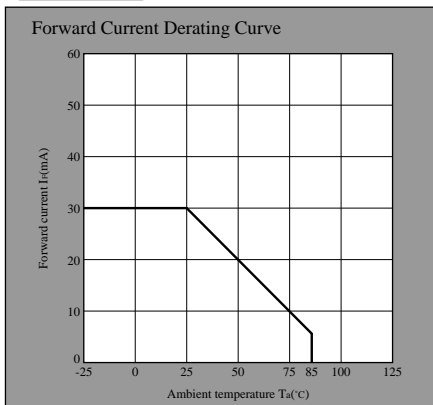

HY series

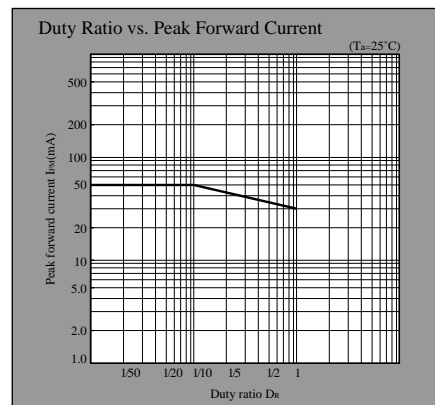
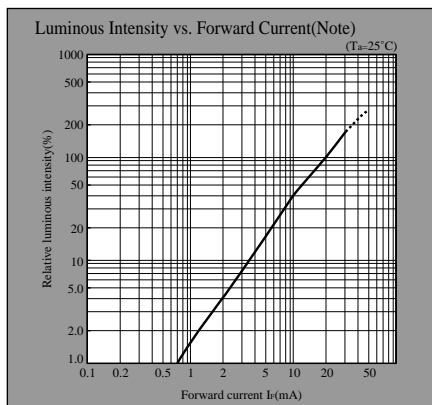
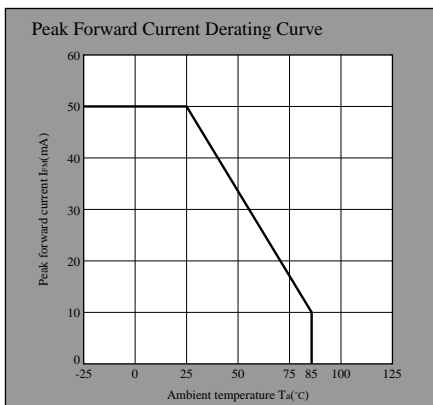
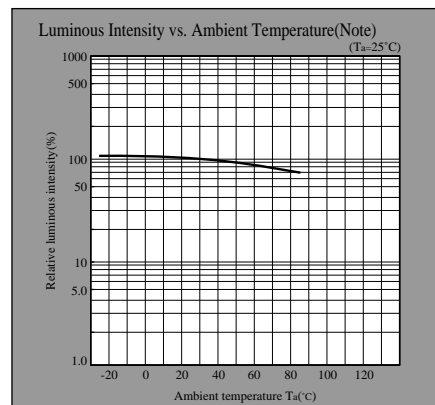
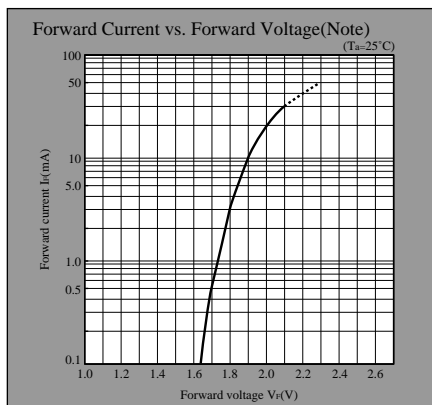
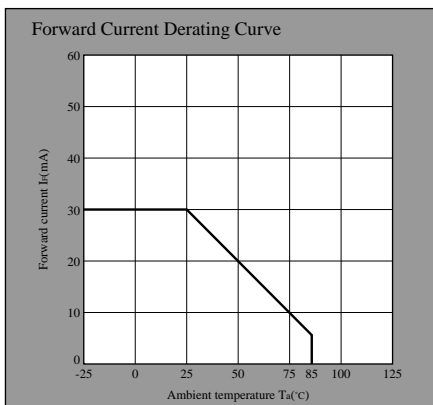

Note) Characteristics shown in diagrams are typical values. (not assurance value)

- (Notice) • In the absence of confirmation by device specification sheets, SHARP takes no responsibility for any defects that may occur in equipment using any SHARP devices shown in catalogs, data books, etc. Contact SHARP in order to obtain the latest device specification sheets before using any SHARP device.
- (Internet) • Data for sharp's optoelectronic/power device is provided for internet. (Address <http://www.sharp.co.jp/ecg/>)

Forward Current Derating Curve



Forward Current vs. Forward Voltage(Note)



Luminous Intensity vs. Ambient Temperature(Note)

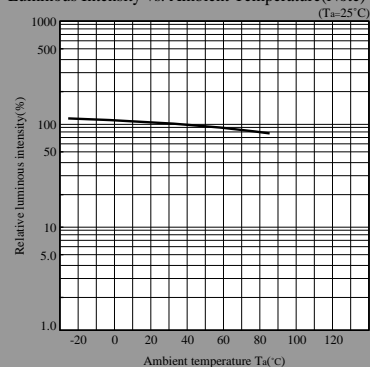

Peak Forward Current Derating Curve

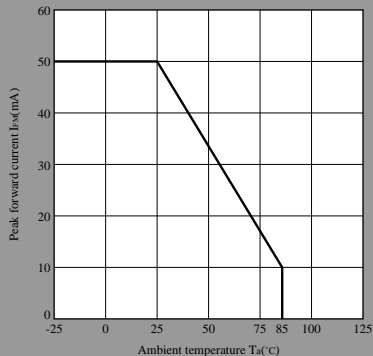

Luminous Intensity vs. Forward Current(Note)

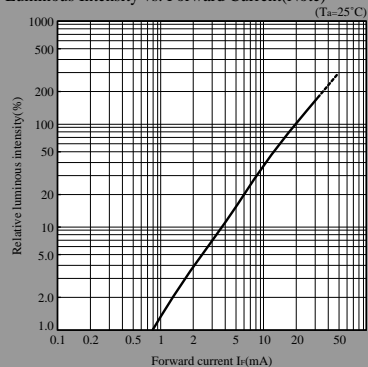

Duty Ratio vs. Peak Forward Current

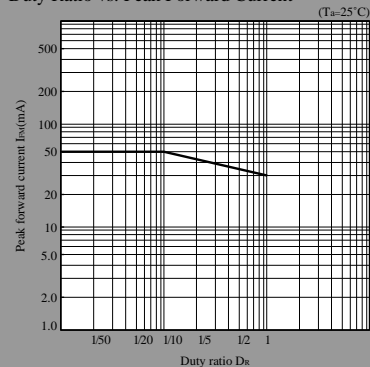

Note) Characteristics shown in diagrams are typical values. (not assurance value)