

# NAIS

**GU (General Use) Type DIP  
6-Pin Series 1-Channel  
(Form A) with Short Circuit  
Protection (Non Latch Type)**

# PhotoMOS RELAYS

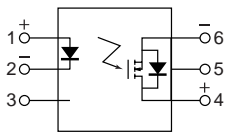
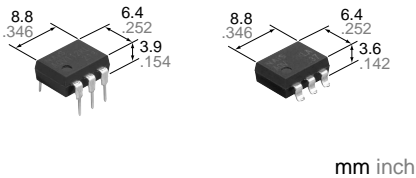

## FEATURES

### 1. Protects Circuit from excess current

The short circuit protection function prevents the continued flow of short current. After short current is detected, load current is monitored, and if the load returns to normal, the relay returns to normal operation.

### 2. No need for fuses, polyswitches, or other protectors

The built-in short circuit protection function eliminates the need for overcurrent protectors, reducing mounting costs and space requirements.

### 3. High capacity

Can control up to 0.5A (60 VDC) load current.

## TYPICAL APPLICATIONS

- Industrial equipment
- Traffic signal control
- Security equipment

## TYPES

Type	I/O isolation voltage	Output rating*		Part No.				Packing quantity	
				Through hole terminal	Surface-mount terminal		Tube	Tape and reel	
									Tube packing style
Load voltage	Load current		Picked from the 1/2/3-pin side	Picked from the 4/5/6-pin side					
DC type	1,500 V	60 V	500 mA	AQV112KL	AQV112KLA	AQV112KLAX	AQV112KLAZ	1 tube contains 50 pcs. 1 batch contains 500 pcs.	1,000 pcs.

\*Indicate the DC values.

Note: For space reasons, the package type indicator "X" and "Z" are omitted from the seal.

## RATING

1. Absolute maximum ratings (Ambient temperature: 25°C 77°F)

Item	Symbol	AQV112KL
Input	LED forward current	I <sub>F</sub> 50 mA
	LED reverse voltage	V <sub>R</sub> 5 V
	Peak forward current	I <sub>FP</sub> 1 A
	Power dissipation	P <sub>in</sub> 75 mW
Output	Load voltage (peak AC)	V <sub>L</sub> 7 to 60V
	Continuous load current (peak AC)	I <sub>L</sub> 0.5 A
	Power dissipation	P <sub>out</sub> 500 mW
Total power dissipation	P <sub>T</sub>	550 mW
I/O isolation voltage	V <sub>iso</sub>	1,500 V AC
Temperature limits	Operating	T <sub>opr</sub> -40°C to +85°C -40°F to +185°F
	Storage	T <sub>stg</sub> -40°C to +100°C -40°F to +212°F

## 2. Electrical characteristics (Ambient temperature: 25°C 77°F)

Item		Symbol	AQV112KL	Condition
Input	LED operate current	Typical	0.8 mA	$I_L = 100\text{mA}$
		Maximum	10 mA	
	LED turn off current	Minimum	0.3 mA	$I_L = 100\text{mA}$
		Typical	0.7 mA	
LED dropout voltage	Typical	1.17 V	$I_F = 10\text{ mA}$	
	Maximum	1.5 V		
Output	On resistance	Typical	0.55 $\Omega$	$I_F = 10\text{ mA}$ $I_L = \text{Max.}$
		Maximum	2.0 $\Omega$	
	Load short circuit detection voltage	Typical	5 V	$I_F = 10\text{ mA}$
		Maximum	7 V	
	Off state leakage current	Maximum	1 $\mu\text{A}$	$I_F = 0\text{ mA}$ $V_L = \text{Max.}$
Transfer characteristics	Turn on time*	Typical	2.0 ms	$I_F = 10\text{ mA}$ $I_L = 100\text{ mA}$ $V_L = 10\text{ V}$
		Maximum	5.0 ms	
	Turn off time*	Typical	0.1 ms	$I_F = 10\text{ mA}$ $I_L = 100\text{ mA}$ $V_L = 10\text{ V}$
		Maximum	1.0 ms	
	I/O capacitance	Typical	0.8 pF	$f = 1\text{ MHz}$ $V_B = 0$
		Maximum	1.5 pF	
Initial I/O isolation resistance	Minimum	1,000 M $\Omega$	500 V DC	

Note: Recommendable LED forward current  $I_F = 10\text{ mA}$ .

For type of connection, see Page 11.

\*Turn on/Turn off time

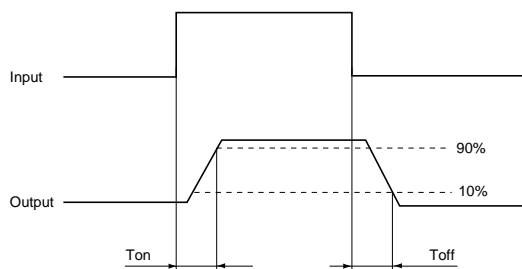

## REFERENCE DATA

### 1. Load current vs. ambient temperature characteristics

Allowable ambient temperature:  $-40^\circ\text{C}$  to  $+85^\circ\text{C}$   
 $-40^\circ\text{F}$  to  $+185^\circ\text{F}$

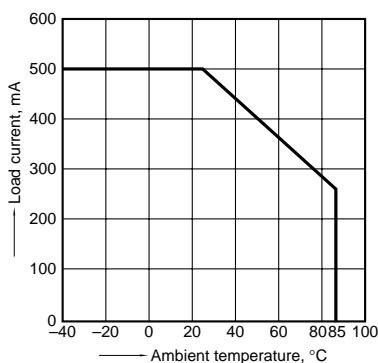

### 2. On resistance vs. ambient temperature characteristics

Measured portion: between terminals 4 and 6;  
LED current: 10 mA; Load current: Max.(DC)

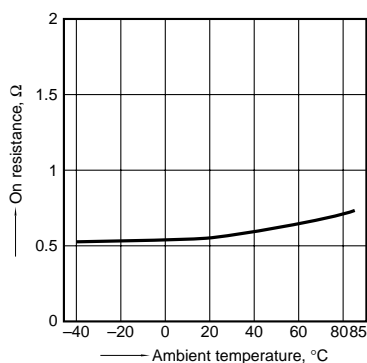

### 3. Turn on time vs. ambient temperature characteristics

Measured portion: between terminals 4 and 6;  
LED current: 10 mA; Load voltage: 10V (DC);  
Load current: 100 mA

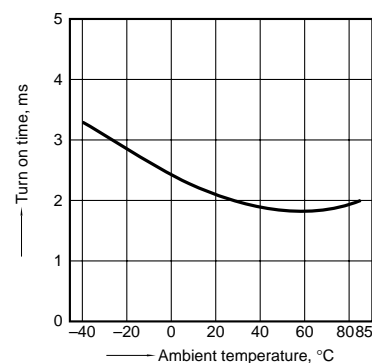

# AQV112KL

## 4. Turn off time vs. ambient temperature characteristics

Measured portion: between terminals 4 and 6;  
LED current: 10 mA; Load voltage: 10 V (DC);  
Load current: 100 mA (DC)

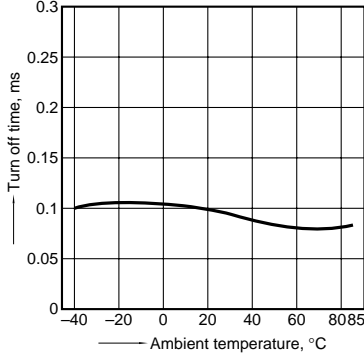

## 5. LED operate current vs. ambient temperature characteristics

Measured portion: between terminals 4 and 6;  
Load current: 100 mA

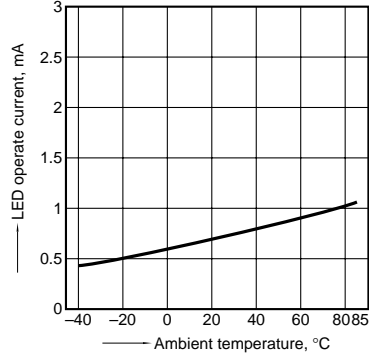

## 6. LED turn off current vs. ambient temperature characteristics

Measured portion: between terminals 4 and 6;  
Load current: 100 mA

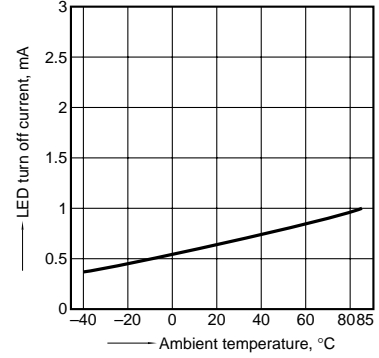

## 7. Off state leakage current

Measured portion: between terminals 4 and 6;  
Ambient temperature: 25°C 77°F

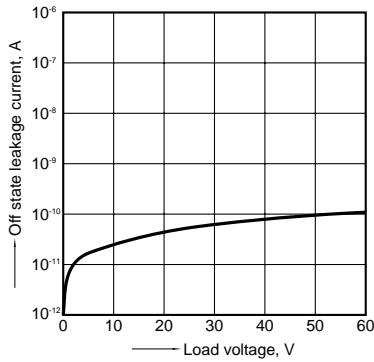

## 8. Voltage vs. current characteristics of output at MOS portion

Measured portion: between terminals 4 and 6;  
Ambient temperature: 25°C 77°F

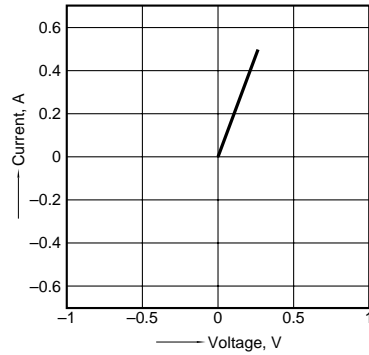

## 9. LED dropout voltage vs. ambient temperature characteristics

Measured portion: between terminals 1 and 2;  
LED current: 10 to 50 mA

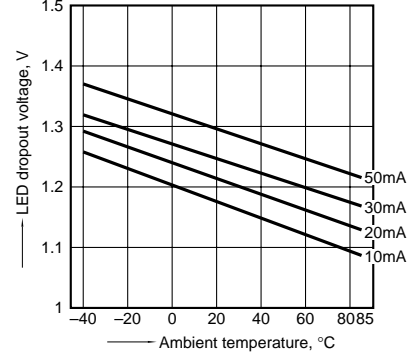

## 10. LED forward current vs. turn on time characteristics

Measured portion: between terminals 4 and 6;  
Load voltage: 10 V (DC); Load current: 100 mA (DC);  
Ambient temperature: 25°C 77°F

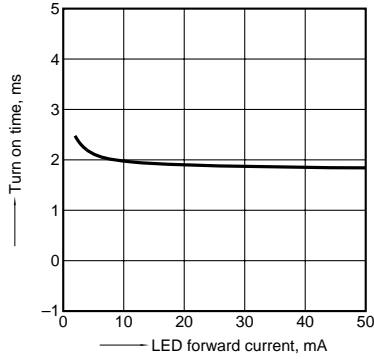

## 11. LED forward current vs. turn off time characteristics

Measured portion: between terminals 4 and 6;  
Load voltage: 10 V (DC); Load current: 100 mA (DC);  
Ambient temperature: 25°C 77°F

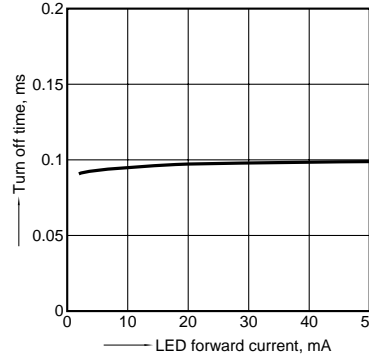

## 12. Applied voltage vs. output capacitance characteristics

Measured portion: between terminals 4 and 6;  
Frequency: 1 MHz; Ambient temperature: 25°C 77°F

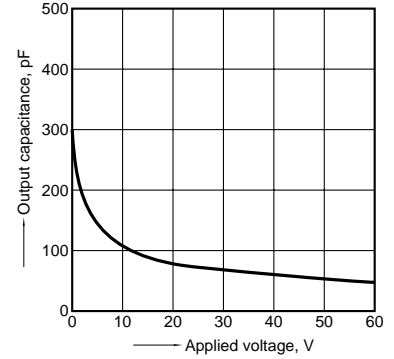

## 13. Short circuit peak current vs. time characteristics

Measured portion: between terminals 4 and 6;  
LED current: 10 mA; Load resistance: 0;  
Ambient temperature: 25°C 77°F

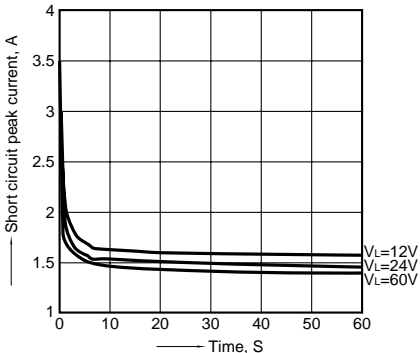

## 14. Short current monitoring interval vs. time characteristics

Measured portion: between terminals 4 and 6;  
LED current: 10 mA; Load resistance: 0;  
Ambient temperature: 25°C 77°F

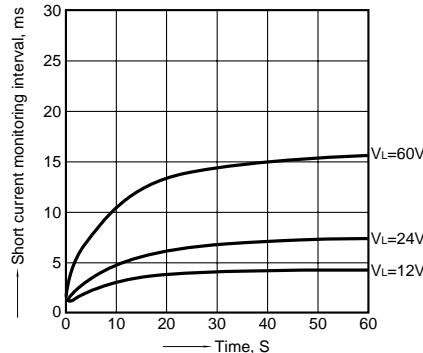

## What is short circuit protection Non-latch type?

If the load current reaches a predetermined overcurrent level, the output-side short circuit protection function cuts off the load current. It then monitors the load current, and if it returns to normal, automatically recovers to normal relay operation.

In order to operate the short circuit protection function, ensure that the input current is at least  $I_F = 10 \text{ mA}$ .

Operation chart (Non-latch type)

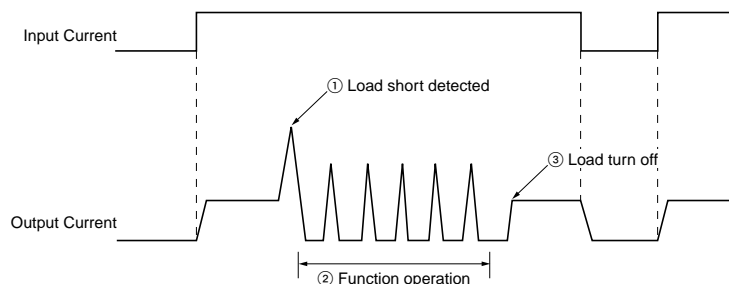

## DIMENSIONS

mm inch

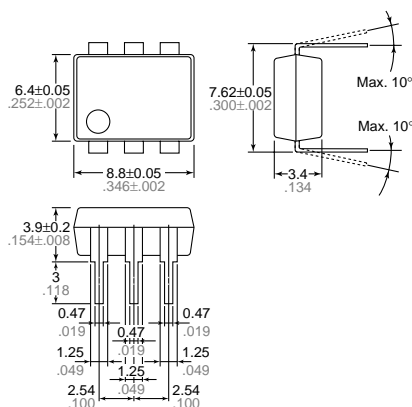

PC board pattern (BOTTOM VIEW)

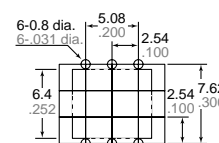

Terminal thickness = 0.25 .010

General tolerance:  $\pm 0.1 \pm .004$

Tolerance:  $\pm 0.1 \pm .004$

## SCHEMATIC AND WIRING DIAGRAMS

$E_1$ : Power source at input side;  $I_F$ : LED forward current;  $V_L$ : Load voltage;  $I_L$ : Load current

Schematic	Output configuration	Load	Wiring diagram
	1a	DC	<p>*Can be also connected as 2 Form A type. (However, the sum of the continuous load current should not exceed the absolute maximum rating.)</p>

**CAUTIONS FOR USE**

**1. Surge voltages at the input**

If reverse surge voltages are present at the input terminals, connect a diode in reverse parallel across the input terminals and keep the reverse voltages below the reverse breakdown voltage.

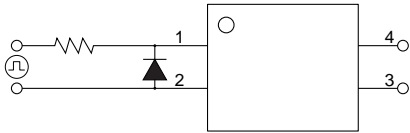

**2. Unused terminals**

The No. 3 and 5 terminal is used with the circuit inside the relay. Therefore, do not connect it to the external circuitry with either connection method A, B or C. (Non-latch type)

**3. It is possible that in-rush current will be detected as short current, and oscillation will be initiated. Please confirm before use.**

**4. Please avoid exposing the unit to short status for longer than 24 hours. Long periods of exposure to short status could damage the internal IC (non-latch type only).**

**5. Short across terminals**

Do not short circuit between terminals when relay is energized. There is possibility of breaking the internal IC.

**6. Output spike voltages**

1) If an inductive load generates spike voltages which exceed the absolute maximum rating, the spike voltage must be limited. Typical circuits are shown below.

Latch type

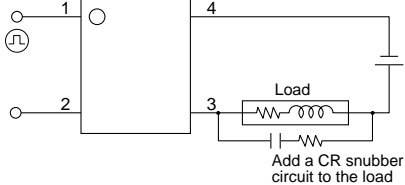
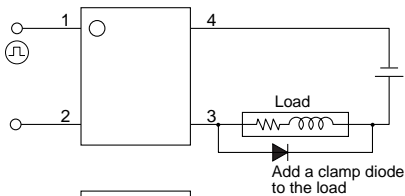

Non-latch type

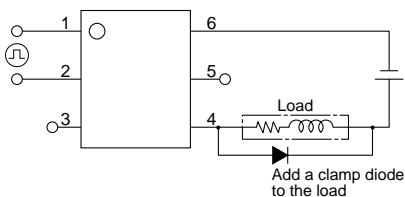

2) If spike voltages generated at the load are limited with a clamp diode and the circuit wires are long, spike voltages will occur by inductance. Keep wires as short as possible to minimize inductance.

**7. Ripple in the input power supply**

If ripple is present in the input power supply, observe the following:  
2) Keep the LED operate current at  $E_{min}$ , maintain min. 5 mA (Latch type), 10 mA (Non-latch type).

1) For LED operate current 50 mA or less at  $E_{max}$ .

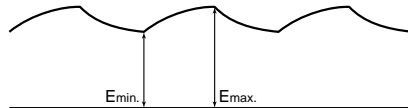

**8. When soldering terminals, keep soldering time to within 10 s at 260°C 500°F.**

**9. Cleaning solvents compatibility**

The PhotoMOS relay forms an optical path by coupling a light-emitting diode (LED) and photodiode via transparent silicon resin. For this reason, unlike other directory element molded resin products (e.g., MOS transistors and bipolar transistors), avoid ultrasonic cleansing if at all possible. We recommend cleaning with an organic solvent. If you cannot avoid using ultrasonic cleansing, please ensure that the following conditions are met, and check beforehand for defects.

- Frequency: 27 to 29 kHz
- Ultrasonic output: No greater than 0.25W/cm<sup>2</sup>
- Cleaning time: No longer than 30 s
- Cleanser used: Asahiklin AK-225
- Other: Submerge in solvent in order to prevent the PCB and elements from being contacted directly by the ultrasonic vibrations.

Note: Applies to unit area ultrasonic output for ultrasonic baths.

**10. Transportation and storage**

1) Extreme vibration during transport will warp the lead or damage the relay. Handle the outer and inner boxes with care.

2) Storage under extreme conditions will cause soldering degradation, external appearance defects, and deterioration of the characteristics. The following storage conditions are recommended:

- Temperature: 0 to 45°C 32 to 113°F
- Humidity: Less than 70% R.H.
- Atmosphere: No harmful gasses such as sulfurous acid gas, minimal dust.

**11. Soldering**

1) When soldering PC board terminals, keep soldering time to within 10 s at 260°C 500°F .

2) When soldering surface-mount terminals, the following conditions are recommended.

(1) IR (Infrared reflow) soldering method

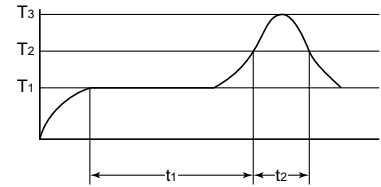

$T_1 = 155 \text{ to } 165^\circ\text{C } 311 \text{ to } 329^\circ\text{F}$   
 $T_2 = 180^\circ\text{C } 200^\circ\text{C } 356 \text{ to } 392^\circ\text{F}$   
 $T_3 = 245^\circ\text{C } 473^\circ\text{F or less}$   
 $t_1 = 120 \text{ s or less}$   
 $t_2 = 30 \text{ s or less}$

(2) Vapor phase soldering method

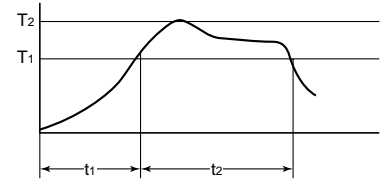

$T_1 = 180 \text{ to } 200^\circ\text{C } 366 \text{ to } 392^\circ\text{F}$   
 $T_2 = 215^\circ\text{C } 419^\circ\text{F or less}$   
 $t_1 = 40 \text{ s}$   
 $t_2 = 90 \text{ s or less}$

(3) Double wave soldering method

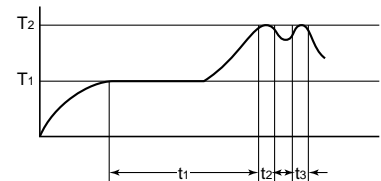

$T_1 = 155 \text{ to } 165^\circ\text{C } 311 \text{ to } 329^\circ\text{F}$   
 $T_2 = 260^\circ\text{C } 500^\circ\text{F or less}$   
 $t_1 = 60 \text{ s or less}$   
 $t_2+t_3 = 5 \text{ s or less}$

(4) Soldering iron method

Tip temperature: 280 to 300°C 536 to 572°F

Wattage: 30 to 60 W

Soldering time: within 5 s

(5) Others

Check mounting conditions before using other soldering methods (hot-air, hot plate, pulse heater, etc.)

• The temperature profile indicates the temperature of the soldered terminal on the surface of the PC board. The ambient temperature may increase excessively. Check the temperature under mounting conditions.

• The conditions for the infrared reflow soldering apply when preheating using the VPS method.

12. The following shows the packaging format

1) Tape and reel (AQY210KS)

mm inch

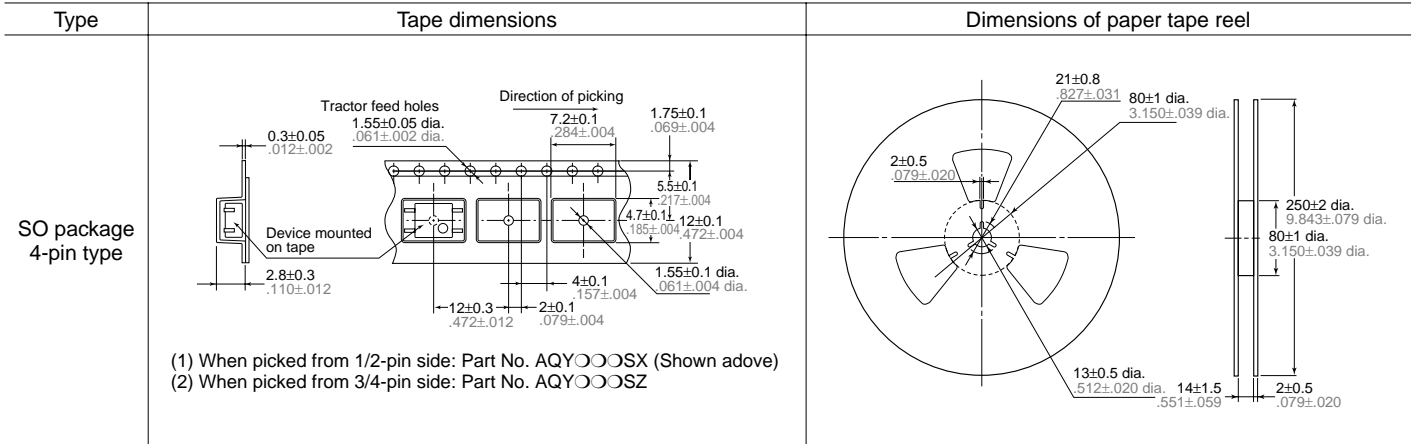

2) Tube

(1) Devices are packaged in a tube so pin No. 1 is on the stopper B side. Observe correct orientation when mounting them on PC boards.

(SOP type)

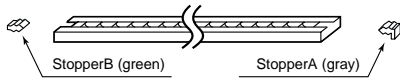

2) Storage

PhotoMOS relays implemented in SO packages are sensitive to moisture and come in sealed moisture-proof packages. Observe the following cautions on storage.

- After the moisture-proof package is unsealed, take the devices out of storage as soon as possible (within 1 month at the most).

- If the devices are to be left in storage for a considerable period after the moisture-proof package has been unsealed, it is recommended to keep them in another moisture-proof bag containing silica gel (within 3 months at the most).

13. Transportation and storage

1) Extreme vibration during transport will warp the lead or damage the relay. Handle the outer and inner boxes with care.

2) Storage under extreme conditions will cause soldering degradation, external appearance defects, and deterioration of the characteristics. The following storage conditions are recommended:

- Temperature: 0 to 45°C 32 to 113°F
- Humidity: Less than 70% R.H.
- Atmosphere: No harmful gasses such as sulfurous acid gas, minimal dust.

13. Applying stress that exceeds the absolute maximum rating

If the voltage or current value for any of the terminals exceeds the absolute maximum rating, internal elements will deteriorate because of the excessive voltage or current. In extreme cases, wiring may melt, or silicon P/N junctions may be destroyed.

As a result, the design should ensure that the absolute maximum ratings will never be exceeded, even momentarily.

1) Tape and reel (AQV112KL)

mm inch

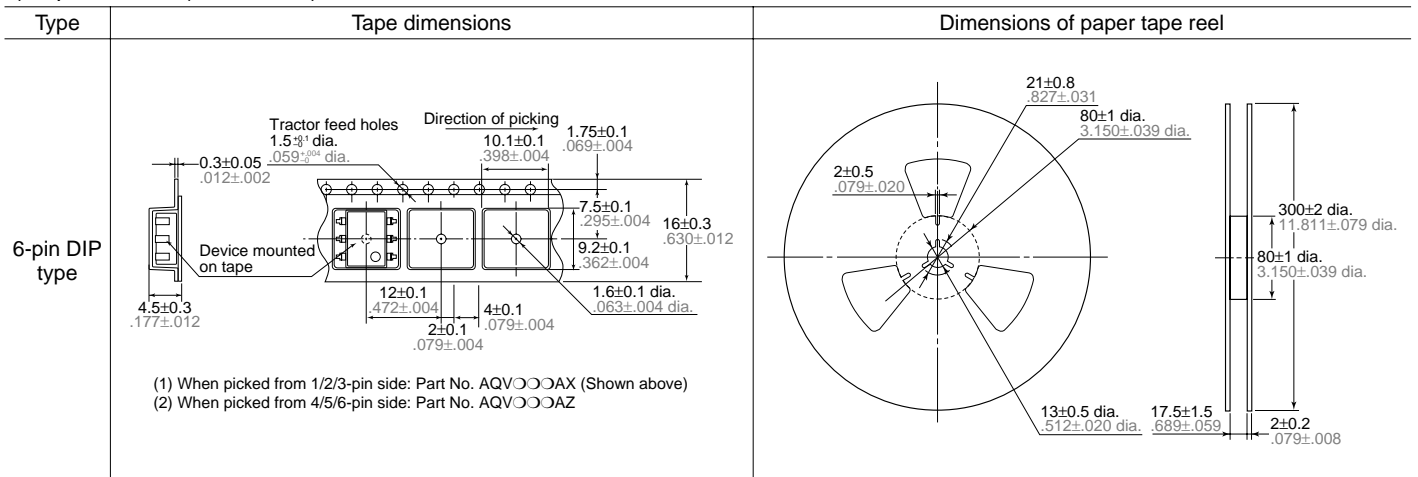

2) Tube

(1) Devices are packaged in a tube so pin No. 1 is on the stopper B side. Observe correct orientation when mounting them on PC boards.

(DIP type)

(DIP, SMD type)

