

FCP11N60/FCPF11N60

General Description

SuperFET™ is a new generation of high voltage MOSFETs from Fairchild with outstanding low on-resistance and low gate charge performance, a result of proprietary technology utilizing advanced charge balance mechanisms.

This advanced technology has been tailored to minimize conduction loss, provide superior switching performance, and withstand extreme dv/dt rate and higher avalanche energy. Consequently, SuperFET is very suitable for various AC/DC power conversion in switching mode operation for system miniaturization and higher efficiency.

Features

- 650V @ $T_j = 150^\circ\text{C}$
- Typ. $R_{ds(on)} = 0.32\Omega$
- Ultra low gate charge (typ. $Q_g = 40\text{nC}$)
- Low effective output capacitance (typ. $C_{oss,eff} = 95\text{pF}$)
- 100% avalanche tested

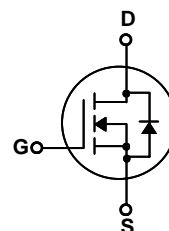
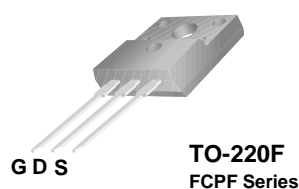
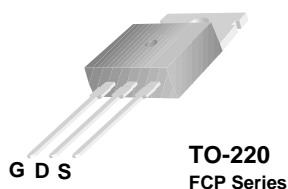

Absolute Maximum Ratings $T_C = 25^\circ\text{C}$ unless otherwise noted

| Symbol | Parameter | FCP11N60 | FCPF11N60 | Units |
|----------------|---|-------------|-----------|---------------------|
| I_D | Drain Current - Continuous ($T_C = 25^\circ\text{C}$) | 11 | 11* | A |
| | | 7 | 7* | A |
| | - Continuous ($T_C = 100^\circ\text{C}$) | | | A |
| I_{DM} | Drain Current - Pulsed (Note 1) | 33 | 33* | A |
| V_{GSS} | Gate-Source Voltage | ± 30 | | V |
| E_{AS} | Single Pulsed Avalanche Energy (Note 2) | 340 | | mJ |
| I_{AR} | Avalanche Current (Note 1) | 11 | | A |
| E_{AR} | Repetitive Avalanche Energy (Note 1) | 12.5 | | mJ |
| dv/dt | Peak Diode Recovery dv/dt (Note 3) | 4.5 | | V/ns |
| P_D | Power Dissipation ($T_C = 25^\circ\text{C}$) | 125 | 36 | W |
| | | 1.0 | 0.29 | W/ $^\circ\text{C}$ |
| | - Derate above 25°C | | | |
| T_J, T_{STG} | Operating and Storage Temperature Range | -55 to +150 | | $^\circ\text{C}$ |
| T_L | Maximum lead temperature for soldering purposes, 1/8" from case for 5 seconds | 300 | | $^\circ\text{C}$ |

* Drain current limited by maximum junction temperature

Thermal Characteristics

| Symbol | Parameter | FCP11N60 | FCPF11N60 | Units |
|-----------------|---|----------|-----------|---------------------------|
| $R_{\theta JC}$ | Thermal Resistance, Junction-to-Case | 1.0 | 3.5 | $^\circ\text{C}/\text{W}$ |
| $R_{\theta CS}$ | Thermal Resistance, Case-to-Sink | 0.5 | -- | $^\circ\text{C}/\text{W}$ |
| $R_{\theta JA}$ | Thermal Resistance, Junction-to-Ambient | 62.5 | 62.5 | $^\circ\text{C}/\text{W}$ |

Electrical Characteristics

$T_C = 25^\circ\text{C}$ unless otherwise noted

| Symbol | Parameter | Test Conditions | Min | Typ | Max | Units |
|--------------------------------|---|--|-----|-----|------|---------------------|
| Off Characteristics | | | | | | |
| BV_{DSS} | Drain-Source Breakdown Voltage | $V_{GS} = 0\text{ V}, I_D = 250\ \mu\text{A}, T_J = 25^\circ\text{C}$ | 600 | -- | -- | V |
| | | $V_{GS} = 0\text{ V}, I_D = 250\ \mu\text{A}, T_J = 150^\circ\text{C}$ | -- | 650 | -- | V |
| $\Delta BV_{DSS} / \Delta T_J$ | Breakdown Voltage Temperature Coefficient | $I_D = 250\ \mu\text{A}$, Referenced to 25°C | -- | 0.6 | -- | V/ $^\circ\text{C}$ |
| BV_{DS} | Drain-Source Avalanche Breakdown Voltage | $V_{GS} = 0\text{ V}, I_D = 11\text{ A}$ | -- | 700 | -- | V |
| I_{DSS} | Zero Gate Voltage Drain Current | $V_{DS} = 600\text{ V}, V_{GS} = 0\text{ V}$ | -- | -- | 1 | μA |
| | | $V_{DS} = 480\text{ V}, T_C = 125^\circ\text{C}$ | -- | -- | 10 | μA |
| I_{GSSF} | Gate-Body Leakage Current, Forward | $V_{GS} = 30\text{ V}, V_{DS} = 0\text{ V}$ | -- | -- | 100 | nA |
| I_{GSSR} | Gate-Body Leakage Current, Reverse | $V_{GS} = -30\text{ V}, V_{DS} = 0\text{ V}$ | -- | -- | -100 | nA |

On Characteristics

| | | | | | | |
|--------------|-----------------------------------|---|-----|------|------|----------|
| $V_{GS(th)}$ | Gate Threshold Voltage | $V_{DS} = V_{GS}, I_D = 250\ \mu\text{A}$ | 3.0 | -- | 5.0 | V |
| $R_{DS(on)}$ | Static Drain-Source On-Resistance | $V_{GS} = 10\text{ V}, I_D = 5.5\text{ A}$ | -- | 0.32 | 0.38 | Ω |
| g_{FS} | Forward Transconductance | $V_{DS} = 40\text{ V}, I_D = 5.5\text{ A}$ (Note 4) | -- | 9.7 | -- | S |

Dynamic Characteristics

| | | | | | | |
|-----------------|------------------------------|--|----|------|------|----|
| C_{iss} | Input Capacitance | $V_{DS} = 25\text{ V}, V_{GS} = 0\text{ V}, f = 1.0\text{ MHz}$ | -- | 1148 | 1490 | pF |
| C_{oss} | Output Capacitance | | -- | 671 | 870 | pF |
| C_{riss} | Reverse Transfer Capacitance | | -- | 63 | 82 | pF |
| C_{oss} | Output Capacitance | $V_{DS} = 480\text{ V}, V_{GS} = 0\text{ V}, f = 1.0\text{ MHz}$ | -- | 35 | -- | pF |
| $C_{oss\ eff.}$ | Effective Output Capacitance | $V_{DS} = 0\text{ V to } 480\text{ V}, V_{GS} = 0\text{ V}$ | -- | 95 | -- | pF |

Switching Characteristics

| | | | | | | | |
|--------------|---------------------|--|-------------|-----|-----|-----|----|
| $t_{d(on)}$ | Turn-On Delay Time | $V_{DD} = 300\text{ V}, I_D = 11\text{ A}, R_G = 25\ \Omega$ | -- | 34 | 80 | ns | |
| t_r | Turn-On Rise Time | | -- | 98 | 205 | ns | |
| $t_{d(off)}$ | Turn-Off Delay Time | | (Note 4, 5) | -- | 119 | 250 | ns |
| t_f | Turn-Off Fall Time | | -- | 56 | 120 | ns | |
| Q_g | Total Gate Charge | $V_{DS} = 480\text{ V}, I_D = 11\text{ A}, V_{GS} = 10\text{ V}$ | -- | 40 | 52 | nC | |
| Q_{gs} | Gate-Source Charge | | -- | 7.2 | -- | nC | |
| Q_{gd} | Gate-Drain Charge | | (Note 4, 5) | -- | 21 | -- | nC |

Drain-Source Diode Characteristics and Maximum Ratings

| | | | | | | |
|----------|---|--|----|-----|-----|---------------|
| I_S | Maximum Continuous Drain-Source Diode Forward Current | -- | -- | 11 | A | |
| I_{SM} | Maximum Pulsed Drain-Source Diode Forward Current | -- | -- | 33 | A | |
| V_{SD} | Drain-Source Diode Forward Voltage | $V_{GS} = 0\text{ V}, I_S = 11\text{ A}$ | -- | -- | 1.4 | V |
| t_{rr} | Reverse Recovery Time | $V_{GS} = 0\text{ V}, I_S = 11\text{ A}, dI_F / dt = 100\text{ A}/\mu\text{s}$ | -- | 390 | -- | ns |
| Q_{rr} | Reverse Recovery Charge | (Note 4) | -- | 5.7 | -- | μC |

Notes:

1. Repetitive Rating : Pulse width limited by maximum junction temperature
2. $I_{AS} = 5.5\text{ A}, V_{DD} = 50\text{ V}, R_G = 25\ \Omega$, Starting $T_J = 25^\circ\text{C}$
3. $I_{SD} \leq 11\text{ A}, di/dt \leq 200\text{ A}/\mu\text{s}, V_{DD} \leq BV_{DSS}$, Starting $T_J = 25^\circ\text{C}$
4. Pulse Test : Pulse width $\leq 300\ \mu\text{s}$, Duty cycle $\leq 2\%$
5. Essentially independent of operating temperature

Typical Characteristics

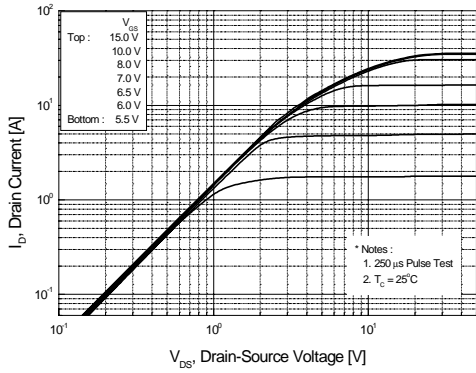

Figure 1. On-Region Characteristics

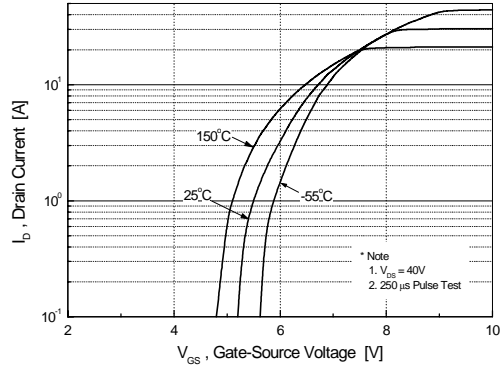

Figure 2. Transfer Characteristics

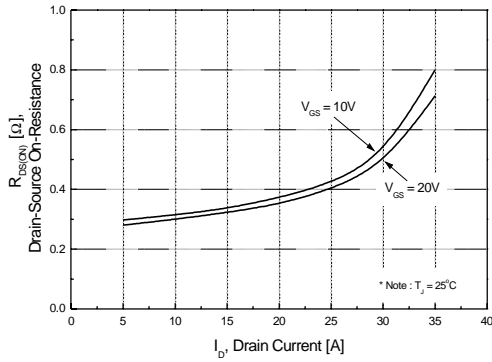

Figure 3. On-Resistance Variation vs. Drain Current and Gate Voltage

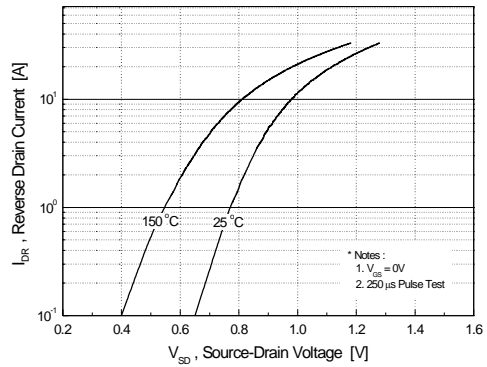

Figure 4. Body Diode Forward Voltage Variation vs. Source Current and Temperature

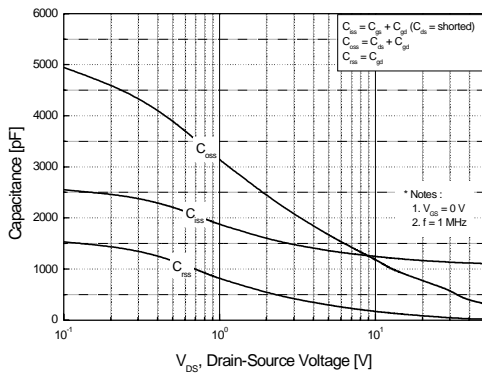

Figure 5. Capacitance Characteristics

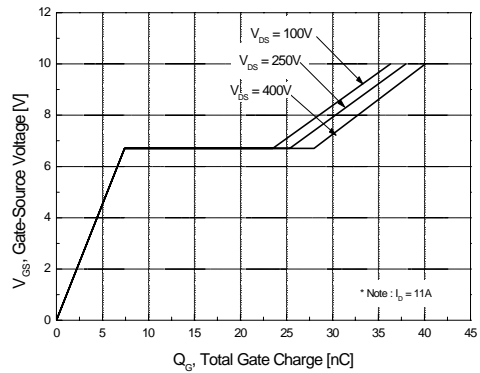

Figure 6. Gate Charge Characteristics

Typical Characteristics (Continued)

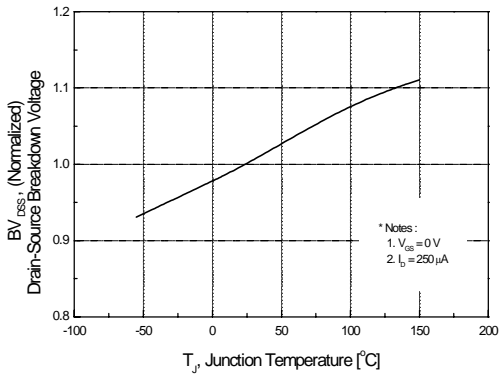

Figure 7. Breakdown Voltage Variation vs. Temperature

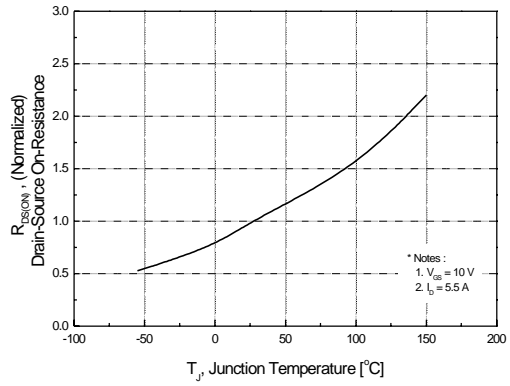

Figure 8. On-Resistance Variation vs. Temperature

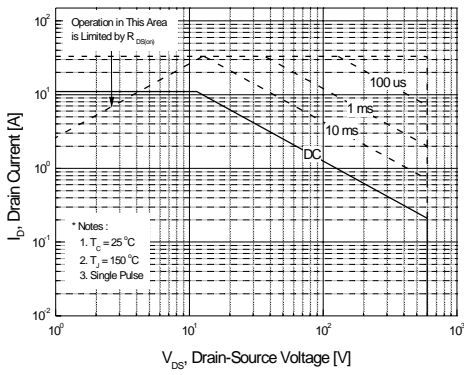

Figure 9-1. Maximum Safe Operating Area for FCP11N60

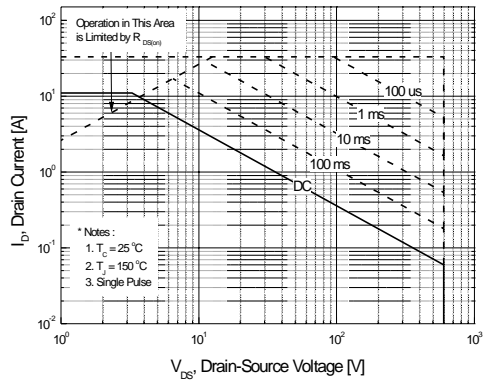

Figure 9-2. Maximum Safe Operating Area for FCPF11N60

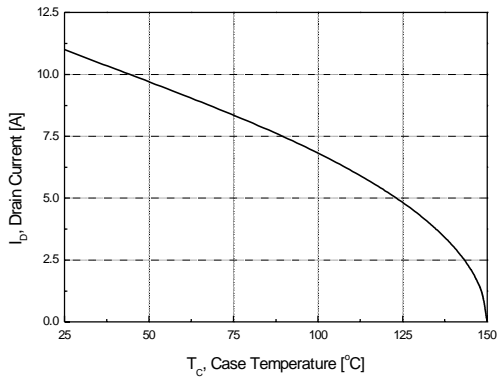

Figure 10. Maximum Drain Current vs. Case Temperature

Typical Characteristics (Continued)

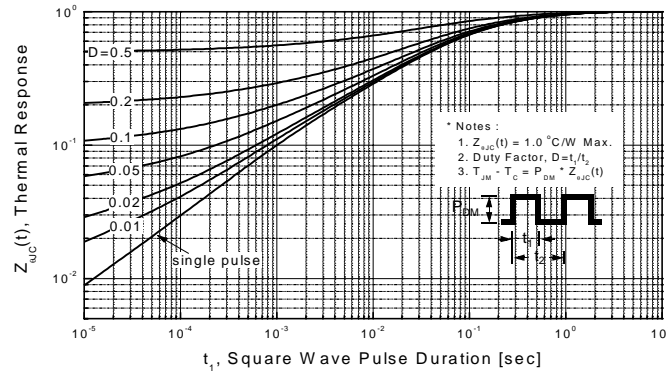

Figure 11-1. Transient Thermal Response Curve for FCP11N60

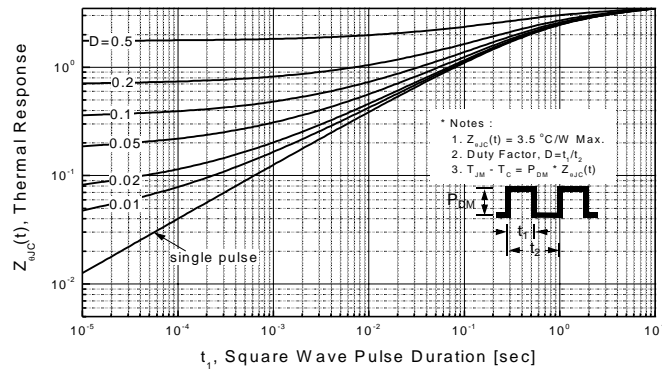

Figure 11-2. Transient Thermal Response Curve for FCPF11N60

Gate Charge Test Circuit & Waveform



Resistive Switching Test Circuit & Waveforms



Unclamped Inductive Switching Test Circuit & Waveforms



Peak Diode Recovery dv/dt Test Circuit & Waveforms



Package Dimensions

TO-220

FCP11N60/FCPF11N60

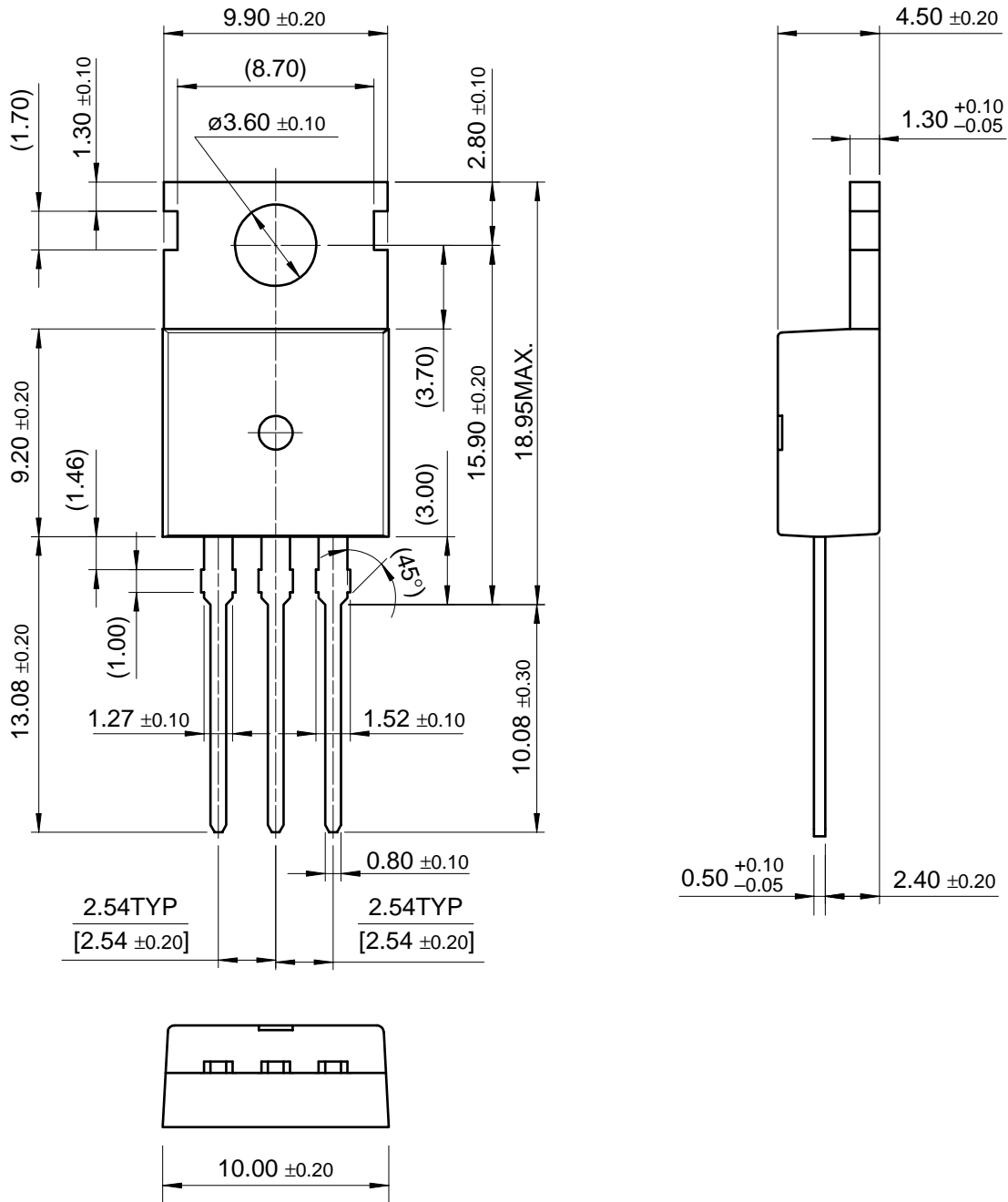

Dimensions in Millimeters

Package Dimensions

TO-220F

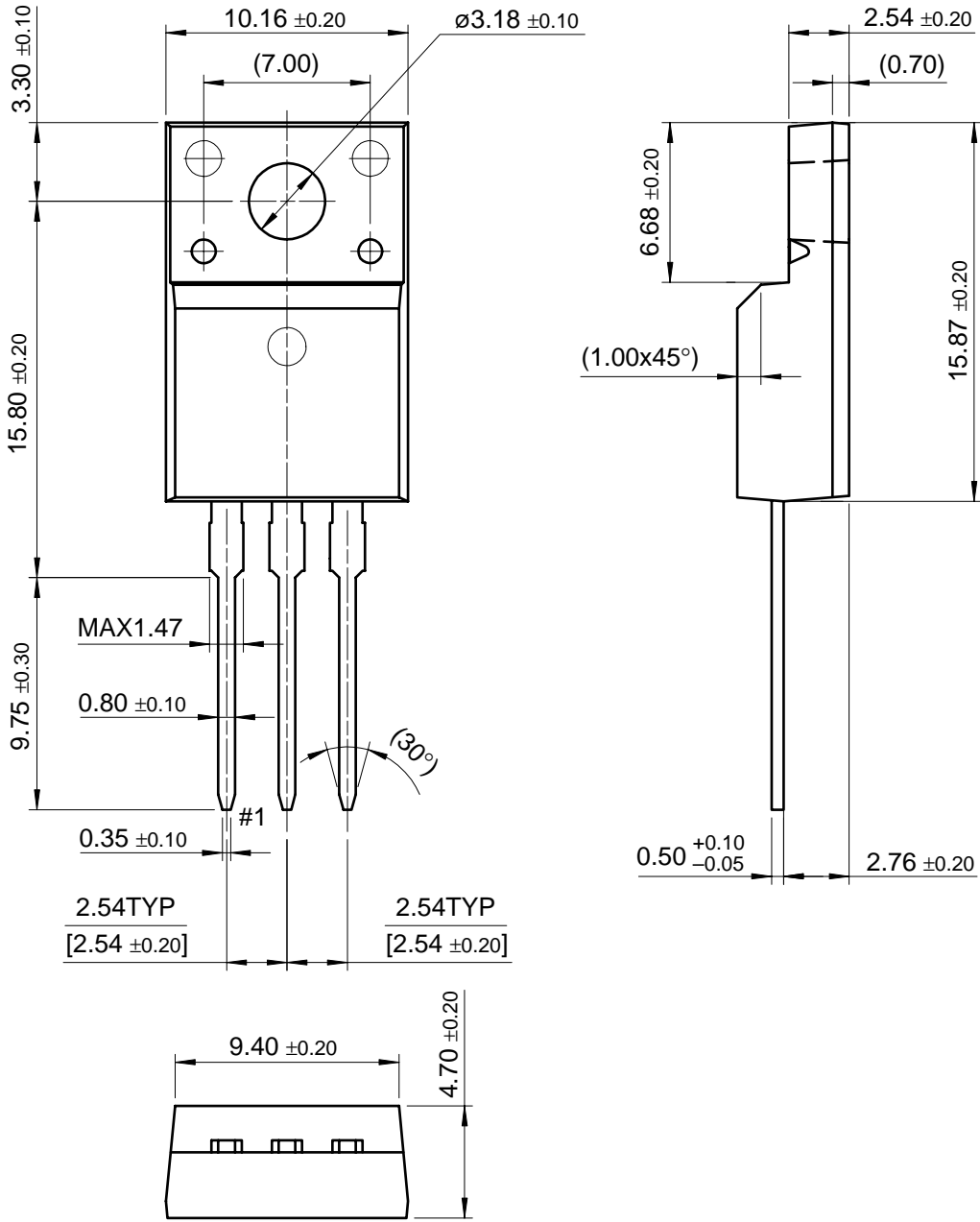

FCP11N60/FCPF11N60

Dimensions in Millimeters

TRADEMARKS

The following are registered and unregistered trademarks Fairchild Semiconductor owns or is authorized to use and is not intended to be an exhaustive list of all such trademarks.

| | | | | |
|--------------------------------------|---------------------|------------------|---------------------|-----------------|
| ACEx™ | FACT Quiet Series™ | ISOPLANAR™ | POP™ | Stealth™ |
| ActiveArray™ | FAST® | LittleFET™ | Power247™ | SuperFET™ |
| Bottomless™ | FASTr™ | MICROCOUPLER™ | PowerSaver™ | SuperSOT™-3 |
| CoolFET™ | FPST™ | MicroFET™ | PowerTrench® | SuperSOT™-6 |
| CROSSVOLT™ | FRFET™ | MicroPak™ | QFET® | SuperSOT™-8 |
| DOMET™ | GlobalOptoisolator™ | MICROWIRE™ | QS™ | SyncFET™ |
| EcoSPARK™ | GTO™ | MSX™ | QT Optoelectronics™ | TinyLogic® |
| E ² CMOS™ | HiSeC™ | MSXPro™ | Quiet Series™ | TINYOPTO™ |
| EnSigna™ | µC™ | OCX™ | RapidConfigure™ | TruTranslation™ |
| FACT™ | ImpliedDisconnect™ | OCXPro™ | RapidConnect™ | UHC™ |
| Across the board. Around the world.™ | OPTOLOGIC® | SILENT SWITCHER® | SMART START™ | UltraFET® |
| The Power Franchise™ | OPTOPLANAR™ | SPM™ | | VCX™ |
| Programmable Active Droop™ | PACMAN™ | | | |

DISCLAIMER

FAIRCHILD SEMICONDUCTOR RESERVES THE RIGHT TO MAKE CHANGES WITHOUT FURTHER NOTICE TO ANY PRODUCTS HEREIN TO IMPROVE RELIABILITY, FUNCTION OR DESIGN. FAIRCHILD DOES NOT ASSUME ANY LIABILITY ARISING OUT OF THE APPLICATION OR USE OF ANY PRODUCT OR CIRCUIT DESCRIBED HEREIN; NEITHER DOES IT CONVEY ANY LICENSE UNDER ITS PATENT RIGHTS, NOR THE RIGHTS OF OTHERS.

LIFE SUPPORT POLICY

FAIRCHILD'S PRODUCTS ARE NOT AUTHORIZED FOR USE AS CRITICAL COMPONENTS IN LIFE SUPPORT DEVICES OR SYSTEMS WITHOUT THE EXPRESS WRITTEN APPROVAL OF FAIRCHILD SEMICONDUCTOR CORPORATION.

As used herein:

1. Life support devices or systems are devices or systems which, (a) are intended for surgical implant into the body, or (b) support or sustain life, or (c) whose failure to perform when properly used in accordance with instructions for use provided in the labeling, can be reasonably expected to result in significant injury to the user.
2. A critical component is any component of a life support device or system whose failure to perform can be reasonably expected to cause the failure of the life support device or system, or to affect its safety or effectiveness.

PRODUCT STATUS DEFINITIONS

Definition of Terms

| Datasheet Identification | Product Status | Definition |
|--------------------------|------------------------|---|
| Advance Information | Formative or In Design | This datasheet contains the design specifications for product development. Specifications may change in any manner without notice. |
| Preliminary | First Production | This datasheet contains preliminary data, and supplementary data will be published at a later date. Fairchild Semiconductor reserves the right to make changes at any time without notice in order to improve design. |
| No Identification Needed | Full Production | This datasheet contains final specifications. Fairchild Semiconductor reserves the right to make changes at any time without notice in order to improve design. |
| Obsolete | Not In Production | This datasheet contains specifications on a product that has been discontinued by Fairchild semiconductor. The datasheet is printed for reference information only. |