

**PT100S16**

**DIODE**

**100A(Avg) 1600Volts**

回路図 Circuit

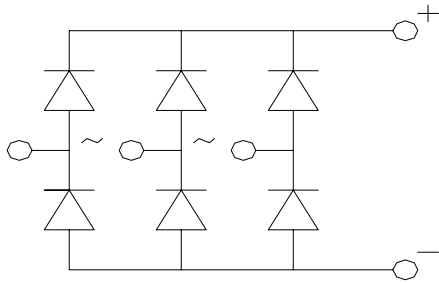

外形図 OUTLINE

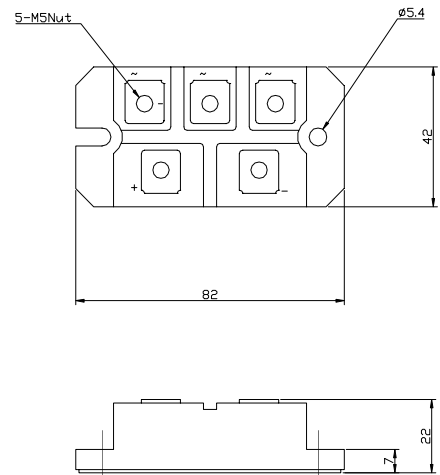

最大定格 / Maximum Ratings

質量 : Approx Net Weight:180g

Rating	Symbol	PT100S16			Unit
くり返しピーク逆電圧 *1 Repetitive Peak Reverse Voltage	$V_{RRM}$	1600			V
非くり返しピーク逆電圧 *1 Non Repetitive Peak Reverse Voltage	$V_{RSM}$	1700			
平均整流電流 Average Rectified Output Current	$I_{O(AV)}$	三相全波整流 $T_c = T_t$ (Terminal) = 70°C 3-Phase Full Wave Rectified	100	A	
サージ順電流 *1 Surge Forward Current	$I_{FSM}$	50 Hz Half Sine Wave, 1 Pulse Non-repetitive	1200	A	
電流二乗時間積 I Squared t	$I^2t$	2msec to 10msec	7200	A <sup>2</sup> s	
動作接合温度範囲 Operating Junction Temperature Range	$T_{jw}$	-40 to +125			°C
保存温度範囲 Storage Temperature Range	$T_{stg}$	-40 to +125			°C
絶縁耐圧 Isolation Voltage	Viso	端子 - 裏面ベース間, AC 1分間 Base Plate to Terminals, AC 1min	2500	V	
締付トルク Mounting torque	ベース部(mounting)	推奨値 Recommended value	M5	2.4 to 2.8	N.m
	主端子部(Terminals)		M5	2.4 to 2.8	

電氣的・熱的特性 / Electrical • Thermal Characteristics

Characteristics	Symbol	Conditions	Max.	Unit
ピーク逆電流 *1 Peak Reverse Current	$I_{RM}$	$V_{RM} = V_{RRM}$ , $T_j = 125^\circ\text{C}$	15	mA
ピーク逆電圧 *1 Peak Forward Voltage	$V_{FM}$	$I_{FM} = 100\text{A}$ , $T_j = 25^\circ\text{C}$	1.2	V
熱抵抗 Thermal Resistance	$R_{th(j-c)}$	接触部・ケース間 (トータル) Junction to Case (Total)	0.24	°C/W
接触熱抵抗 Thermal Resistance	$R_{th(c-f)}$	ケース・フィン間、サーマルコンパウンド塗布 Base Plate to Heat Sink with Thermal Compound (Total)	0.06	

\*1: 1アーム当たりの値 Value Per 1Arm

PT100S16 OUTLINE DRAWING (Dimensions in mm)

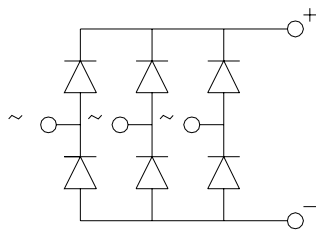
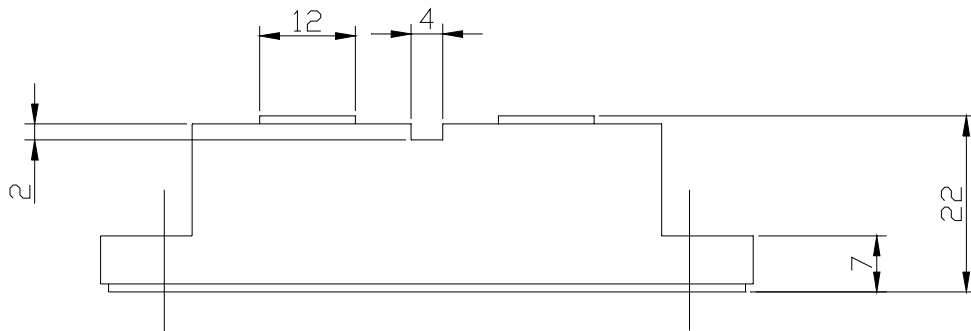
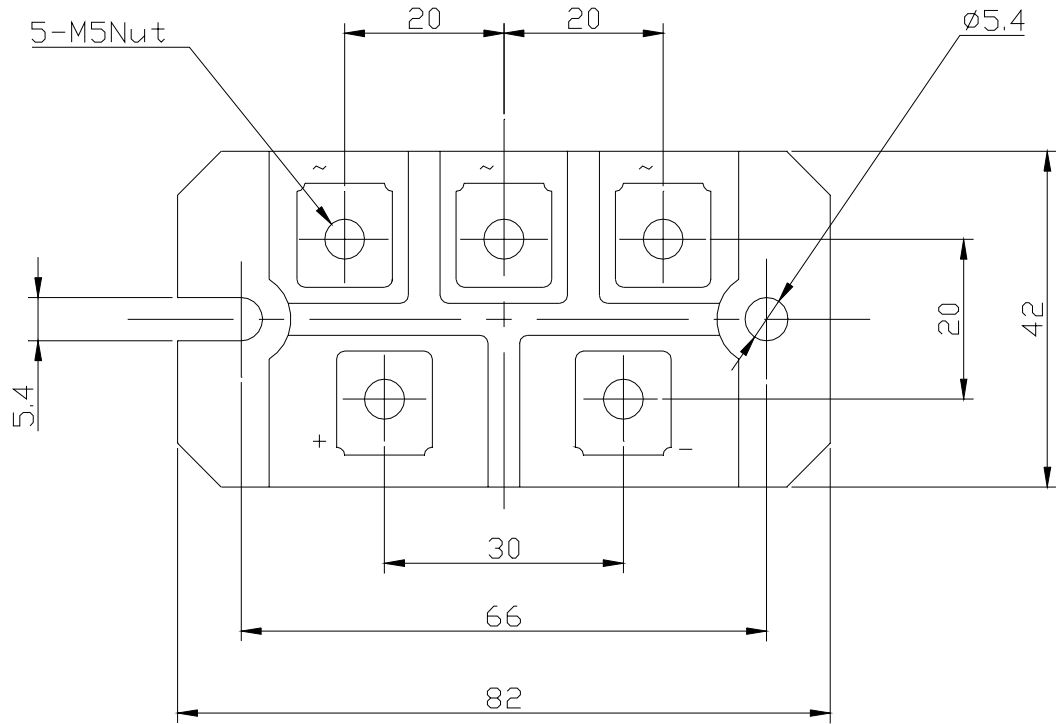

順電压特性  
FORWARD CURRENT VS. VOLTAGE

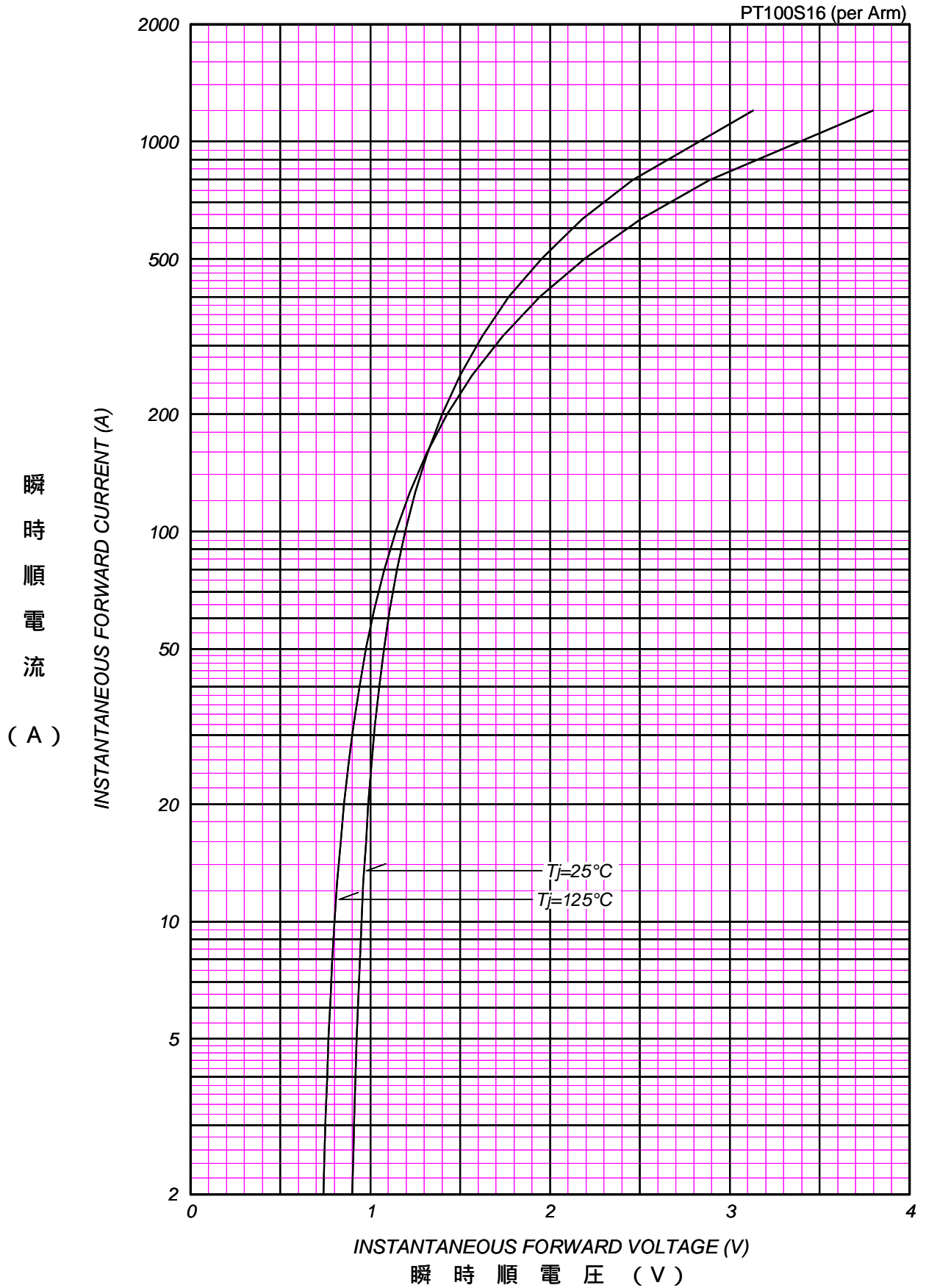

平均順電力損失特性  
AVERAGE FORWARD POWER DISSIPATION

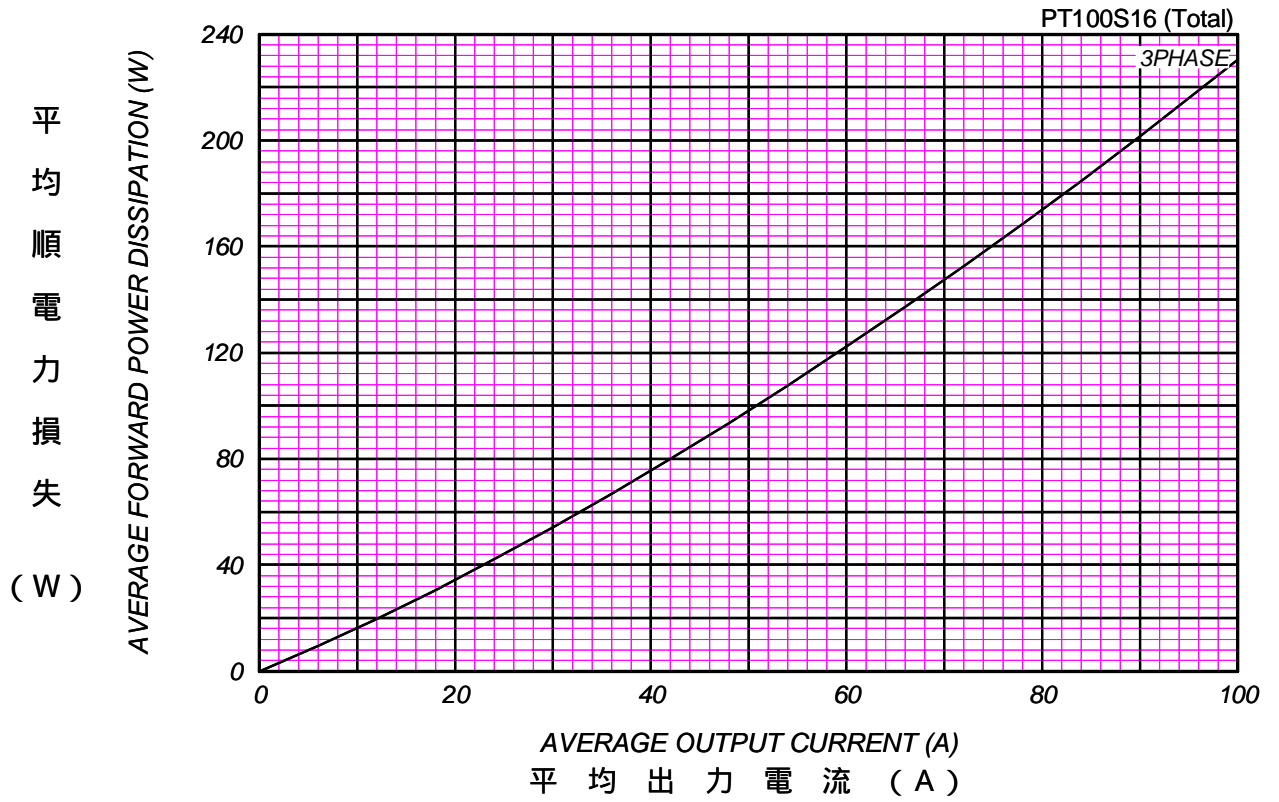

平均出力電流 - ケース温度定格  
AVERAGE OUTPUT CURRENT VS. CASE TEMPERATURE

3-Phase Full Wave, Resistive or Inductive Load

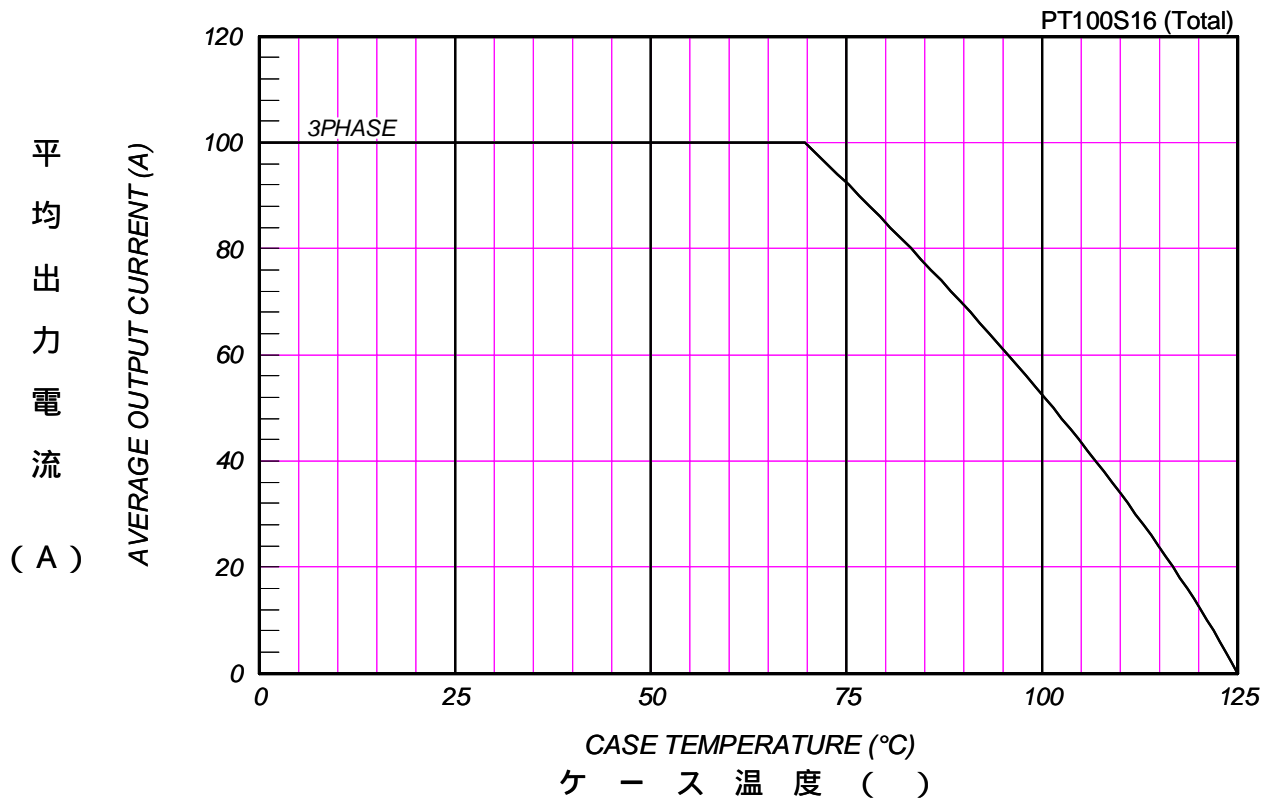

# サージ順電流定格 SURGE CURRENT RATINGS

f=50Hz, Half Sine Wave, Non-Repetitive, T<sub>j</sub>=125°C

PT100S16

